

450 (B51)

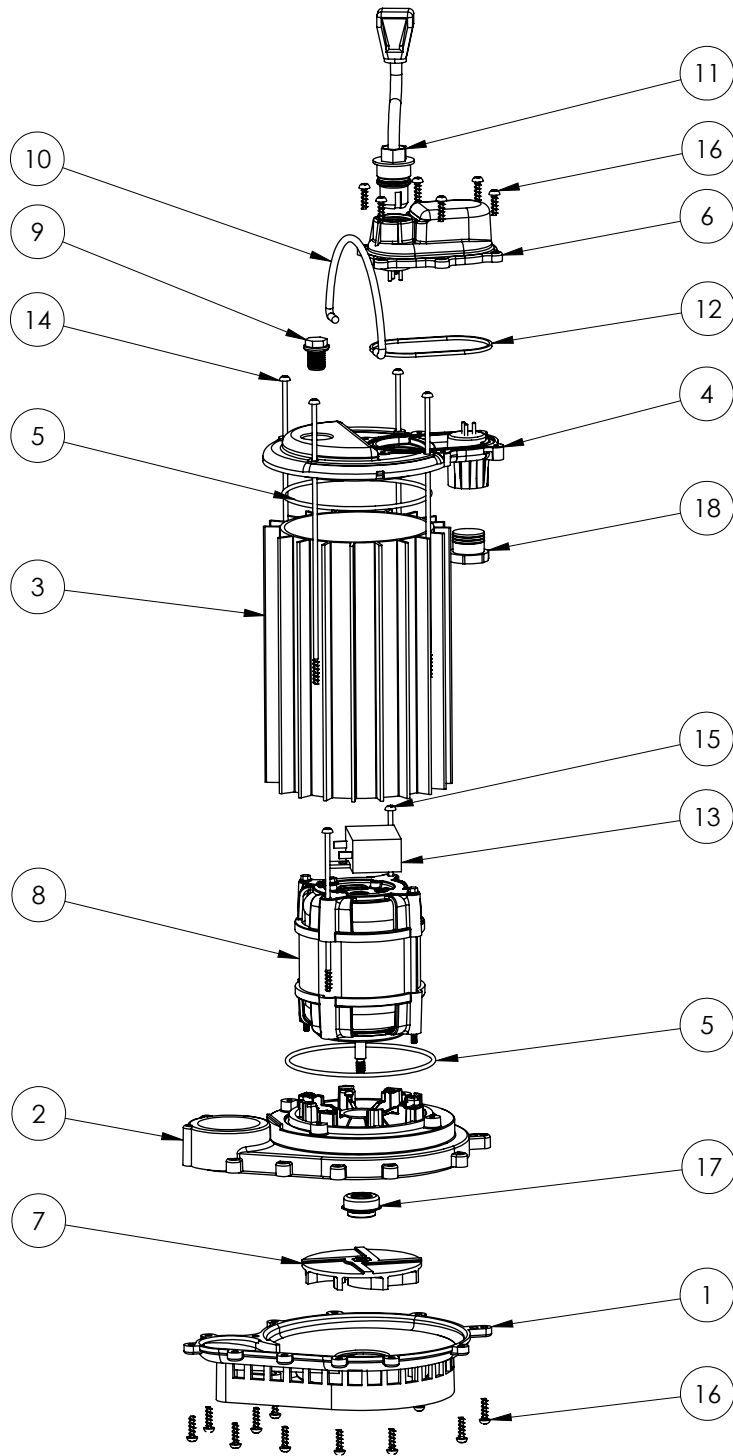

450 (B51)

#	PART #	DESCRIPTION	QTY	Note
1	233600B	BASE WITH VOLUTE ASSEMBLY	1	
2	23310AB	MOTOR SUPPORT PLATE	1	[1]
3	23070AS	MOTOR HOUSING	1	
4	240600B	MOTOR COVER	1	
5	2357000	O-RING	2	[1]
6	240700B	CHAMBER COVER	1	
7	K001168	IMPELLER	1	
8	2418200	MOTOR	1	[1]
9	8089000	OIL PLUG, O-RING ASSEMBLY	1	
10	K001082	HANDLE	1	
11	K001010	POWER CORD, 115V, 10 FOOT CORD	1	
12	K001046	SEALRING, CHAMBER COVER	1	
13	2453000	CAPACITOR	1	[1]
14	8147000	#10 x 8.4" STAINLESS STEEL SCREW	4	[1]
15	8148000	#10 x 4-3/4" POLYFAST SCREW	2	[1]
16	8104200	#10 HILO X 5/8" STAINLESS STEEL SCREW	18	
17	2309000	5/16 SHAFT SEAL	1	
18	8105000	PROTECTIVE CAP	1	

PART NOTES:

[1] - Part requires factory authorized service. Contact Liberty Pumps at 1-800-543-2550