

233-2 (B59)

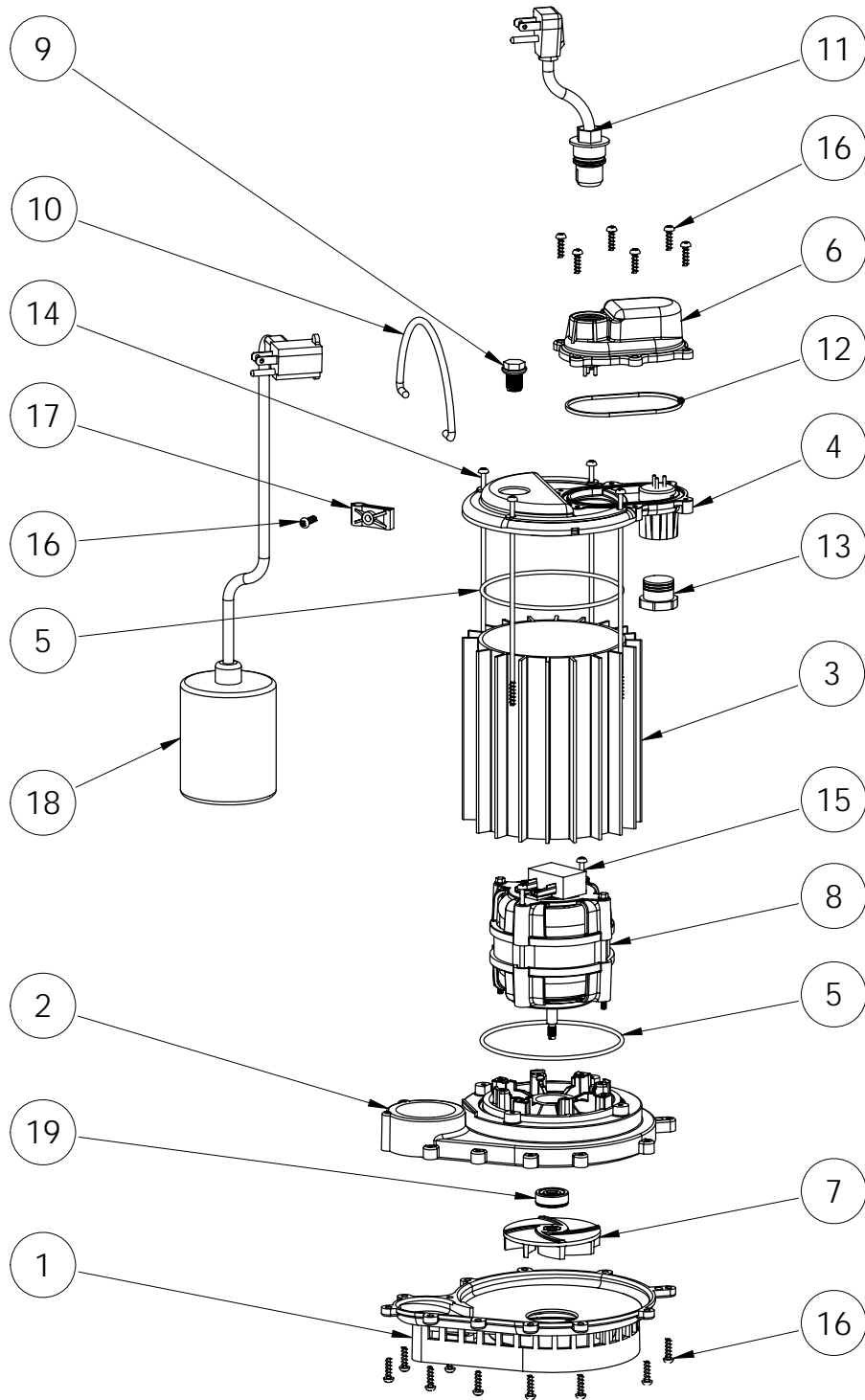

233-2 (B59)

#	PART #	DESCRIPTION	QTY	Note
1	233600B	BASE WITH VOLUTE ASSEMBLY	1	
2	23310AB	MOTOR SUPPORT PLATE	1	[1]
3	230700S	MOTOR HOUSING	1	
4	240600B	MOTOR COVER	1	
5	2357000	O-RING	2	[1]
6	240700B	CHAMBER COVER	1	
7	K001331	IMPELLER	1	
8	2415200	PSC MOTOR	1	[1]
9	8089000	OIL PLUG, O-RING ASSEMBLY	1	
10	K001082	HANDLE	1	
11	K001008	POWER CORD, 115V, 25 FOOT CORD	1	
12	K001046	SEALRING, CHAMBER COVER	1	
13	8105000	PROTECTIVE CAP	1	
14	8042200	#10 x 6-1/2 STAINLESS STEEL SCREW	4	[1]
15	8149000	#10 x 3-3/4 POLYFAST SCREW	2	[1]
16	8104200	#10 HILO X 5/8" STAINLESS STEEL SCREW	19	
17	2319000	CLAMP, SWITCH CORD	1	
18	K001144	61130B0 PUMP SWITCH, 25' 115V	1	
19	K001254	3043000 5/16" SHAFT SEAL	1	[1]

PART NOTES:

[1] - Part requires factory authorized service. Contact Liberty Pumps at 1-800-543-2550