

73. SL**SL1, SLV****SL1.50, 0.9 - 1.5 kW, SLV.65, 0.9 - 1.5 kW****Clamp**

Pos.	Kit No	96592050
	Description	
92	Clamp complete	1

Impeller

Pos.	Description	SL1.50			SLV.65		
		0.9 kW	1.1 kW	1.5 kW	0.9 kW	1.1 kW	1.5 kW
		Kit No	96115096	96115097	96115098	96115110	96115099
9a	Key 5 x 5 x 12	1	1	1	1	1	1
49	Impeller	1	1	1	1	1	1
66	Lock washer	1	1	1	1	1	1
188a	Screw M8 x 25	1	1	1	1	1	1

SmartSeal

Pos.	Kit No	96575022	96659160	96575023	96659161	
		Description	NBR	FKM	NBR	FKM
			DN 65		DN 65/80	
-	SmartSeal for guide shoe	1	1	1	1	

O-ring

Pos.	Kit No	Description	96115107	96646049
			NBR	FKM
26a	O-ring	32 x 4	1	1
37	O-ring	164 x 3	1	1
37a	O-ring	114 x 3	2	2
37b	O-ring	86 x 4	1	1
102	O-ring	19 x 1.5	2	2
107	O-ring	47 x 3	1	1
159	O-ring	32 x 2	1	1
185	O-ring	31 x 2	1	1
187	O-ring	28 x 2	1	1
194	Sealing washer		2	2
198	O-ring	34.2 x 3	1	1
-	O-ring	135 x 4 (not used)	1	1

Lifting bracket

Pos.	Description	Kit No	96690420
		Frame	1.1-1.5 kW / 1.5-2 HP
188a	Screw		2
190	Lifting bracket		1

Bearing

Pos.	Description	Kit No	98682345
		Frame	0.9-1.5 kW
153	Bearing		1
154	Bearing		1

Pin housing

Pos.	Description	Kit No
177	Pin housing with 7 poles	96778908

Plug for power connection for SL1 and SLV

Pos.	Description	Type	Connection	Kit No
176	Plug for power connection	A	1-phase	96747258
		A	Y	96747254
		A	D	96747257

Shaft seal

Pos.	Kit No	Description	96106536	96645161
			BQQP	BQQV
9a	Key		1	1
66	Lock washer		1	1
105	Shaft seal cartridge		1	1
188a	Screw M8 x 25		1	1
194	Sealing washer		2	2

Upper guide rail holder

Pos.	Kit No	96592037	96829357
		Description	DN 65/DN 80
-	Upper guide rail holder	1	1
		Before 1044 cast iron	After 1044 St. steel

SL1, 0.9 - 1.5 kW

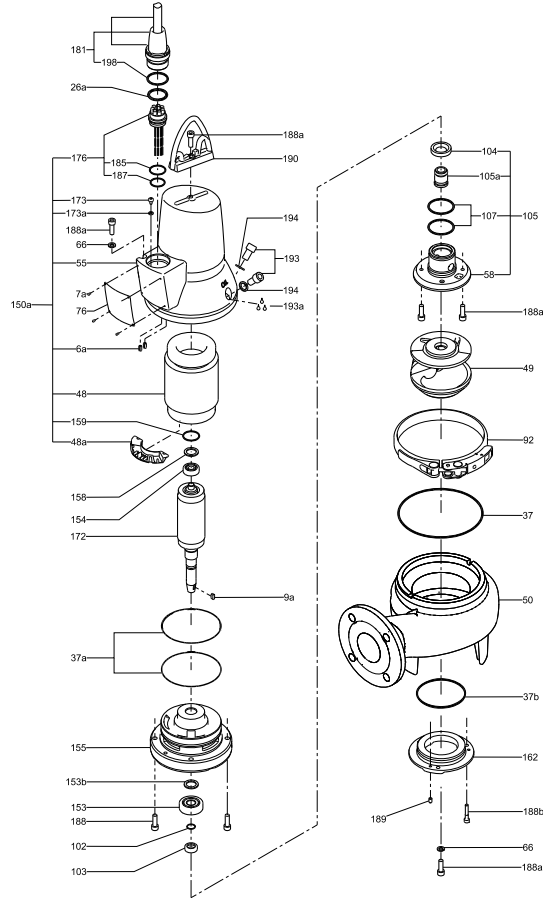

TM02 7363 0904

SLV, 0.9 - 1.5 kW

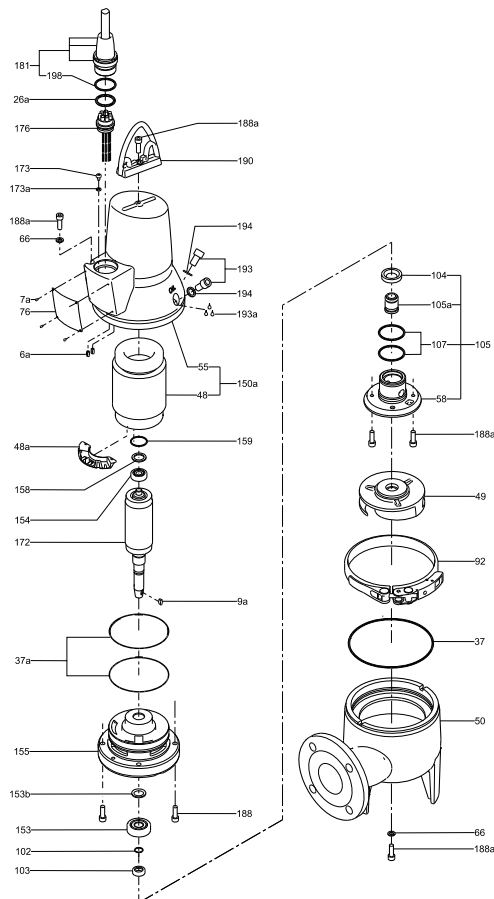

TM02 7364 0904

**SL1.50, SL1.80, SL1.100 from 2.2 kW/3 HP,
SLV.65, SLV.80, SLV.100 from 2.2 kW/3 HP****Impeller-fixing parts**

Pos.	Description	2-pole	2.2 - 4.0 kW / 3.0 - 5.5 hp	5.5 - 11.0 kW / 4.0 - 15.0 hp
		4-pole	1.1 - 2.2 kW / 1.5 - 3.0 hp	3.0 - 7.5 kW / 4.0 - 10.0 hp
		Kit No	96102365	96102366
9a	Key		1	1
66	Washer		1	1
157	Corrugated spring		1	1
188a	Screw		1	1

Single-channel Impeller

Pos.	Description	Free passage	80	50	80	50	80	50	80
		2-pole		2.2		3.0		4.0	
		4-pole	1.5		2.2		3.0		5.5
		Cast iron	96091222	96091219	96091223	96091220	96091224	96091221	96091226
49	Impeller		1	1	1	1	1	1	1
49c	Wear ring for impeller		1	1	1	1	1	1	1

Pos.	Description	Free passage	100	80	100	
		2-pole		5.5	7.5	7.5
		4-pole		96091229	96091227	96091230
		Cast iron		1	1	1
49	Impeller		1	1	1	
49c	Wear ring for impeller		1	1	1	

SuperVortex impeller

Pos.	Description	Free passage	65	80	65	80	100	65.40/80.40	80.40
		2-pole	2.2		3.0	3.0	4.0		
		4-pole		2.2		3.0		4	
		Cast iron	96886437	96812794	96886439	96886439	96886453	96886441	-
49	Impeller	Stainless steel	-	97759200	-	97759206	-	97759201	1

Pos.	Description	Free passage	100	100	80	100	80	80		
		2-pole		4.0	5.5	6.0	7.5	7.5	9.2	
		4-pole		96886456	96882380	96812823	96812827	96882475	96812831	96812654
		Cast iron	96886456	96882380	96812823	96812827	96882475	96812831	96812654	
49	Impeller	Stainless steel	97759207	97759208	97759202	97759203	97759209	97759204	97759205	

S-tube impeller

Pos.	Description	SL1.50	SL1.50	SL1.50	SL1.80	SL1.80	SL1.80	SL1.80
		2-pole	2.2	3.0	4.0			
		4-pole				1.5	2.2	3.0
49	Impeller	98166759	98166760	98166771	98166772	98166773	98166774	98166775
49c	Wear ring for impeller	1	1	1	1	1	1	1

Pos.	Description	SL1.80	SL1.80	SL1.100	SL1.100	SL1.100
		2-pole				
		4-pole	5.5	7.5	4.0	5.5
49	Impeller	98166776	98166777	98166778	98166779	98166780
49c	Wear ring for impeller	1	1	1	1	1

Tube impeller "Generation A"

Pos.	Description	SL1 100.75.4
		97783819
49	Impeller 50Hz SE1.100.75.4, tube catph.	1
49C	Wear ring for impeller SE1.100	1
58	Cover for oil chamber D, D235, catap	1

SL1 without sensor

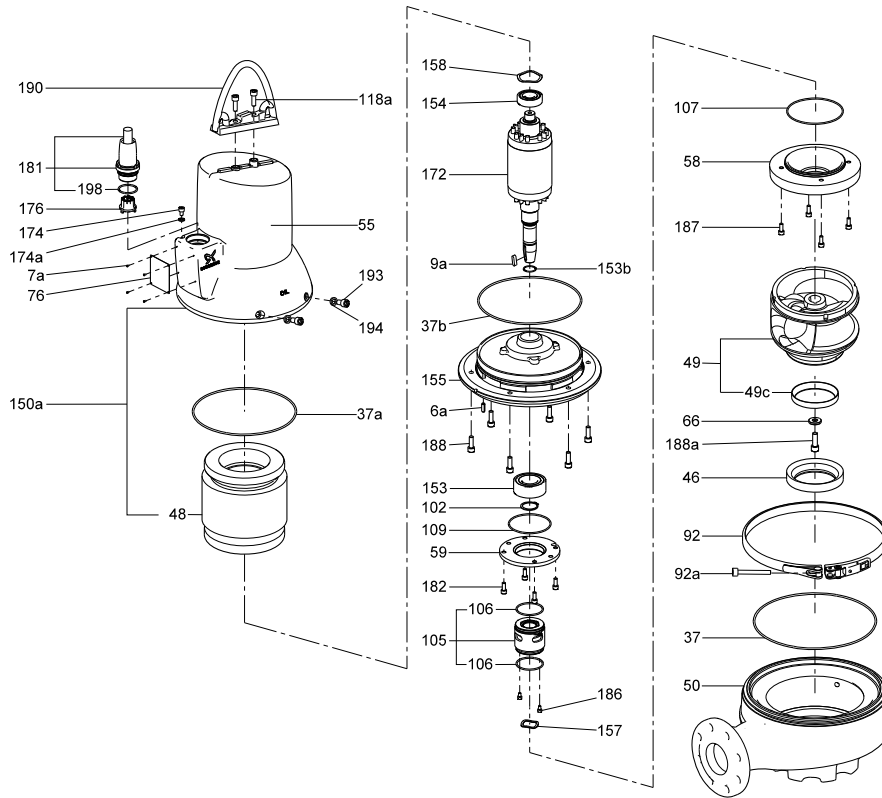

TM04 2777 2605

SL1 with sensors

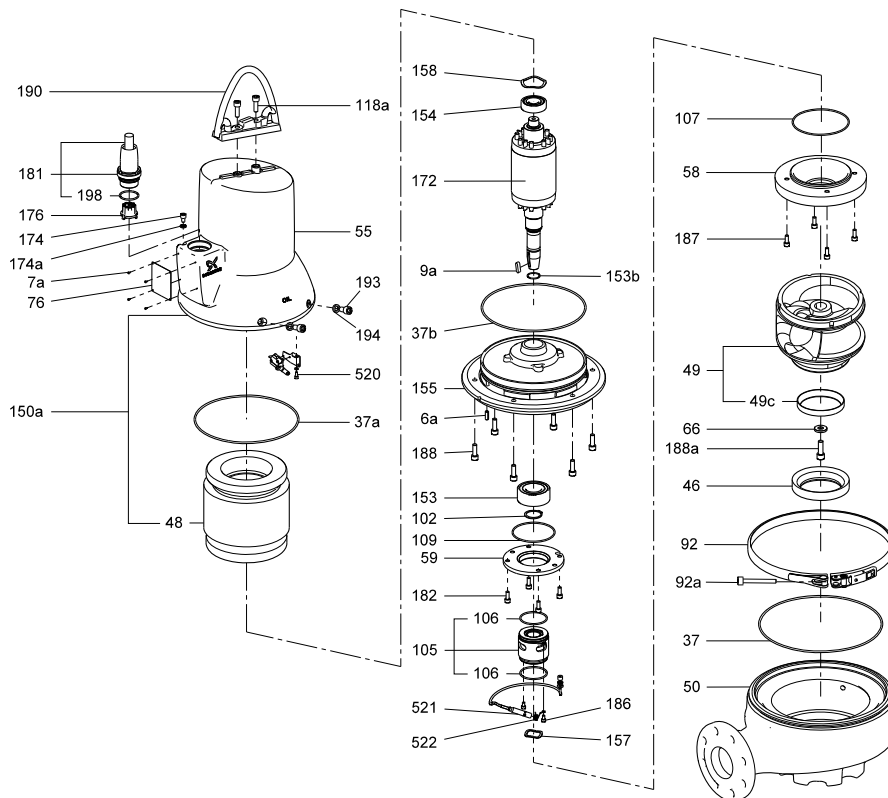

TM04 2778 2908

Upgrade from single-channel impeller to S-tube impeller

Kit No	NBR	50.65.22.2	50.80.22.2	50.65.30.2	50.80.30.2	50.65.40.2	50.80.40.2	80.80.15.4	80.100.15.4	80.80.22.4
		FKM	98173157	98173160	98173161	98173197	98173198	98173199	98173200	98173211
Pos.	Description	1	1	1	1	1	1			
46	Wear ring for impeller	1	1	1	1	1	1	1	1	1
58	Cover for oil chamber	1	1	1	1	1	1	1	1	1
49	Impeller	1	1	1	1	1	1	1	1	1
49c	Seal ring	1	1	1	1	1	1	1	1	1
50	Pump-housing	1	1	1	1	1	1	1	1	1
58a	Spring pin	4	4	4	4	4	4	1	1	1
187	Socket head cap screw							4	4	4

Kit No	NBR	80.100.22.4	80.80.30.4	80.100.30.4	80.80.40.4	80.100.40.4	80.80.55.4	80.100.55.4	80.80.75.4	80.100.75.4
		FKM	98173214	98173215	98173216	98173217	98173218	98173219	98173221	98173222
Pos.	Description	1	1	1	1	1	1	1	1	1
46	Wear ring for impeller	1	1	1	1	1	1	1	1	1
58	Cover for oil chamber	1	1	1	1	1	1	1	1	1
49	Impeller	1	1	1	1	1	1	1	1	1
49c	Seal ring	1	1	1	1	1	1	1	1	1
50	Pump-housing	1	1	1	1	1	1	1	1	1
58a	Spring pin	1	1	1	1	1	1	1	1	1
187	Socket head cap screw	4	4	4	4	4	4	4	4	4

Kit No	NBR	100.100.40.4	100.150.40.4	100.100.55.4	100.150.55.4	100.100.75.4	100.150.75.4
		FKM	98173225	98173226	98173227	98173228	98173230
Pos.	Description	1	1	1	1	1	1
46	Wear ring for impeller	1	1	1	1	1	1
58	Cover for oil chamber	1	1	1	1	1	1
49	Impeller	1	1	1	1	1	1
49c	Seal ring	1	1	1	1	1	1
50	Pump-housing	1	1	1	1	1	1
58a	Spring pin	1	1	1	1	1	1
187	Socket head cap screw	4	4	4	4	4	4

Wear ring (SL1)

Pos.	Description	Free passage				Free passage				
		Ø50				Ø80				
		Single-channel impeller		S-tube impeller		Single-channel impeller		S-tube impeller		
		Rubber type	NBR	FKM		NBR	FKM	NBR	FKM	
		2 - pole				98166805 98172401				
		4 - pole				96102362 96690568 96102363 96690569 98166806 98172402				
46	Seal ring		1	1			1	1	1	1
49c	Wear ring		1	1			1	1	1	1

Pos.	Description	Free passage				Free passage				
		Ø100								
		Single-channel impeller		S-tube impeller						
		Rubber type	NBR	FKM		NBR	FKM			
		2 - pole								
		4 - pole				96102364 96690570 98166807 98172403				
46	Seal ring		1	1			1	1	1	1
49c	Wear ring		1	1			1	1	1	1

SLV without sensor

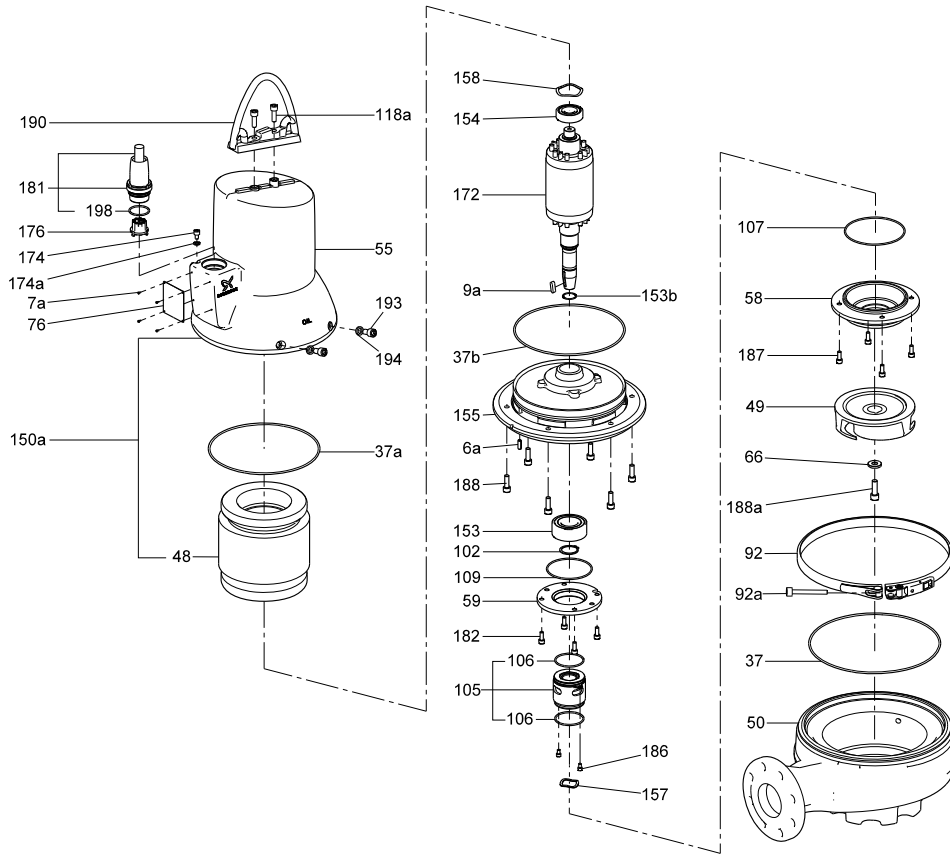

TM04 2779 2908

SLV with sensors

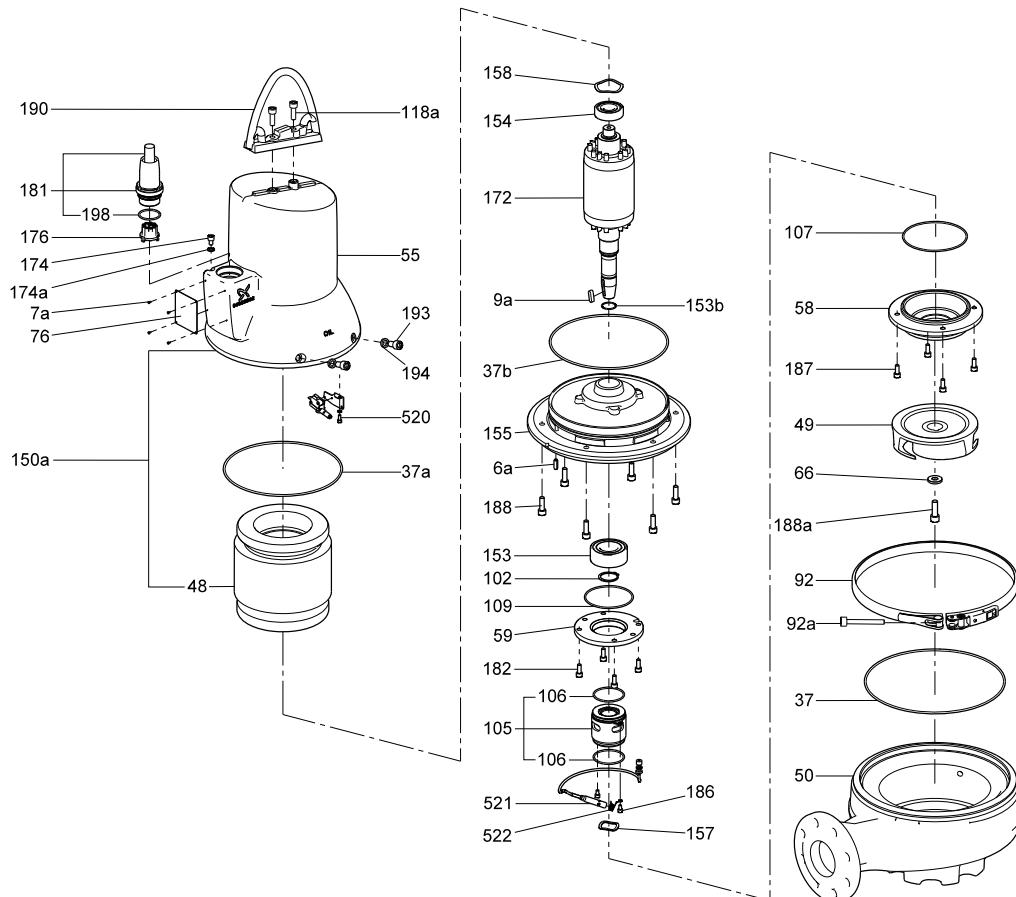

TM04 2780 2908

**SL1.50, SL1.80, SL1.100 from 2.2 kW/3 HP,
SLV.65, SLV.80, SLV.100 from 2.2 kW/3 HP****Moisture switch**

Pos.	Description	Kit No
		96817995
	Moisture switch calibrated	1
	Screw	2
	Nut	2
520	Connector	3
	Connector	3
	Screw combined slot torx straight	2
	Guard for moisture switch	1

O-ring

Pos.	Description	2-pole	2.2 - 3.0 kW / 1.5 - 3 HP	4.0 kW / 5.5 HP	6.0 - 7.5 kW / 8-10 HP	9.2 - 11 kW / 12.5 - 15 HP
		4-pole	1.1 - 2.2 kW / 1.5 - 3 HP	-	3.0 - 5.5 kW / 4 - 7.5 HP	7.5 kW / 10 HP
		NBR, Kit No	96873520	96873521	96873542	96873543
37	O-ring		1	1	1	1
37a	O-ring		1	1	1	1
37b	O-ring		1	1	1	1
102	O-ring		1	1	1	1
106	O-ring		2	2	2	2
107	O-ring		1	1	1	1
109	O-ring		1	1	1	1
194	Sealing washer		2	2	2	2
198	O-ring		1	1	1	1

Shaft seal

Pos.	Description	2-pole	2.2 - 4.0 kW / 3 - 5.5 HP	6.0 - 11 kW / 8 - 15 HP
		4-pole	1.1 - 2.2 kW / 1.5 - 3.0 HP	3.0 - 7.5 kW / 4 - 10 HP
		Rubber type	NBR	NBR
		Kit No	96102360	96102361
105	Shaft seal cartridge		1	1
107	O-ring	110 x 3	1	1
		134.5 x 3	1	1
		160 x 3	1	1
153b	O-ring	17.0 x 2.4	1	1
		28 x 2	1	1
157	Corrugated spring		1	1

Wear rings (SL1)

Pos.	Description	Free passage	Ø50/2"	Ø80/3"	Ø100/4"
		Rubber type	NBR	NBR	NBR
		Kit No	96102362	96102363	96102364
46	Seal ring		1	1	1
49c	Wear ring		1	1	1

SL1 without sensor

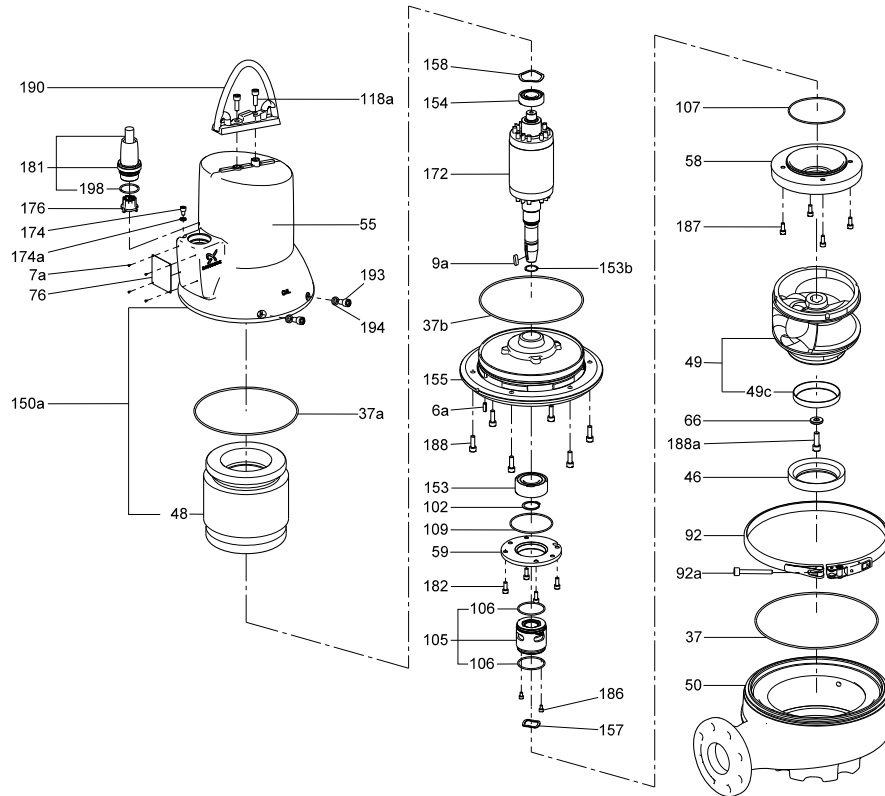

TM04 2777 2605

SL1 with sensors

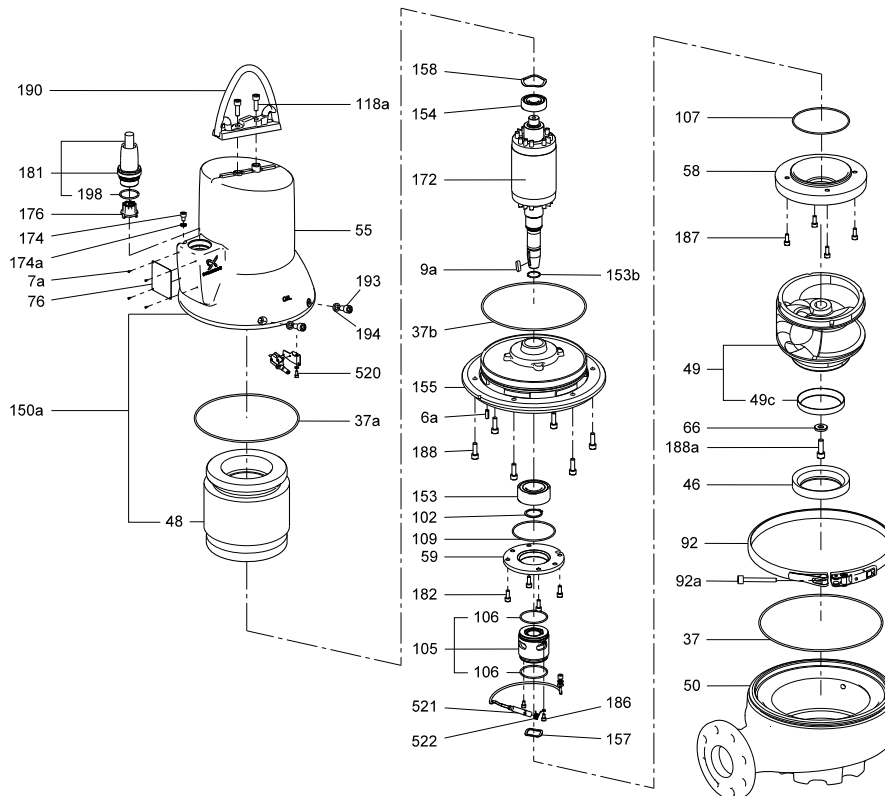

TM04 2778 2908

Bearing

Pos.	Description	2-pole	2.2 - 3.0 kW / 3 - 4 HP	4.0 - 7.5 kW / 5.5 - 10 HP	9.2 - 11 kW / 12.5 - 15 HP
		4-pole	1.1 - 2.2 kW / 1.5 - 3 HP	3.0 - 5.5 kW / 4 - 7.5 HP	7.5 kW / 10 HP
		Kit No	96690703	96904928	96690705
153	Bearing D-end	1	1	1	1
154	Bearing N-end	1	1	1	1

Clamp

Pos.	Description	2-pole	2.2 - 3.0 kW / 3 - 4 HP	4.0 - 7.5 kW / 5.5 - 10 HP	9.2 - 11 kW / 12.5 - 15 HP
		4-pole	1.1 - 2.2 kW / 1.5 - 3 HP	3.0 - 5.5 kW / 4 - 7.5 HP	7.5 kW / 10 HP
		Kit No	96592061	96592063	96592064
92	Clamp	1	1	1	1

Guide shoe

Description	Outlet	DN 80	DN 80/100	DN 100	DN 100/150	DN 150
	Rubber type	NBR	NBR	NBR	NBR	NBR
	Kit No	96592058	96611611	96592056	96611613	96592060
Guide shoe		1	1	1	1	1
SmartSeal		1	1	1	1	1

Lifting bracket

Pos.	Description	2-pole	2.2 - 4 kW / 3 - 5.5 HP	6 - 11 kW / 8 - 15 HP
		4-pole	1.1 - 4 kW / 1.5 - 5.5 HP	5.5 - 7.5 kW / 7.5 - 10 HP
		Kit No	96873469	96873519
190	Lifting bracket	1	1	1
188a	Screw	2	2	2

SmartSeal for auto coupling

Description	Outlet	DN 65	DN 65/80	DN 80	DN 80/100	DN 100	DN 100/150	DN 150
	Rubber type	NBR	NBR	NBR	NBR	NBR	NBR	NBR
	Kit No	96575022	96575023	96575024	96575025	96575027	96575028	96575029
SmartSeal		1	1	1	1	1	1	1

Lifting bracket

Pos.	Description	Kit No	96690428
		Frame	2.2 - 3 kW, 2-pole / 3-4 HP 1.5 - 2.2 kW, 4-pole / 2-3 HP
		188a	Screw
190	Lifting bracket	1	

Water-in-oil sensor

Pos.	Description	Type	50 Hz	60 Hz
			ATEX-approved	FM-approved
		Kit No	96904929	97717977
	Disc spring		4	4
	Rubber bush		1	1
521	Washer for cable-entry		1	1
	Sensor holder		1	1
	Sensor unit complete		1	1

SLV without sensor

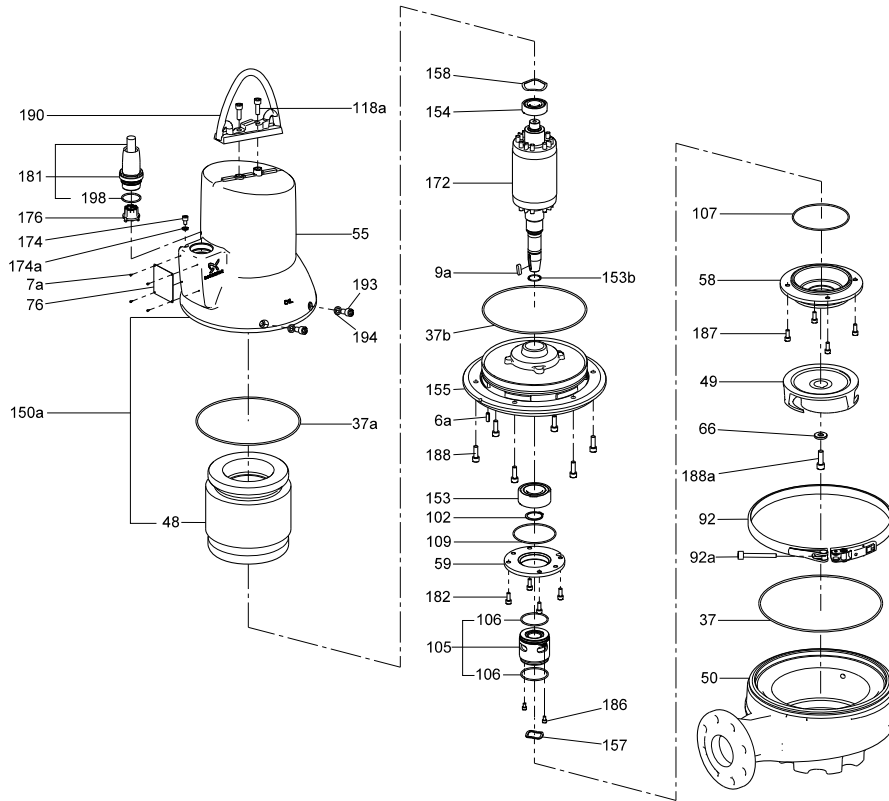

TM04 2779 2908

SLV with sensors

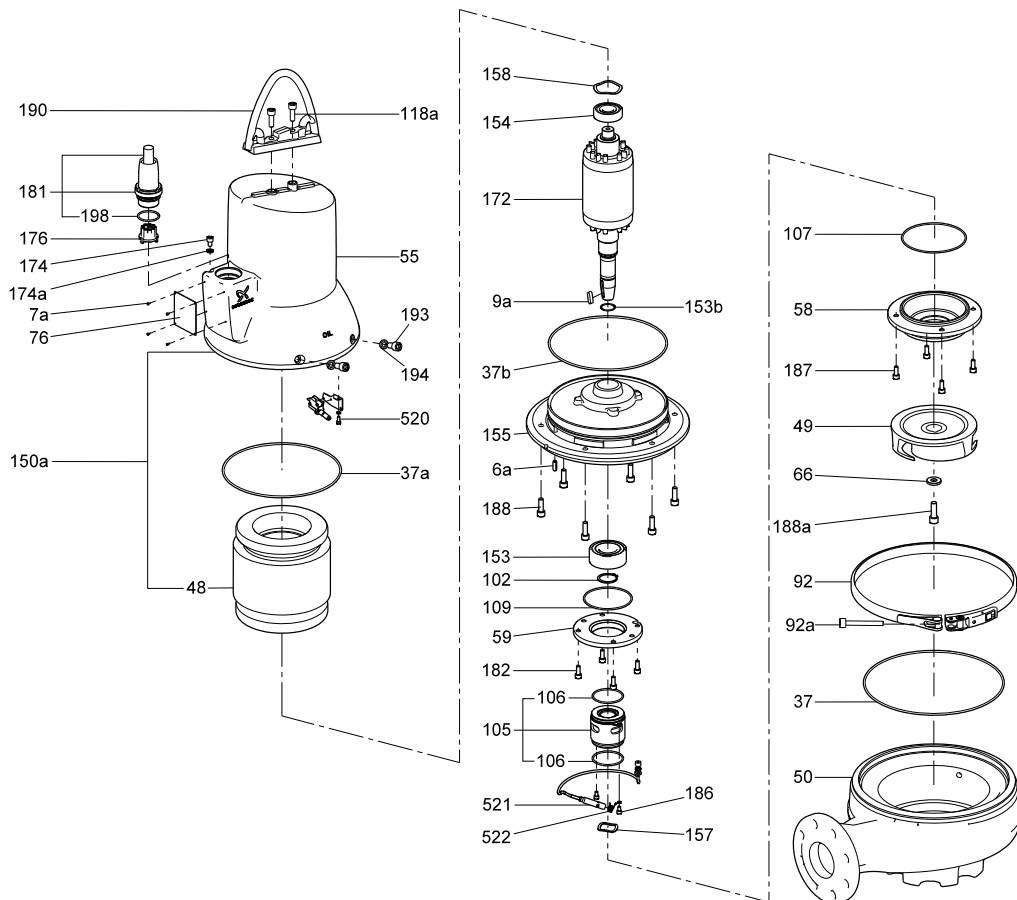

TM04 2780 2908

Cable, 50 Hz

Pos.	Description/length	10 m	15 m	20 m	25 m	
181	Standard	96591649	96659473	96591660	96689953	
	2.2-3 kW, 2-pole / 3-4 HP	Standard D	-	-	-	
	1.5-2.2 kW, 4-pole / 2-3 HP	Ex	96689976	96689977	96689978	96689979
		Ex D	-	-	-	-
	Screened Ex	96102486	96689980	96102488	96102489	
	Standard	96689954	96689955	96689956	96689957	
	Standard D	96689958	96689959	96689970	96689971	
	6-11 kW, 2-pole / 8-15 HP, 2-pole	Ex	96102482	96102483	96102484	96102485
		Ex D	96102498	96102499	96102500	96102501
	3-7.5 kW, 4-pole / 4-10 HP, 4-pole	Screened Ex D	96102490	96102491	96102492	96102493
		Screened Ex Y	96769058	96769060	96769061	96769062

Cable, 60 Hz

Pos.	Description/length	10 m / 33 ft	15 m / 49 ft	20 m / 66 ft	25 m / 82 ft	
181	7 x 1.5 mm ² /AWG16 DOL					
	2.2-3 kW, 2-pole / 3-4 HP, 2-pole	Standard	97634728	97634909	97634910	97634911
	1.5-2.2 kW, 4-pole / 2-3 HP, 4-pole	Ex	97634729	97634933	97634934	97634935
		Screened Ex	97634730	97634957	97634958	97634959
	4 x 2.5 mm ² /AWG14 + 3 x 1.5 mm ² /AWG16 DOL					
	6-7.5 kW, 2-pole / 8-10 HP, 2-pole	Standard	97634902	97634921	97634922	97634923
		Ex	97634905	97634945	97634946	97634947
	3-5.5 kW, 4-pole / 4-7.5 HP, 4-pole	Screened Ex D	97634908	97634969	97634970	97634971
		Screened Ex Y	97634907	97634963	97634964	97634965
	7 x 2.5 mm ² /AWG14 + 3 x 1.5 mm ² /AWG16 SD					
	9.2-11 kW, 2-pole / 12-15 HP, 2-pole	Standard	97634903	97634927	97634928	97634929
		Ex	97634906	97634951	97634952	97634953
7.5 kW, 4-pole / 10 HP, 4-pole	Screened Ex D	97634908	97634969	97634970	97634971	
	Screened Ex Y	97634907	97634963	97634964	97634965	

Pin housing

Pos.	Description	Kit No
177	Pin housing with 7 poles	96778908
	Pin housing with 7 connector pins in 10-pole housing	97769613
	Pin housing with 10 poles	96778912

Upper guide rail holder

Pos.	Kit No	96592037	96829357	96592038	96829358
	Description	DN 65/DN 80	DN 65/DN 80	DN 100/DN 150	DN 100/DN 150
-	Upper guide rail holder	1	1	1	1
		Before 1044 cast iron	After 1044 st. steel	Before 1044 cast iron	After 1044 st. steel

SLV without sensor

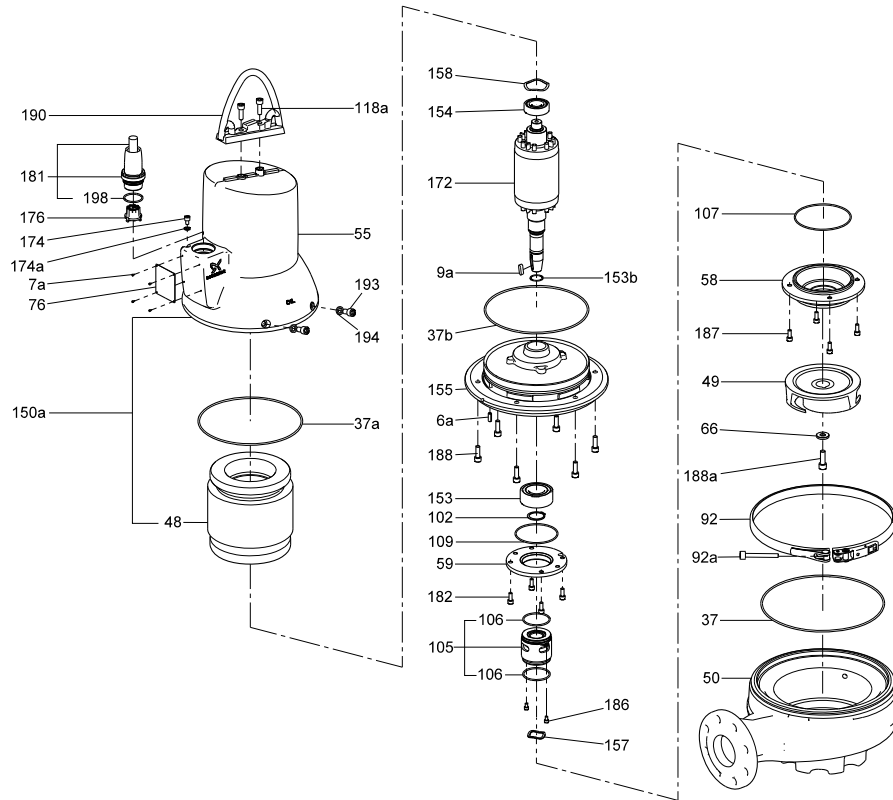

TM04 2779 2908

SLV with sensors

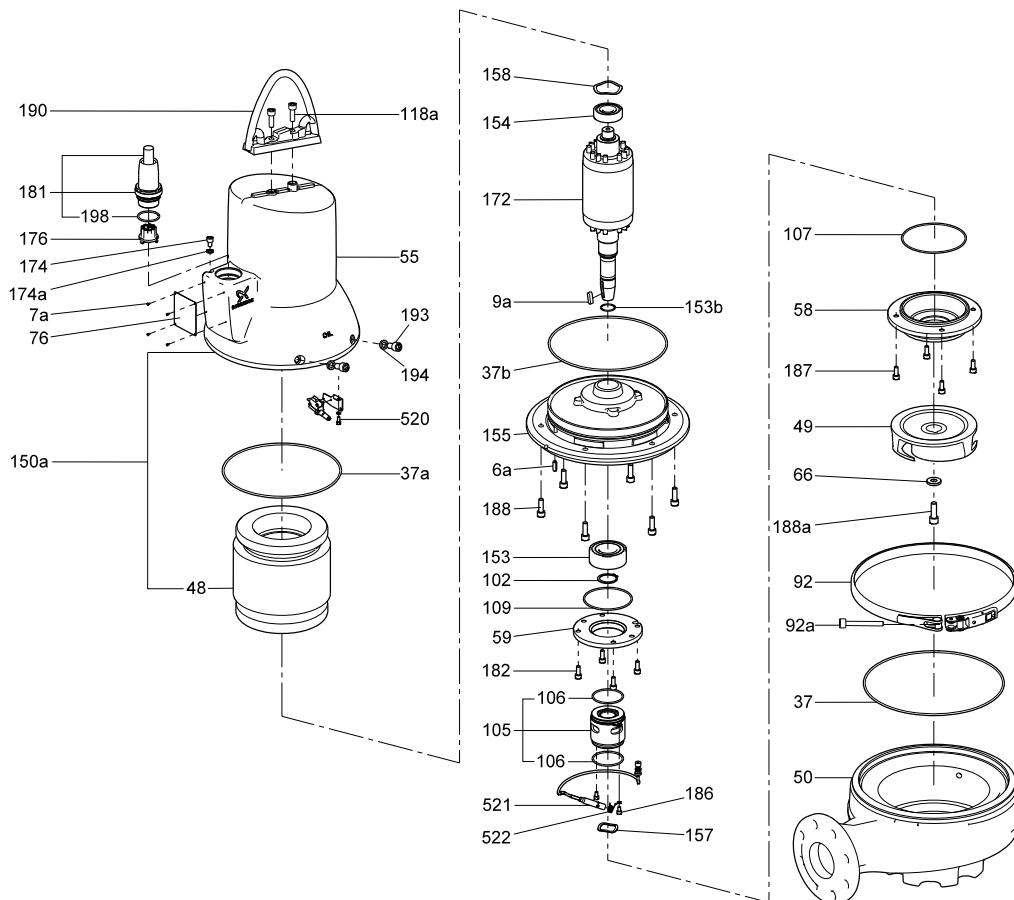

TM04 2780 2908

SL 1, SLV AUTOADAPT**50 Hz****Bearing**

Pos.	Description	Type	0.9-1.5 kW
		Kit No	98682345
153	Bearing		1
154	Bearing		1

Clamp

Pos.	Kit No	96592050
	Description	
92	Clamp complete	1

Lifting bracket

Pos.	Description	Kit No	96984147
188a	Screw M8 x 25		1
190	Lifting bracket		1

Impeller

Pos.	Description	SL1.50			SLV.65		
		0.90 kW	1.1 kW	1.5 kW	0.9 kW	1.1 kW	1.5 kW
		Kit No	96115096	96115097	96115098	96115110	96115099
9a	Key 5 x 5 x 12	1	1	1	1	1	1
49	Impeller	1	1	1	1	1	1
66	Lock washer	1	1	1	1	1	1
188a	Screw M8 x 25	1	1	1	1	1	1

O-ring

Pos.	Description	0.9 - 1.5 kW	
		NBR	FKM
		Kit No	96115107
26a	O-ring	1	1
37	O-ring	1	1
37a	O-ring	2	2
102	O-ring	2	2
107	O-ring	1	1
159	O-ring	1	1
185	O-ring	1	1
187	O-ring	1	1
194	Sealing washer	2	2
198	O-ring	1	1
532	Silica gel	1	1

SmartSeal

Pos.	Kit No	96575022	96659160
	Description	NBR	FKM
	DN 65		
-	SmartSeal for guide shoe	1	1

Shaft seal

Pos.	Kit No	96106536	96645161
	Description	BQQP	BQQV
	9a	Key	1
66	Lock washer	1	1
105	Shaft seal cartridge	1	1
188a	Screw M8 x 25	1	1
194	Sealing washer	2	2

Upper guide rail holder

Pos.	Kit No	96829357
	Description	DN 65/DN 80
-	Upper guide rail holder	1

SL1.50

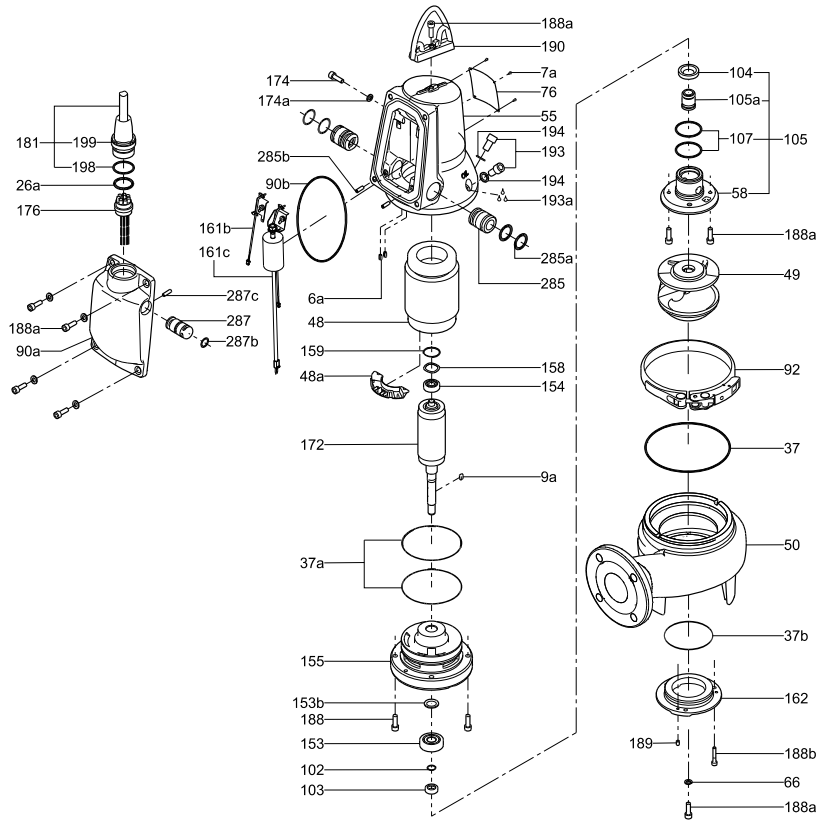

SLV.65

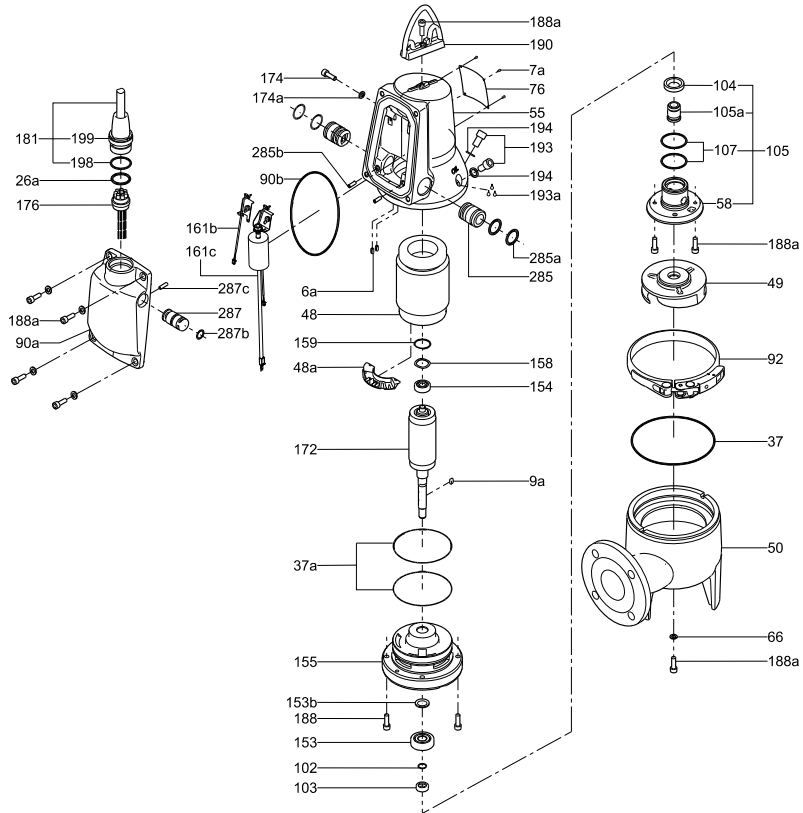

TM04 4799 2109

TM04 4800 2109

Cable

Pos.	Description	Length Type	10		15		20		25	
			Standard	Ex	Standard	Ex	Standard	Ex	Standard	Ex
181	Cable		96591649	96689976	96659473	96689977	96591660	96689978	96689953	96689979

Dry running sensor

Pos.	Description	Type Kit No	Standard	Ex
			96898083	96984131
90b	O-ring 180 x 4		1	2
285	Dry-running sensor		1	1
285a	O-ring 30 x 3		2	1
285b	Set screw for sensor housing M6 x 18		1	1

Electronic controller

Pos.	Description	Type	Standard 1-ph.	Ex 1-ph.	Standard 3-ph.	Ex 3-ph.	
			2-pole	0.9 - 1.1 kW	0.9 - 1.1 kW	0.9 - 1.5 kW	0.9 - 1.5 kW
			Kit No	96898085	96984145	96898086	96984146
90a	Cover with electronic unit		1	1	1	1	
90b	O-ring 180 x 4		1	1	1	1	

Level sensor

Pos.	Description	Type Kit No	Standard	Ex
			96898082	96984130
90b	O-ring 180 x 4		1	1
287	Level sensor		1	1
287b	O-ring 20 x 3		1	1
287c	Set screw for sensor housing M6 x 18		1	1

Power plug

Pos.	Description	Type	Standard and Ex
		Kit No	96984144
90b	O-ring 180 x 4		1
181	Outer plug for power connection		1

PT1000 with bracket

Pos.	Description	Type	Standard 3-ph. and Ex
		Kit No	97698437
161b	PT1000 sensor with bracket		1
90b	O-ring 180 x 4		1

Run capacitor

Pos.	Description	Kit No	96898084
90b	O-ring 180 x 4		1
-	Hexagon nut M8		1
161c	Bracket with capacitor		1
161d	Star washer		1
161f	Screw M5 x10		1
288	Pt1000 sensor		1
-	Cable strip		2

SL1.50

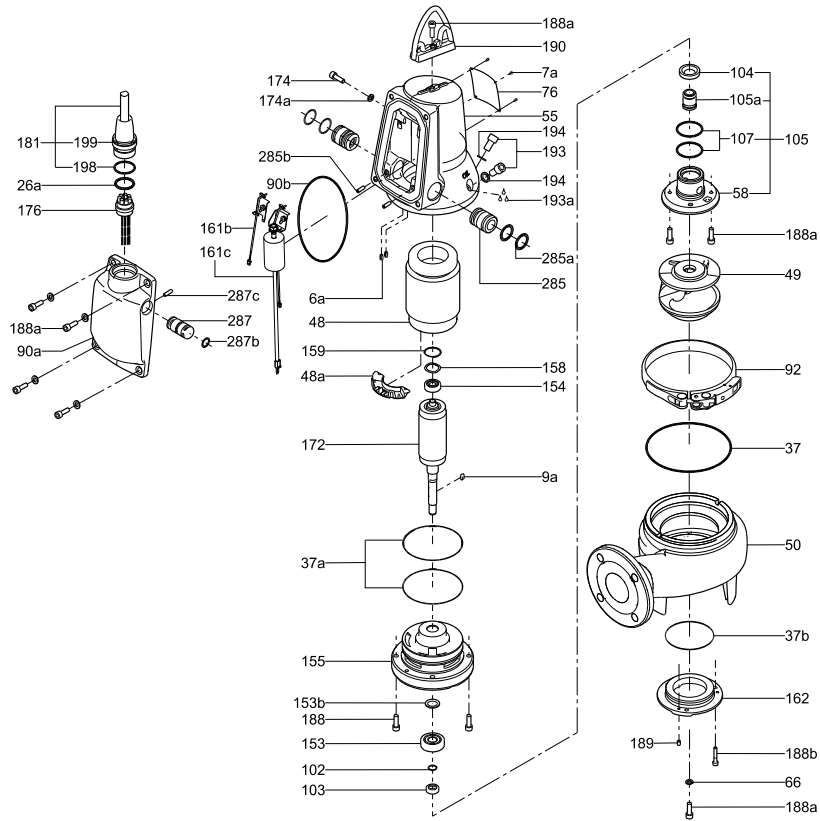

TM04 4799 2109

SLV.65

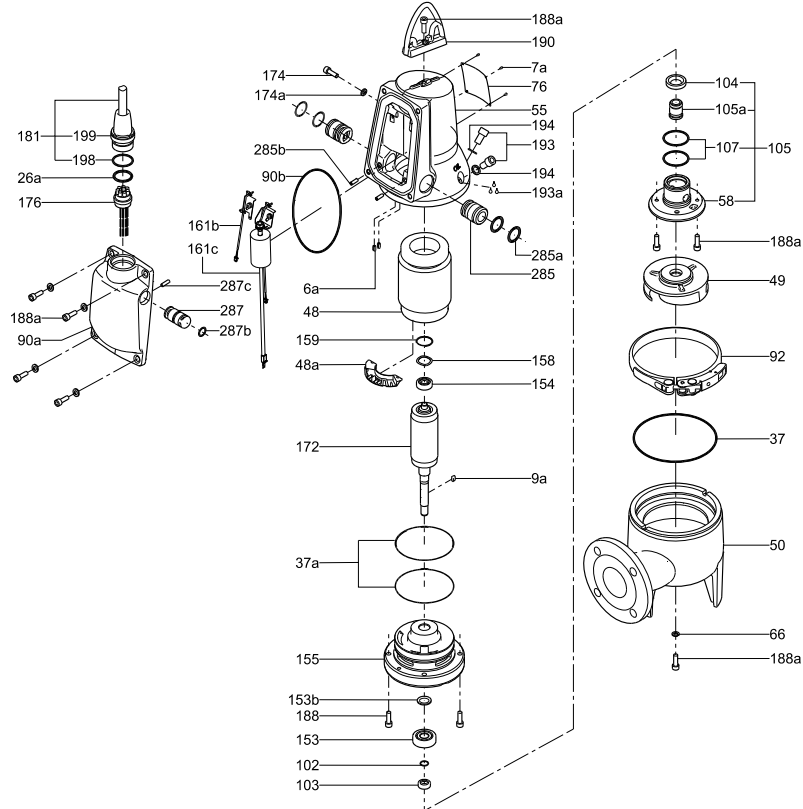

TM04 4800 2109