

P382X8XPRG102 (B10)

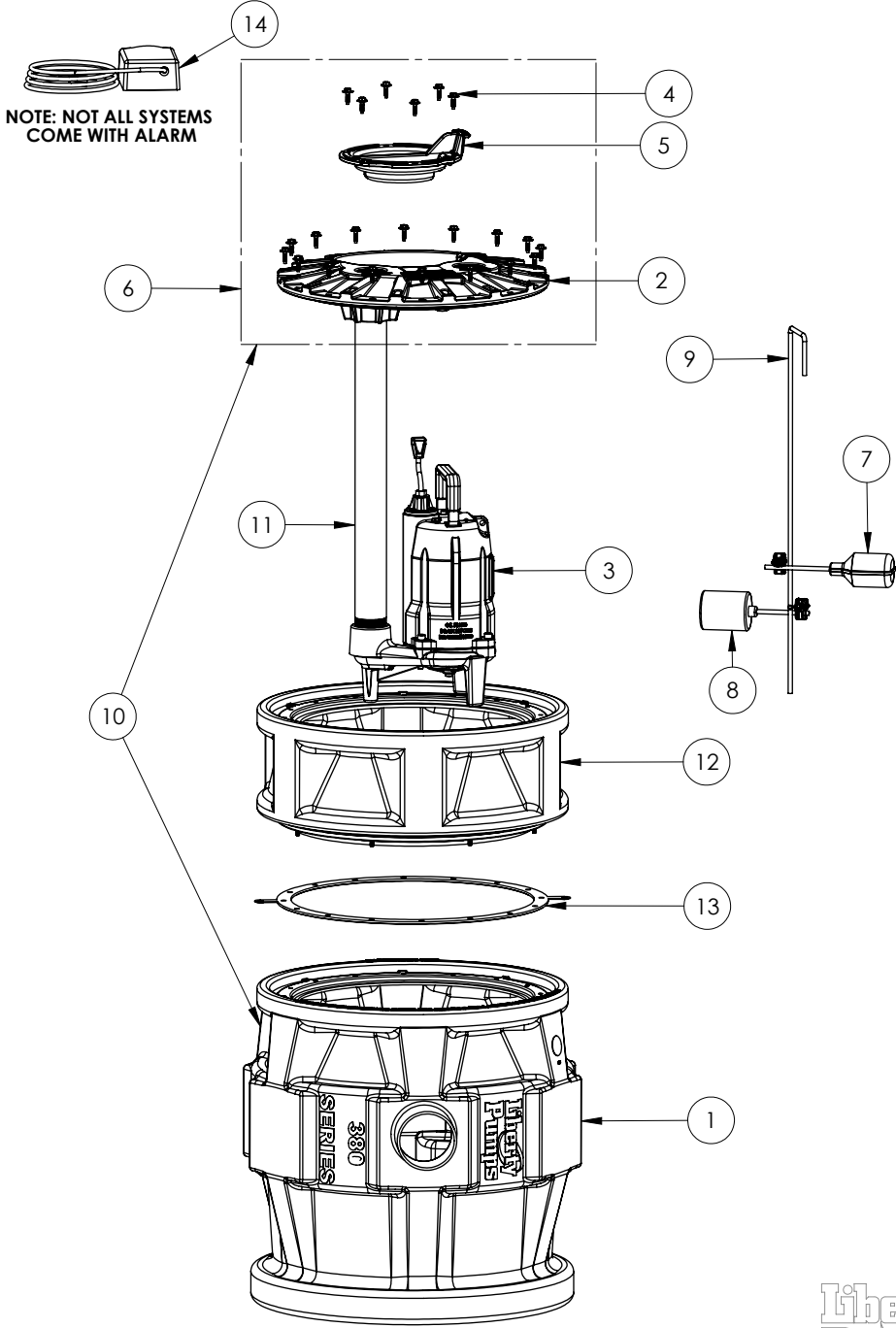

P382X8XPRG102 (B10)

#	PART #	DESCRIPTION	QTY	Note
1	K001133	380XL TANK 16 BOLTS	1	
2	50340B0	2X2 COVER, 16 BOLT	1	
3	SEE NOTE FOR PUMP MODEL #	LIBERTY PUMP	1	[1]
4	8155000	WASHER HEAD HEX SCREW	22	
5	K001233	INSPECTION COVER, INCLUDES MOUNTING SCREWS (6)	1	
6	K001127	2X2 COVER ASSEMBLY, 16 BOLT, PVC	1	
7	Pro Series Alarm switch (B10)	REPLACEMENT SWITCH BASED ON SYSTEM LABEL	1	[2]
8	SEE NOTE FOR PUMP SWITCH	PUMP SWITCH ONLY	1	[3]
9	K001394	EXTENSION QUICK TREE KIT, ROD AND CLAMPS ONLY	1	
10	K001137	P382XL TANK AND COVER	1	
11	40650D0	2" PVC SCH80 25.375" LONG	1	
12	X8	EXTENSION KIT, INCLUDES EXT BASIN,PIPE, BOLTS AND QUICK TREE SUPPORT	1	[4]
13	45990A0	GASKET MOLDED 20CVR SOFT	1	
14	SEE NOTE FOR ALARM	ALARM ONLY		[5]
15	K001054	61130A0 PUMP SWITCH, 10' 115V	1	
16	K001144	61130B0 PUMP SWITCH, 25' 115V	1	
17	K001134	FLOAT SWITCH, 20FT CORD, INCLUDES 1 SWITCH PER KIT	1	
18	K001415	60050D0 SWITCH, 10' PILOT DUTY PIGTAIL	1	

PART NOTES:

[1] - Part requires factory authorized service. Contact Liberty Pumps at 1-800-543-2550

****NOTE****

Select PROSERIES Pump below to show sewage pump assembly parts

ex: P382X8XPRG102/A2

PRG102

PRG102-2

[2] - ****NOTE****

ALARM SWITCH KITS

For /A2 Suffix of model number use Part No. K001134

For /A21 Suffix of model number use Part No. K001415

For /A2W Suffix of model number use Part No. K001134

[3] - Part requires factory authorized service. Contact Liberty Pumps at 1-800-543-2550

****NOTE****

Switch Kits:

for pump PRG101: K001054

for pump PRG101-2: K001144

P382X8XPRG102 (B10)

[4] - To view PROSERIES X8 EXTENSION KIT [click here](#)

[5] - ALARM PRO SERIES

FORA2 SUFFIX OF MODEL

NUMBER: USE PART NO 6225000

FORA2W SUFFIX OF MODEL

NUMBER: USE PART NO 6226000

FORA21 SUFFIX OF MODE

NUMBER: USE PART NO 6242000

Part requires factory authorized service. Contact Liberty Pumps at 1-800-543-2550