

LEH154M3-3E (B84)

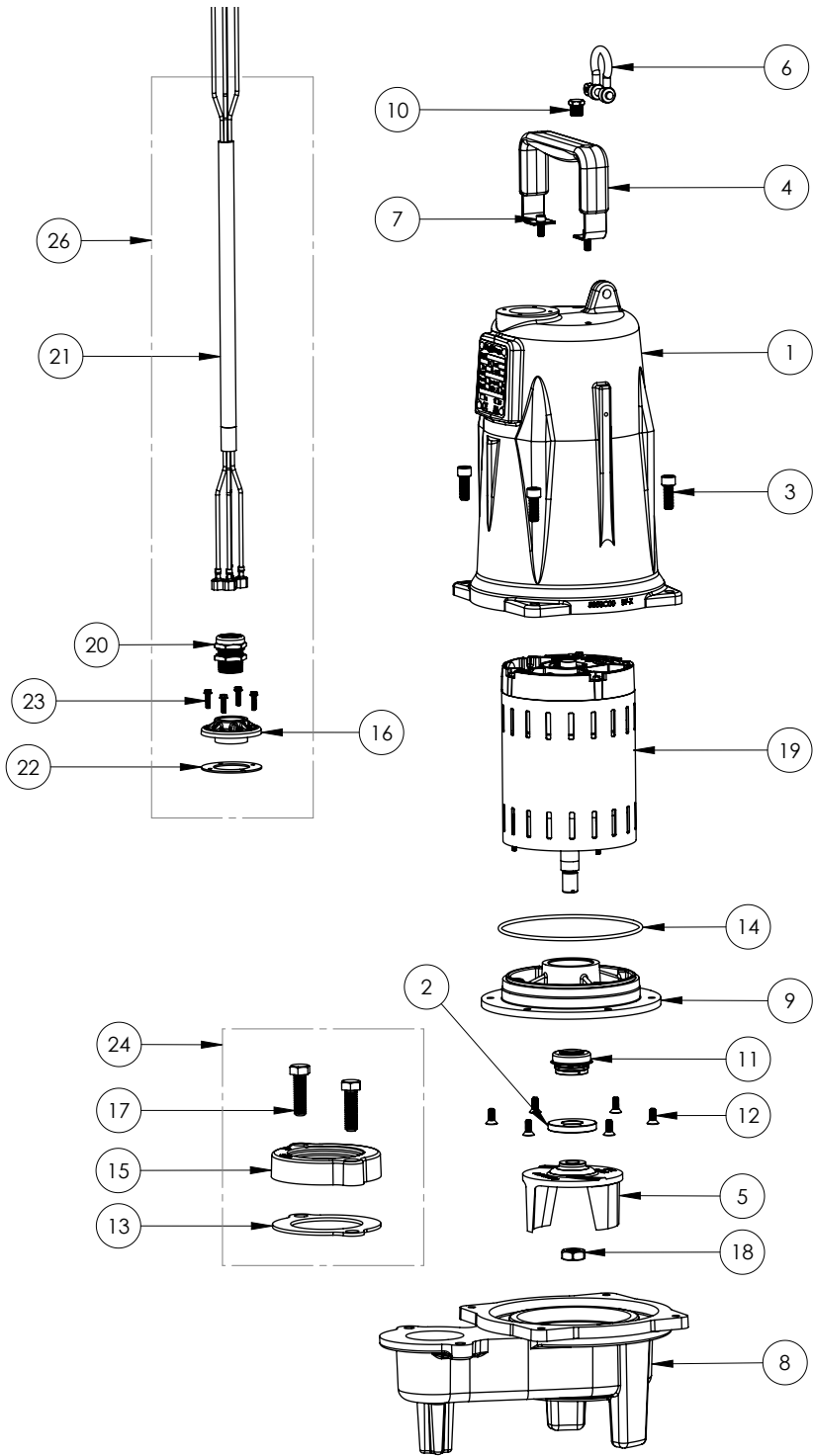

LEH154M3-3E

LEH154M3-3E (B84)

#	PART #	DESCRIPTION	QTY	Note
1	585000R	MOTOR COVER PAINTED	1	
2	5618000	DOUBLE LIP SEAL	1	[1]
3	5862000	BOLT, 3/8-16X1 SHCS SS	4	
4	5613000	HANDLE	1	
5	K001323	IMPELLER, CAST IRON, INCLUDES 5887000	1	
6	5611000	SHACKLE	1	
7	8103000	SCREW 1/4-20x5/8" HX SKT SSSCREW 1/4-20X5/8 HX SKT SS	2	
8	58730AR	LEH150 SERIES VOLUTE	1	
9	5851000	MOTOR PLATE	1	
10	50710A0	PIPE PLUG, 1/4" HEX HD BRASS NPTF	1	
11	5633000	3/4" UNITIZED SHAFT SEALSEAL	1	[1]
12	8018000	1/4-20 x 5/8 SLOTTED FLAT HEAD BOLTBOLT 1/4-20x5/8 FL HD SS	6	
13	5129000	FLANGE GASKET, FITS 2" OR 3"FLANGE GASKET	1	
14	5617000	O-RINGORING #2-253 BUNA	1	
15	512200R	3" DISCHARGE FLANGE	1	
16	57890AR	PAINTED 3/4 NPT, CE CORD PLATE	1	
17	8037000	1/2-13 x 1-3/4 STAINLESS STEEL BOLTBOLT, 1/2-13X1-3/4 S.S.	2	
18	5887000	NUT, JAM, 5/8-18 HEX S.S.	1	
19	5884000	MOTOR 2HP 230-460V 3PH LEHMOTOR, 2HP 230V 1PH 2 POLE LEH	1	[1]
20	5790000	STRAIN RELIEF, 3/4 NPT STAINLESS, IEC	1	
21	5794000	POWER CORD, IEC COMPLIANT 10M	1	
22	5060000	CORD PLATE GASKETCORDPLATE GASKET	1	
23	8064000	#8-32 x 5/8 HEX WASHER HEAD SCREWSREW 8-32x5/8 IND HWD.SS	4	
24	K001222	3" DISCHARGE KIT	1	
26	K001419	IEC 3PH 10M CORD KIT	1	

PART NOTES:

[1] - Part requires factory authorized service. Contact Liberty Pumps at 1-800-543-2550