

LEH152M3 (B54)

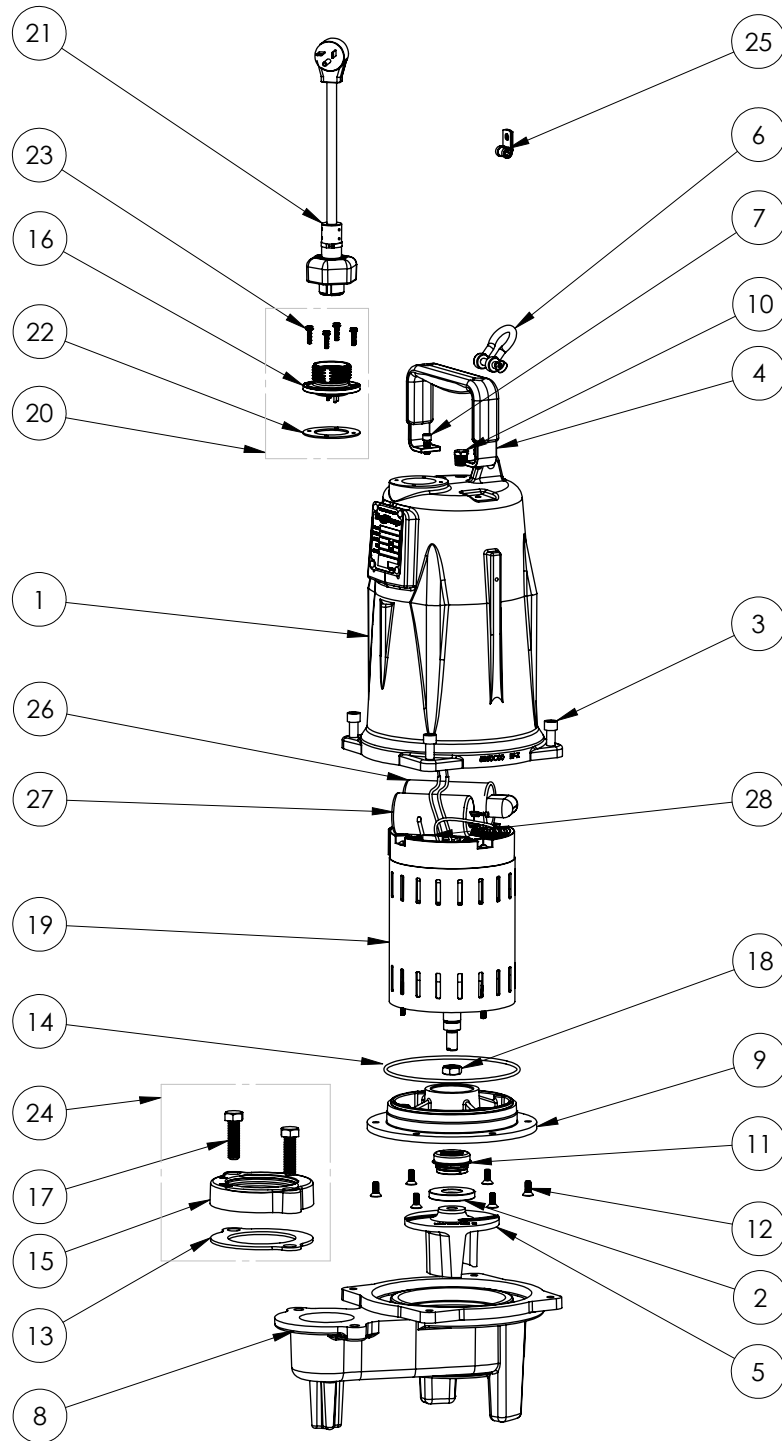

LEH152M3**LEH152M3 (B54)**

#	PART #	DESCRIPTION	QTY	Note
1	5850000	MOTOR COVER	1	
2	5618000	DOUBLE LIP SEAL	1	[1]
3	5862000	BOLT, 3/8-16X1 SHCS SS	4	
4	5613000	HANDLE	1	
5	K001223	IMPELLER, CAST IRON, INCLUDES 8046000	1	
6	5611000	SHACKLE	1	
7	8103000	SCREW 1/4-20x5/8" HX SKT SS	2	
8	58730AR	LEH150 SERIES VOLUTE	1	
9	5851000	MOTOR PLATE	1	
10	5071000	BRASS OIL PLUG	1	
11	5633000	3/4" UNITIZED SHAFT SEAL	1	[1]
12	8018000	1/4-20 x 5/8 SLOTTED FLAT HEAD BOLT	6	
13	5129000	FLANGE GASKET, FITS 2" OR 3"	1	
14	5617000	O-RING	1	
15	K001222	3" DISCHARGE KIT	1	
16	K001216	5619000, CORDPLATE	1	
17	8037000	1/2-13 x 1-3/4 STAINLESS STEEL BOLT	2	
18	8046000	1/2-20 HEX STAINLESS STEEL JAM NUT	1	
19	5883000	MOTOR 2HP 230V 1PH 2 POLE LEH	1	[1]
20	K001216	5619000, CORDPLATE	1	
21	K001140	POWER CORD	1	
22	5060000	CORD PLATE GASKET	1	
23	8064000	#8-32 x 5/8 HEX WASHER HEAD SCREW	4	
24	K001222	3" DISCHARGE KIT	1	
25	5630000	CABLE CLAMP S.S.	1	
26	K001228	RUN CAPACITOR	1	
27	K001227	START CAPACITOR	1	
28	K001229	START SWITCH	1	

PART NOTES:

[1] - Part requires factory authorized service. Contact Liberty Pumps at 1-800-543-2550