

LE52M-2 (B20)

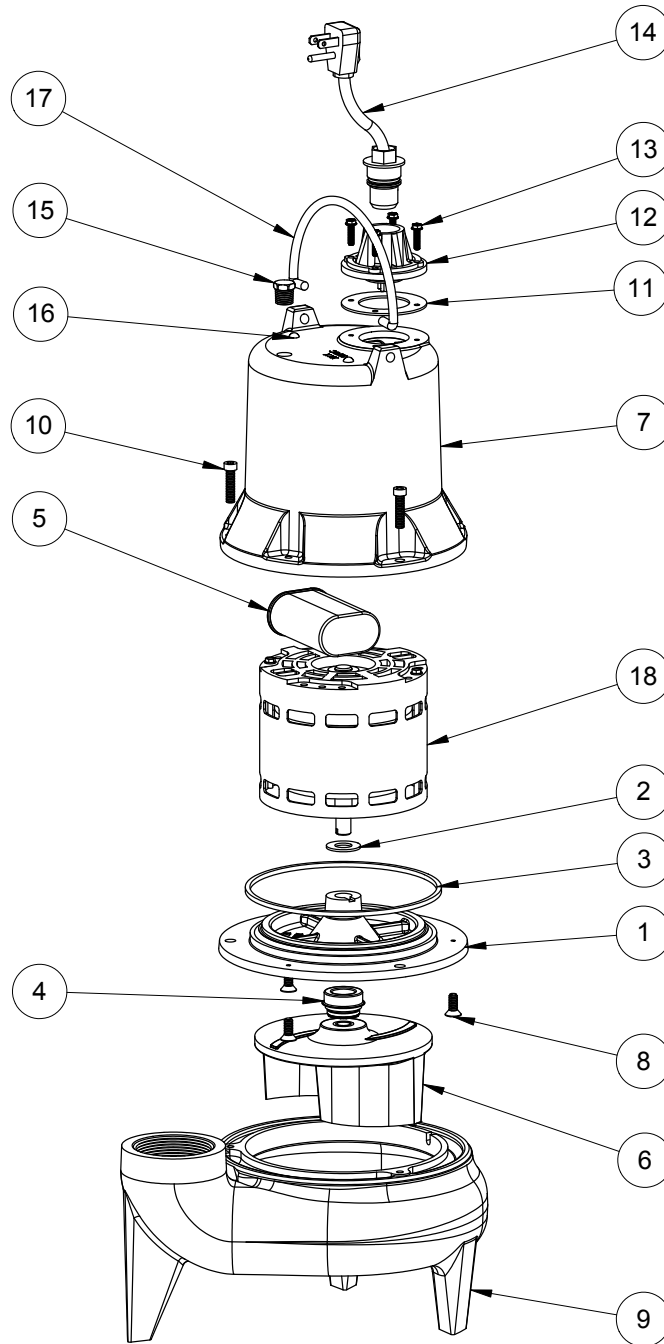

LE52M-2**LE52M-2 (B20)**

#	PART #	DESCRIPTION	QTY	Note
1	5052000	MOTOR SUPPORT PLATE	1	
2	5395000	THRUST WASHER	1	
3	5066000	SEALRING, MOTOR COVER, #254S	1	[1]
4	5098000	1/2 INCH UNITIZED SEAL	1	
5	51930C0	CAPACITOR	1	
6	K001039	IMPELLER	1	
7	527800R	MOTOR CAP	1	
8	8018000	1/4-20 x 5/8 SLOTTED FLAT HEAD BOLT	3	
9	545100R	HOUSING, VOLUTE	1	
10	8091000	1/4-20 x 1 HEX SOCKET HEAD BOLT	3	
11	5060000	CORD PLATE GASKET	1	
12	5014000	CORD PLATE	1	
13	8064000	#8-32 x 5/8 HEX WASHER HEAD SCREW	4	
14	K001059	POWER CORD, 230V, 25 FOOT CORD	1	
15	5071000	BRASS OIL PLUG	1	
16	8033000	#8 x 1/4 STAINLESS STEEL SCREW	2	
17	K001095	STAINLESS STEEL HANDLE	1	
18	5195000	MOTOR .5HP PSC 230V	1	

PART NOTES:

[1] - Part requires factory authorized service. Contact Liberty Pumps at 1-800-543-2550