

LE104M3-2 (B72)

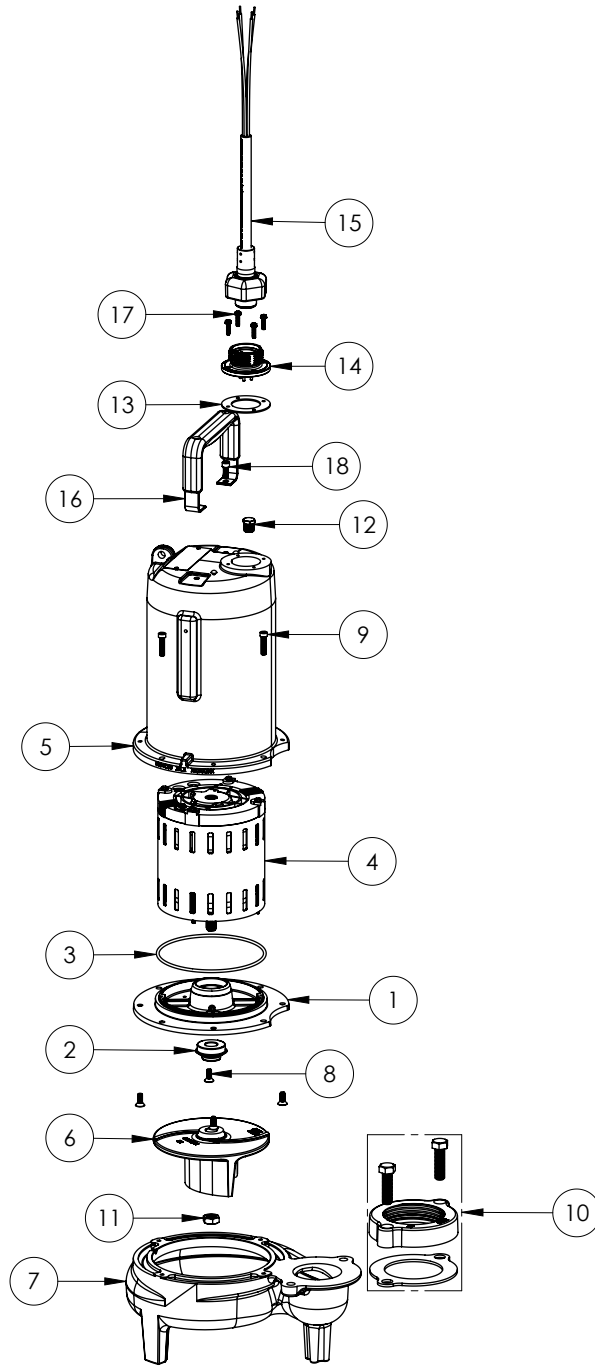

LE104M3-2**LE104M3-2 (B72)**

#	PART #	DESCRIPTION	QTY	Note
1	53260BR	MOTOR SUPPORT PLATE	1	
2	5120000	5/8 INCH UNITIZED SHAFT SEAL	1	[1]
3	5617000	O-RING	1	
4	5333000	MOTOR	1	[1]
5	531400R	MOTOR COVER	1	
6	K001486	5131000 IMPELLER KIT, INCLUDES 1/2" JAM NUT	1	
7	531500R	VOLUTE HOUSING	1	
8	8018000	1/4-20 x 5/8 SLOTTED FLAT HEAD BOLT	4	
9	8091000	1/4-20 x 1 HEX SOCKET HEAD BOLT	4	
10	K001222	3" DISCHARGE KIT	1	
11	8046000	1/2-20 HEX STAINLESS STEEL JAM NUT	1	
12	5071000	BRASS OIL PLUG	1	
13	5060000	CORD PLATE GASKET	1	
14	5629000	GRINDER CORDPLATE	1	
15	K001357	POWER CORD, 25FT	1	
16	3411200	HANDLE	1	
17	8064000	#8-32 x 5/8 HEX WASHER HEAD SCREW	4	
18	8103000	SCREW 1/4-20x5/8" HX SKT SS	2	

PART NOTES:

[1] - Part requires factory authorized service. Contact Liberty Pumps at 1-800-543-2550