

LE103M2-2 (B75)

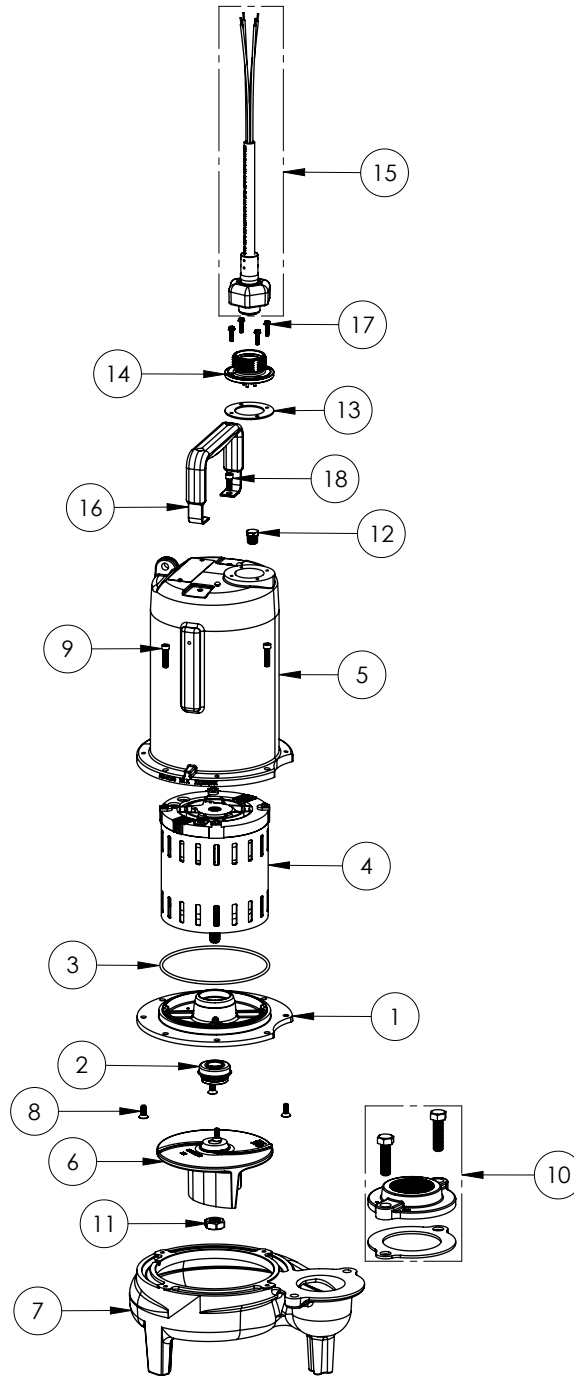

LE103M2-2**LE103M2-2 (B75)**

#	PART #	DESCRIPTION	QTY	Note
1	537600R	MOTOR PLATE LE100 3PHASE	1	
2	5633000	3/4" UNITIZED SHAFT SEAL	1	[1]
3	5617000	O-RING	1	
4	5333000	MOTOR	1	[1]
5	531400R	MOTOR COVER	1	
6	K001487	51310A0 IMPELLER KIT, INCLUDES 5/8" JAM NUT	1	
7	531500R	VOLUTE HOUSING	1	
8	8018000	1/4-20 x 5/8 SLOTTED FLAT HEAD BOLT	4	
9	8091000	1/4-20 x 1 HEX SOCKET HEAD BOLT	4	
10	K001221	2" DISCHARGE KIT	1	
11	5887000	NUT, JAM, 5/8-18 HEX S.S.	1	
12	5071000	BRASS OIL PLUG	1	
13	5060000	CORD PLATE GASKET	1	
14	5629000	GRINDER CORDPLATE	1	
15	K001357	POWER CORD, 25FT	1	
16	3411200	HANDLE	1	
17	8064000	#8-32 x 5/8 HEX WASHER HEAD SCREW	4	
18	8103000	SCREW 1/4-20x5/8" HX SKT SS	2	

PART NOTES:

[1] - Part requires factory authorized service. Contact Liberty Pumps at 1-800-543-2550