

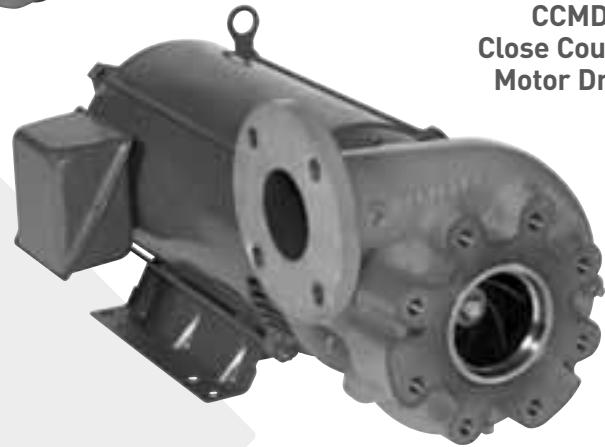

FM
Frame Mount

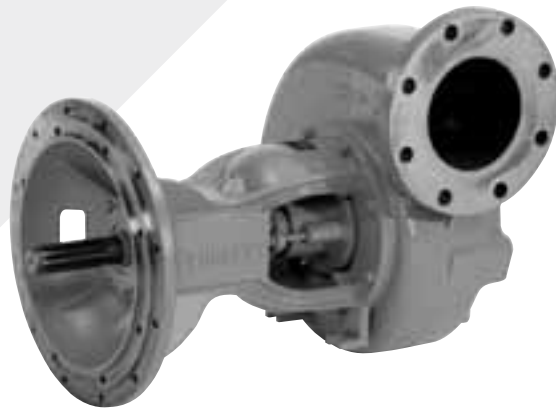

CCMD
Close Coupled
Motor Drive



Engine Drive
SAE

BERKELEY[®] TYPE B CENTRIFUGAL PUMPS PUMP PERFORMANCE

PUMP MODEL NOMENCLATURE

NAME PLATE EXAMPLE:

B 4 G P B H S

- B** – TYPE OF CONSTRUCTION
B = "Back Pull-Out" Design
- 4** – DISCHARGE SIZE (Inches)
NOMINAL IMPELLER DIAMETER (Inches)
3" = A 7" = W 11" = F 15" = EX 18" = EY
4" = M 8" = Y 12" = G 15.5" = XT 19" = EZ
5" = X 9" = Z 13" = J 16" = ET 20" = EE
6" = T 10" = E 14" = N 17" = EW
- P** – TYPE OF DRIVE
P = Electric Motor – Pump Attached Directly to Motor Frame
Q = Engine Drive – Pump Attached Directly to Engine Frame
R = Frame Mounted Belt or Flexible Coupling Drive
RM = Special Duty Mounting Frame
- B** – SPECIAL FEATURES (Optional)
B = Hydraulically Balanced Impeller Design
K = Self-Priming
- H** – RELATIVE CAPACITY OF IMPELLER
LL = Very Low
L = Low
M = Medium (Often Omitted)
H = High
HH = Very High
- 2** – NUMBER OF STAGES (Optional)
(Single stages not indicated)
- S** – SHAFT SEAL (Optional)
S = Mechanical Seal (Packed Stuffing Box is not indicated)
- 10** – HORSEPOWER OF MOTOR OR ENGINE (Optional)
(Normally indicated on Engine Driven Pumps only)

The model configurations above illustrate the complete range of closed coupled product identification numbers.

PUMP SIZE EXAMPLE:

4" x 6" x 13" B H

- 4"** – DISCHARGE SIZE (Inches)
- 6"** – SUCTION SIZE (Inches)
NOMINAL IMPELLER DIAMETER (Inches)
3" = A 7" = W 11" = F 15" = EX 18" = EY
4" = M 8" = Y 12" = G 15.5" = XT 19" = EZ
5" = X 9" = Z 13" = J 16" = ET 20" = EE
6" = T 10" = E 14" = N 17" = EW
- B** – SPECIAL FEATURES (Optional)
B = Hydraulically Balanced Impeller Design
- H** – RELATIVE CAPACITY OF IMPELLER
LL = Very Low
L = Low
M = Medium (Often Omitted)
H = High
HH = Very High

Berkeley Type B Hydraulic Performance (by product group)

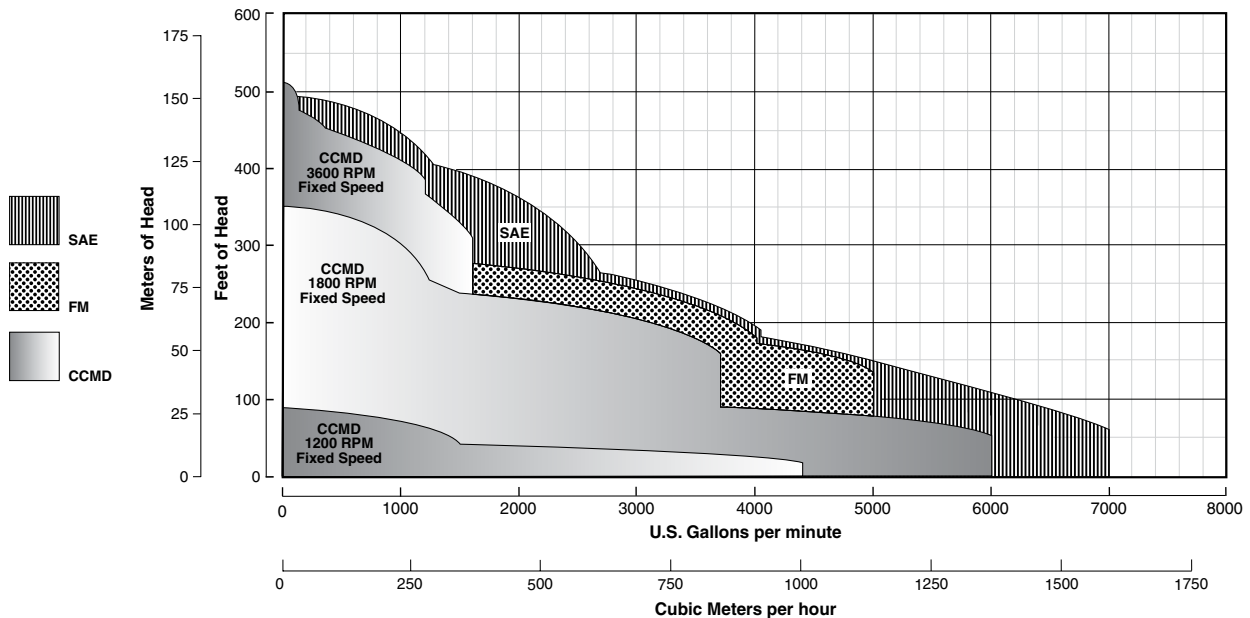

TABLE OF CONTENTS

MODEL	SERIES	PUMP SIZE	Page No.	
B1MRS	M	1 x 1-1/4 x 4	4	
B1-1/2M_S		1-1/2 x 2 x 4	5-6	
B1XRS	X	1 x 1-1/4 x 4	7	
B1XRMS		1 x 1-1/4 x 4	8	
B1-1/2T_L	T	1-1/2 x 2 x 6L	9-10	
B1-1/2T_M		1-1/2 x 2 x 6M	11-12	
B2T_M		2 x 2-1/2 x 6M	13-14	
B2-1/2T_M		2-1/2 x 3 x 6M	15-17	
B3T_M		3 x 4 x 6M	18-20	
B3T_H		3 x 4 x 6H	21-23	
B3T_HH		3 x 4 x 6HH	24-25	
B1W	W	1 x 1-1/2 x 7	26-27	
B5W		5 x 6 x 7	28-29	
B1-1/2Z_L	Z	1-1/2 x 2 x 9L	30-31	
B1-1/2Z_HS		1-1/2 x 2 x 9H	32	
B1-1/2Z_HS		1-1/2 x 2 x 9H	33	
B2Z_L		2 x 2-1/2 x 9L	34-35	
B2Z_M		2 x 2-1/2 x 9M	36	
B2Z_H		2 x 2-1/2 x 9H	37-38	
B2-1/2Z_L		2-1/2 x 3 x 9L	39-40	
B2-1/2Z_M		2-1/2 x 3 x 9M	41-42	
B3Z_L		3 x 4 x 9L	43-44	
B3Z_M		3 x 4 x 9M	45-46	
B3Z_BH		3 x 4 x 9BH	47-48	
B4Z_H		4 x 5 x 9BH	49-50	
B5Z_H		5 x 6 x 9BH	51-52	
B6Z_L		6 x 8 x 9L	53-54	
B6Z_M-CCW		6 x 8 x 9M-CCW	55-56	
B6Z_H	6 x 8 x 9H	57-58		
B6Z_BHH	6 x 8 x 9BH	59-60		
B1-1/2E_L	E	1-1/2 x 2 x 10L	61-62	
B2E_BL		2 x 3 x 10BL	63-64	
B2E_L		2 x 3 x 10L	65	
B2E_H		2 x 3 x 10H	66	
B2E_BH		2 x 3 x 10BH	67	
B2E_BHH		2 x 3 x 10BHH	68-69	
B2E_HH		2 x 3 x 10HH	70	
B3E_BL		3 x 4 x 10BL	71-72	
B3E_M		3 x 4 x 10M	73-74	
B4E_BM		4 x 5 x 10BM	75-76	
B4E_M		4 x 5 x 10M	77-78	
B5E_BM		5 x 6 x 10BM	79-80	
B5E_H		5 x 6 x 10H	81-82	
B5E_BH		5 x 6 x 10BH	83	
B4G_BH		4 x 5 x 12BH	84-85	
B8G_BM	8 x 10 x 12BM	68-88		
B10G_BM - 4 pole	10 x 12 x 12BM	89		
B10G_BM - 6 pole	10 x 12 x 12BM	90-91		
B2-1/2J_BL	J	2-1/2 x 4 x 13BL	92	
B2-1/2J_BM		2-1/2 x 4 x 13BM	93-94	
B3J_BL		3 x 4 x 13BL	95-96	
B3J_BM		3 x 4 x 13BM	97-98	
B4J_BH		4 x 5 x 13BH	99-100	
B4J_BHH		4 x 6 x 13BHH	101-102	
B6J_BL		6 x 8 x 13BL	103-104	
B6J_BM		6 x 8 x 13BM	105-107	
B6J_BM-CW		6 x 8 x 13BM-CW	108	
B6J_BH		6 x 8 x 13BH	109-110	
B8J_BH		8x10x13 BH	111-112	
B10J_BH		10x12x13 BH	113-114	
B4EX_BL		EX	4 x 5 x 15BL	115-116
B5EX_BH			5 x 6 x 15BH	117-118
B6EX_BL			6 x 8 x 15BL	119-120
B6EX_BM	6 x 8 x 15BM		121	
B6EX_BH	6 x 8 x 15BH		122-123	
B6XT_BH-15.5"	6 x 8 x 15.5BH		124	
B6XT_BH-14"	6 x 8 x 14BH		125	
B4EY_BM	EY	4 x 5 x 18BM	126-127	
B4EY_BH		4 x 5 x 18BH	128-129	
PRODUCT INDEX			130-131	

Pump Size: 1 x 1-1/4 x 4

Model: B1MRS

Curve No. 7327

Type	CCMD	FM CPLG	FM BELT	SAE	Hydraulic	AC Engine
Model		B1MRS	B1MRS			
RPM		2800-4500	2800-4500			

Dia. 4.50"

Nominal RPM: **VARIOUS**
 Based on Fresh Water @ 68°F (20°C)
 Maximum Working Pressure: 266 PSI (18 BAR)

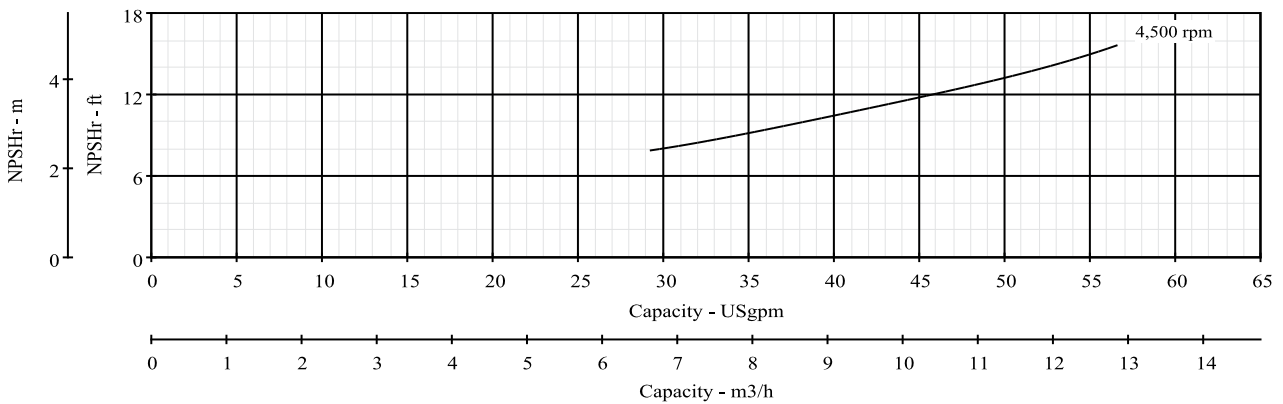
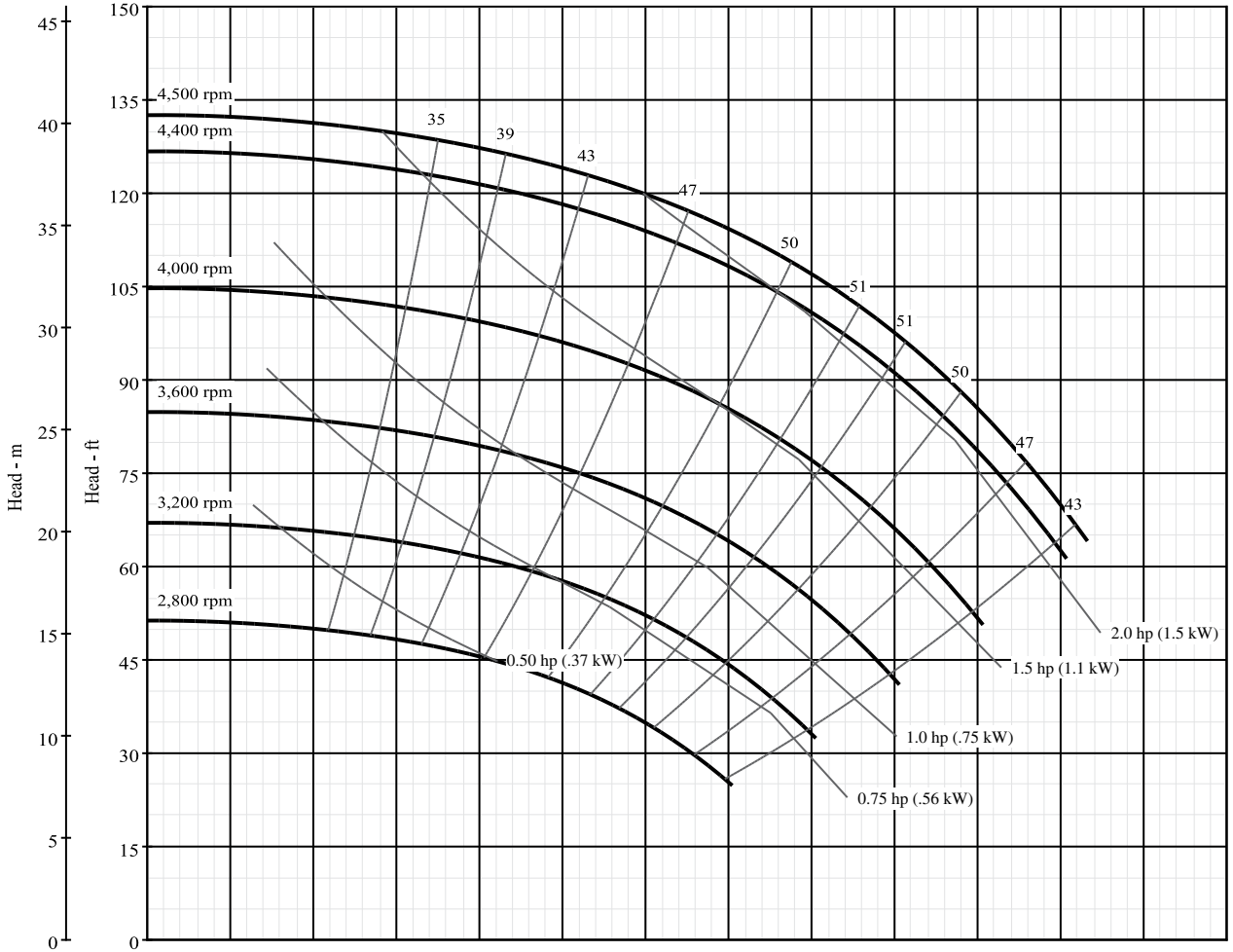

*NPSH data shown is at maximum speed

Pump Size: 1-1/2 x 2 x 4

Model: B1-1/2MRS

Curve No. 2676

Type	CCMD	FM CPLG	FM BELT	SAE	Hydraulic	AC Engine
Model		B1-1/2MRS	B1-1/2MRS			

Dia. 3.88"

Nominal RPM: **3600**
 Based on Fresh Water @ 68°F (20°C)
 Maximum Working Pressure: 266 PSI (18 BAR)

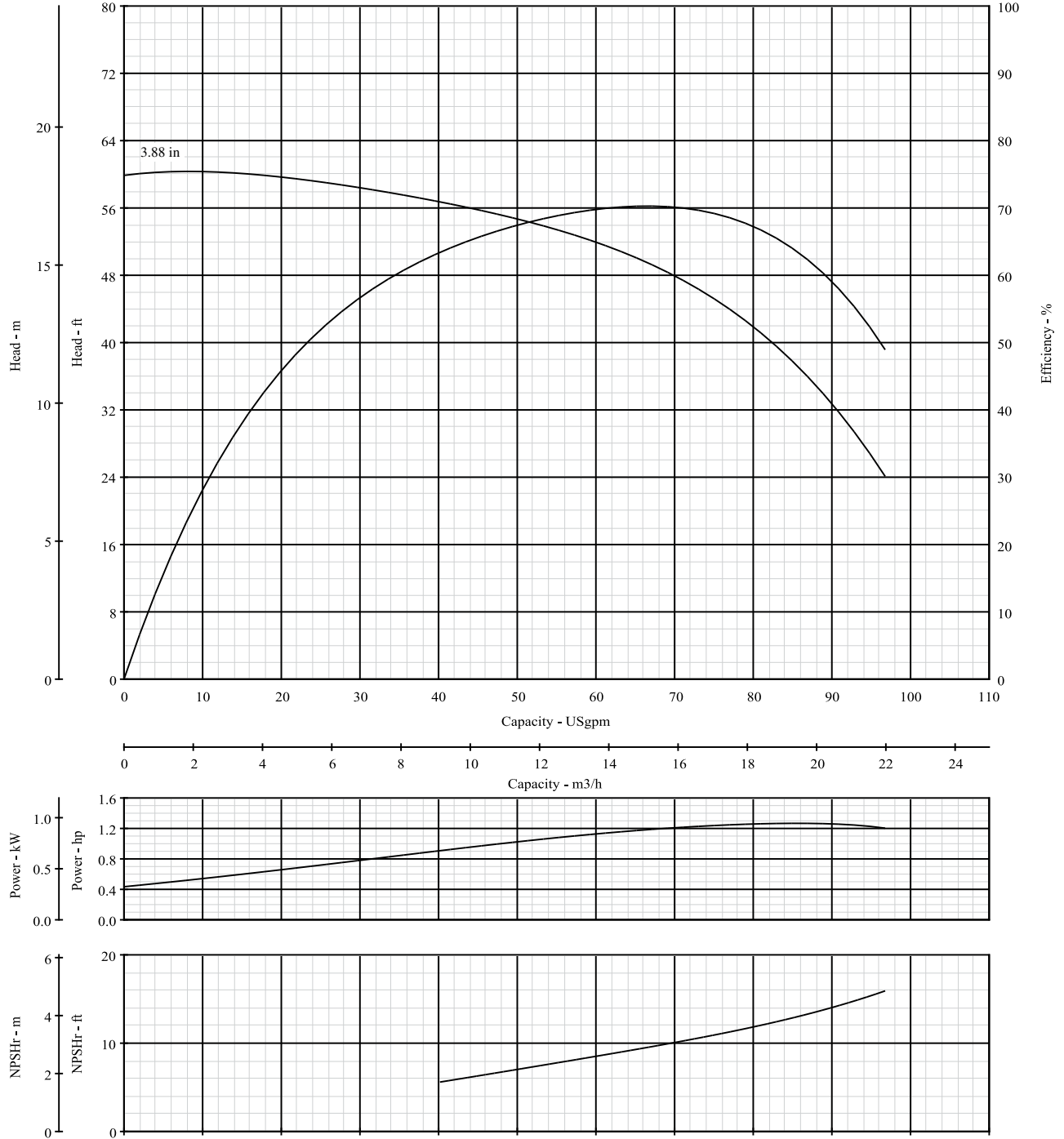

Pump Size: 1-1/2 x 2 x 4

Model: B1-1/2MRS

Curve No. 2676

Type	CCMD	FM CPLG	FM BELT	SAE	Hydraulic	AC Engine
Model		B1-1/2MRS	B1-1/2MRS			
RPM		2800-4900	2800-4900			

Dia. 3.88"

Nominal RPM: **VARIOUS**
 Based on Fresh Water @ 68°F (20°C)
 Maximum Working Pressure: 266 PSI (18 BAR)

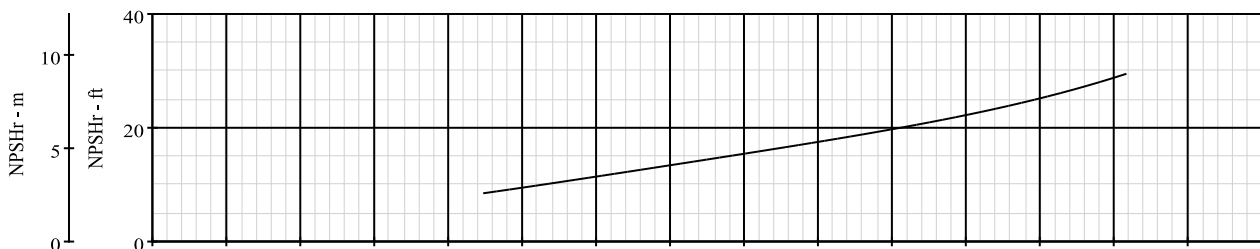
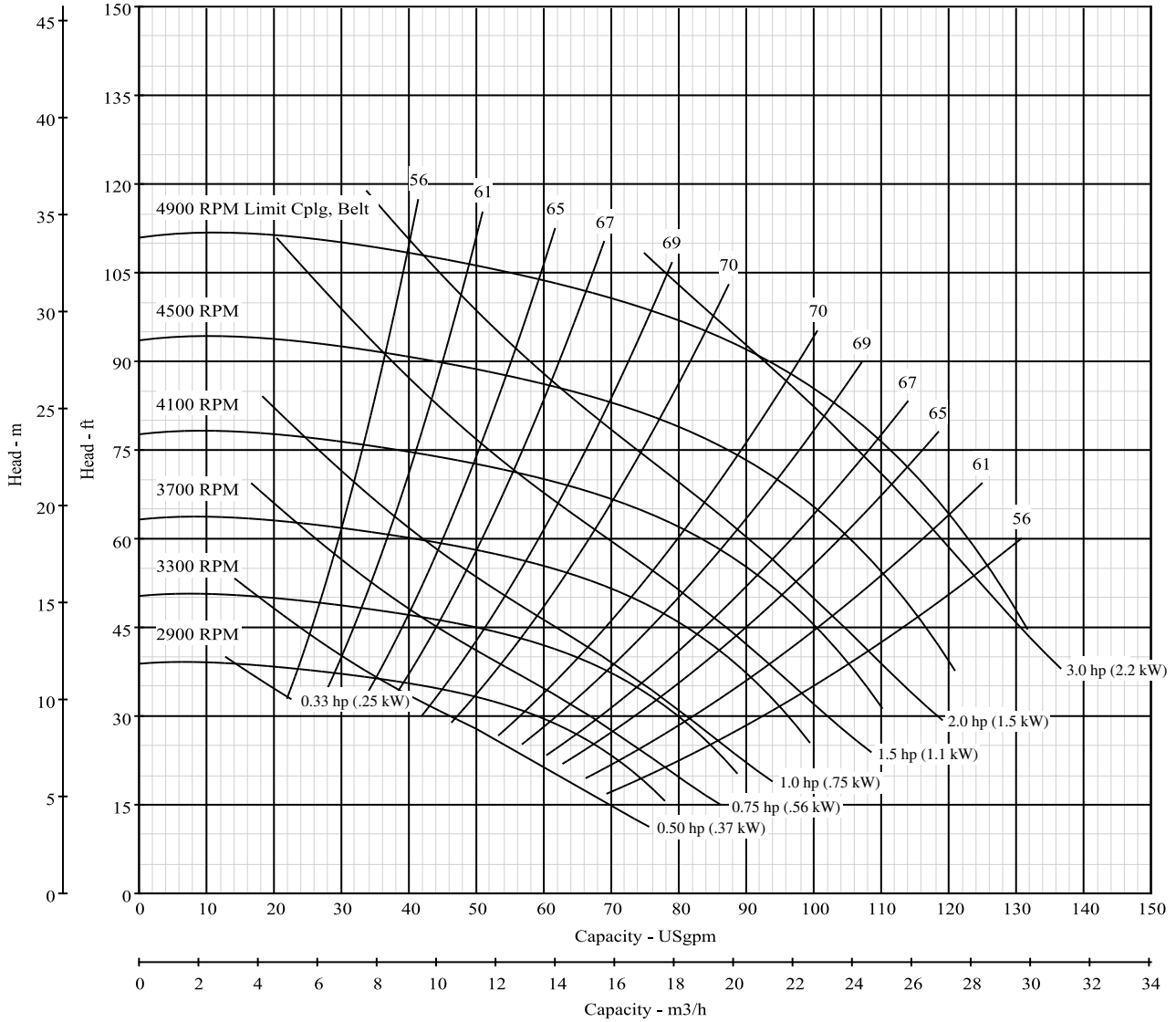

*NPSH data shown is at maximum speed

Pump Size: 1 x 1-1/4 x 5

Model: B1XRS

Curve No. 7328

Type	CCMD	FM CPLG	FM BELT	SAE	Hydraulic	AC Engine
Model		B1XRS	B1XRS			
RPM		2000-3600	2000-3600			

Dia. 5.31"

Nominal RPM: **VARIOUS**
 Based on Fresh Water @ 68°F (20°C)
 Maximum Working Pressure: 266 PSI (18 BAR)

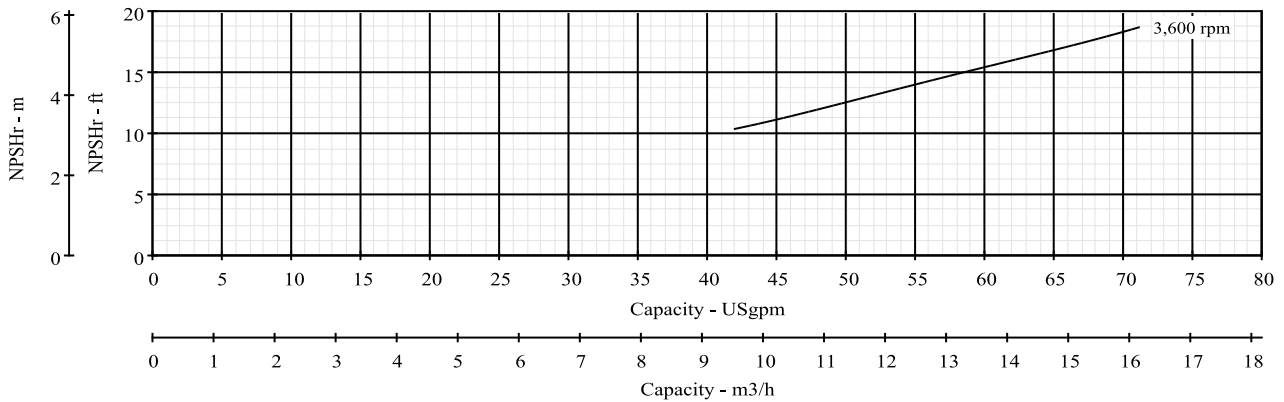
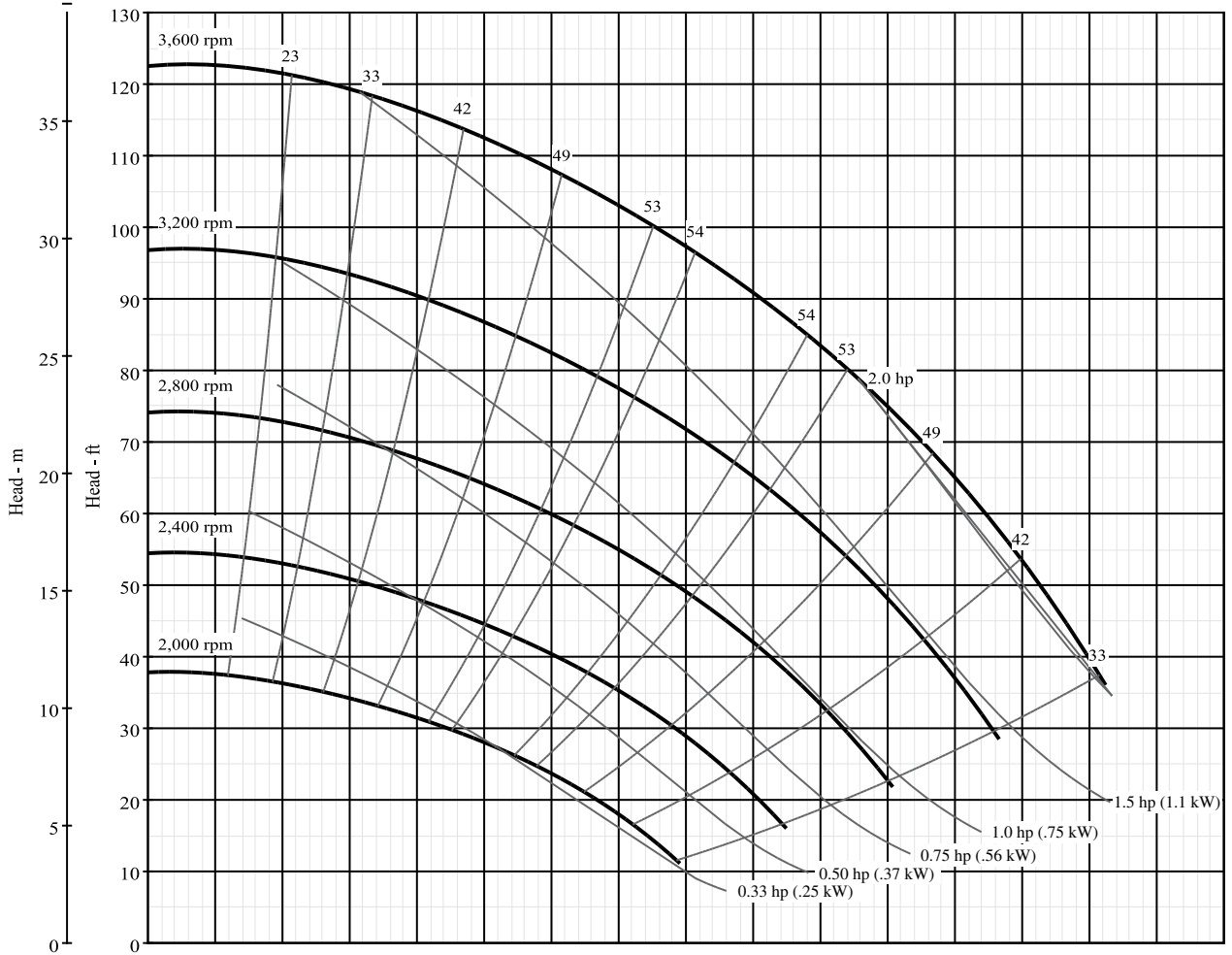

*NPSH data shown is at maximum speed

Pump Size: 1 x 1-1/4 x 5

Model: B1XMRS

Curve No. 7902

Type	CCMD	FM CPLG	FM BELT	SAE	Hydraulic	AC Engine
Model		B1XMRS	B1XMRS			
RPM		2400-3700	2400-3700			

Dia. 5.31"

Nominal RPM: **VARIOUS**
 Based on Fresh Water @ 68°F (20°C)
 Maximum Working Pressure: 266 PSI (18 BAR)

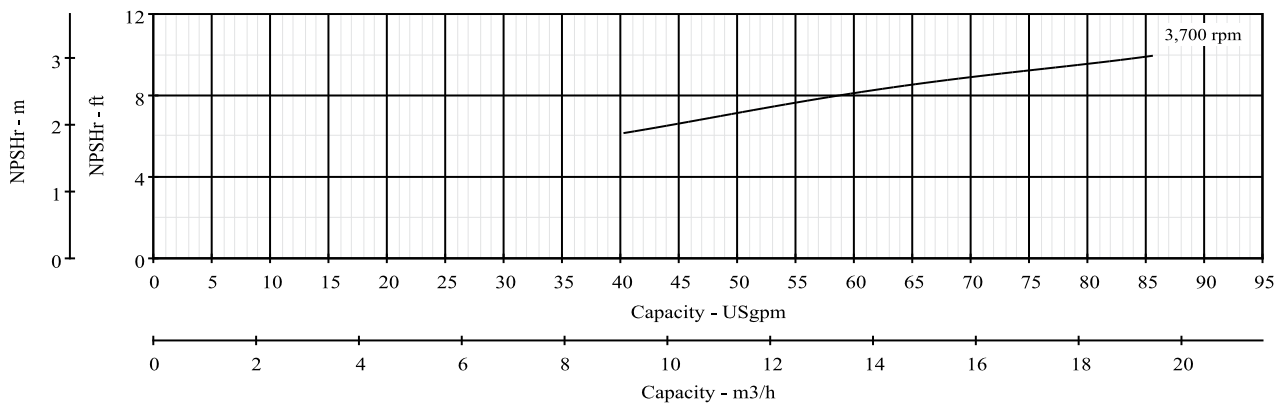
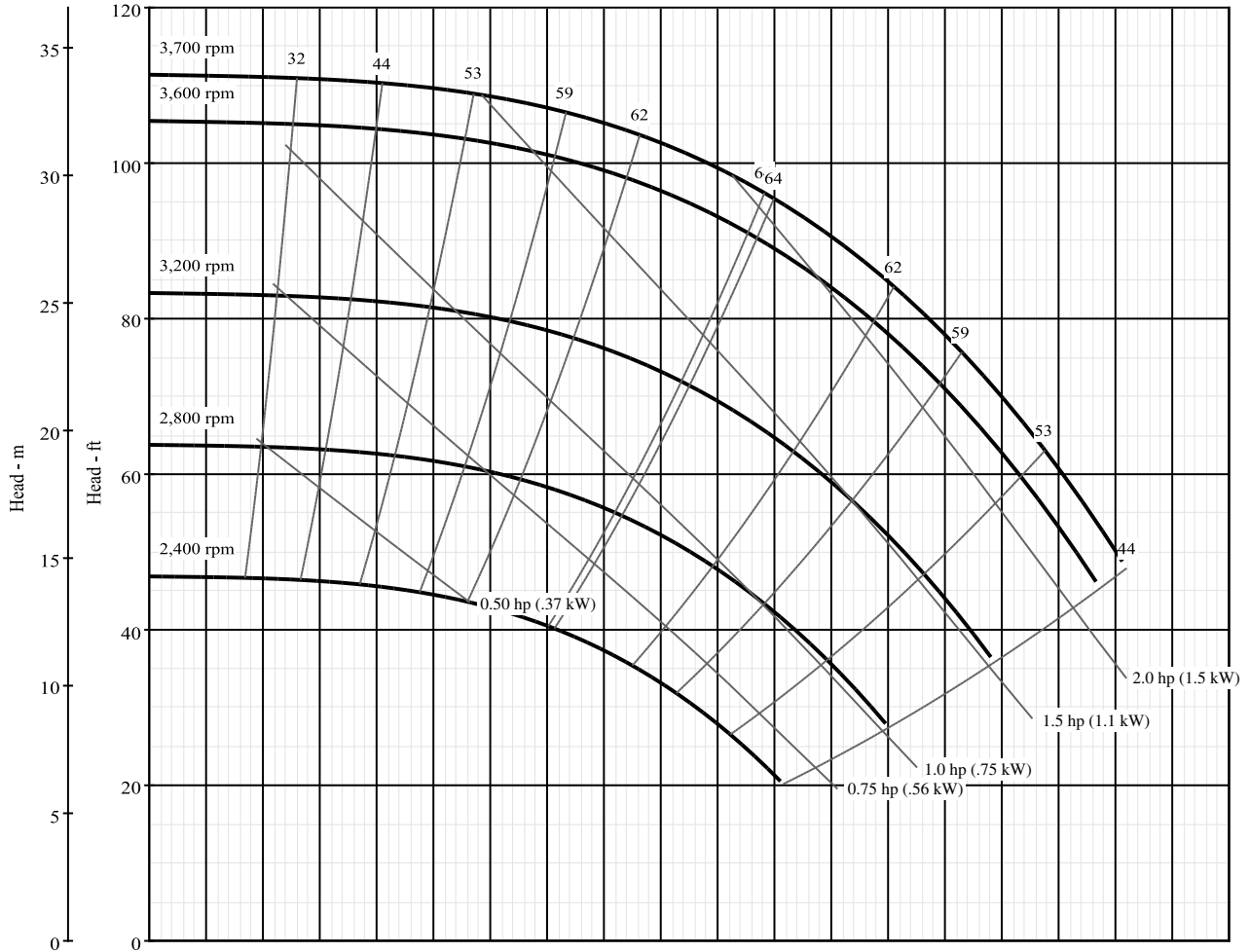

*NPSH data shown is at maximum speed

Pump Size: 1-1/2 x 2 x 6 L

Model: B1-1/2T_L

Curve No. 5035

Type	CCMD	FM CPLG	FM BELT	SAE	Hydraulic	AC Engine
Model	B1-1/2TPL	B1-1/2TRLS	B1-1/2TRLS			

Nominal RPM: **3450**
 Based on Fresh Water @ **68°F (20°C)**
 Maximum Working Pressure: **266 PSI (18 BAR)**

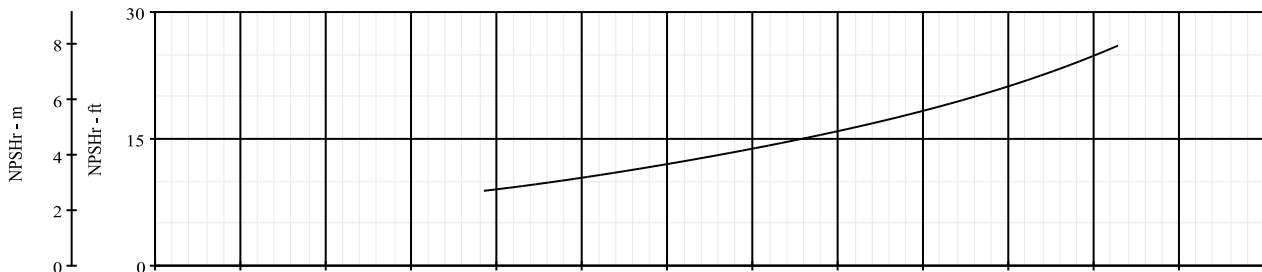
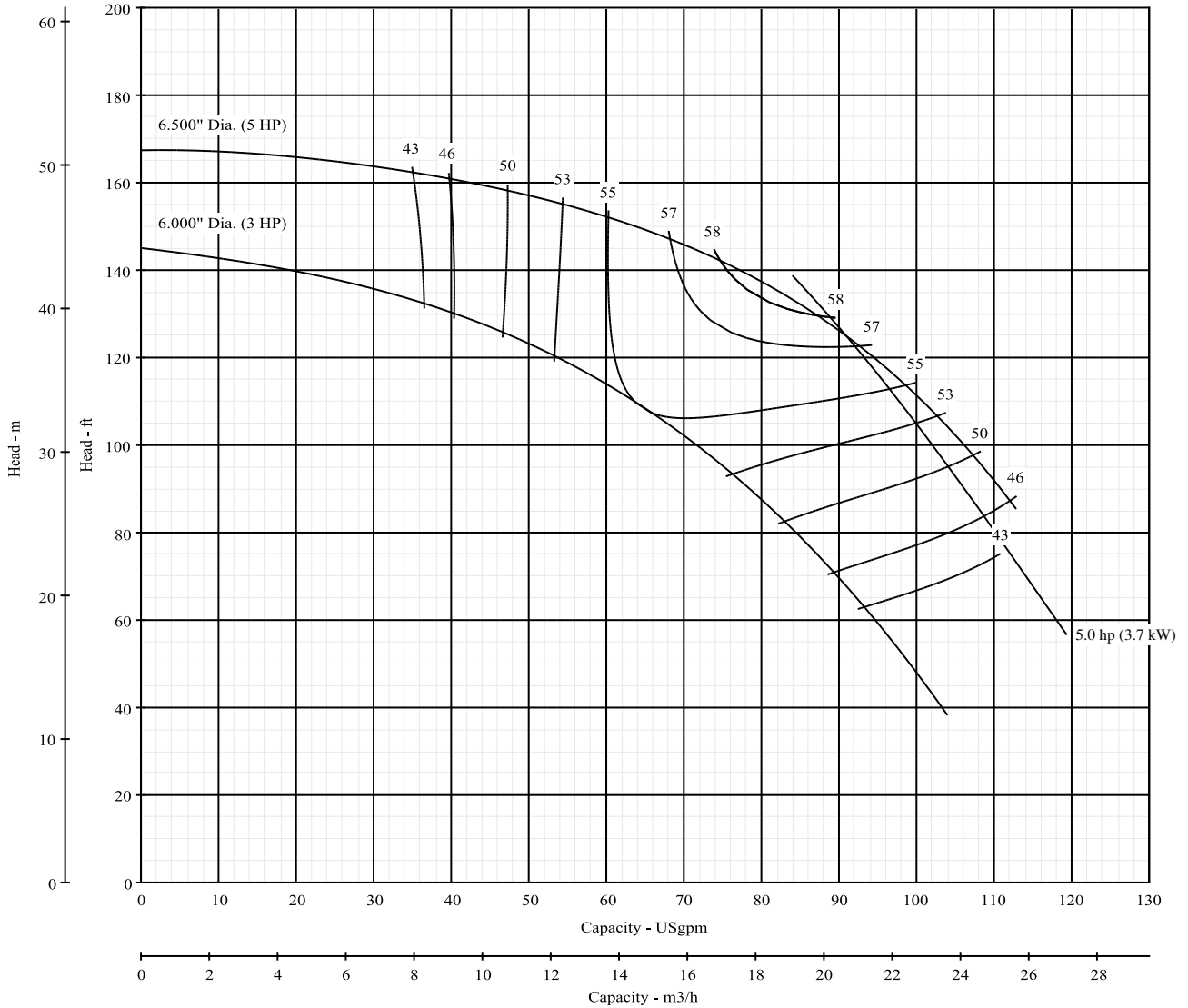

Pump Size: 1-1/2 x 2 x 6 L

Model: B1-1/2T_L

Curve No. 5035

Type	CCMD	FM CPLG	FM BELT	SAE	Hydraulic	AC Engine
Model	B1-1/2TPL	B1-1/2TRLS	B-1-1/2TRLS			
RPM	1801-3600	1800-3500	1800-3500			

Dia. 6.50"

Nominal RPM: **VARIOUS**
 Based on Fresh Water @ 68°F (20°C)
 Maximum Working Pressure: 266 PSI (18 BAR)

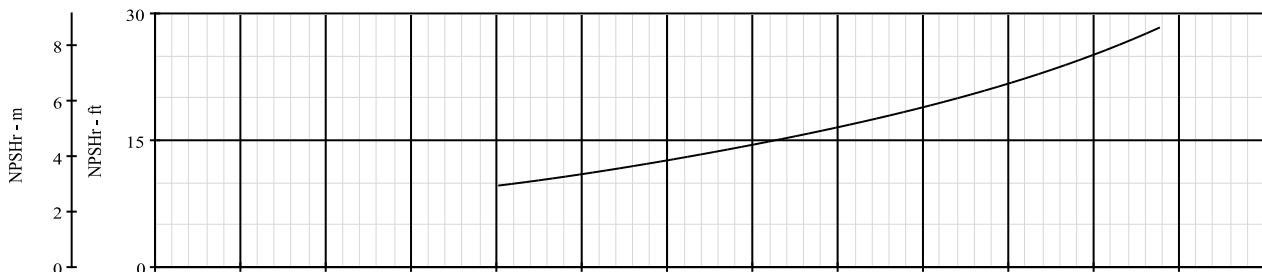
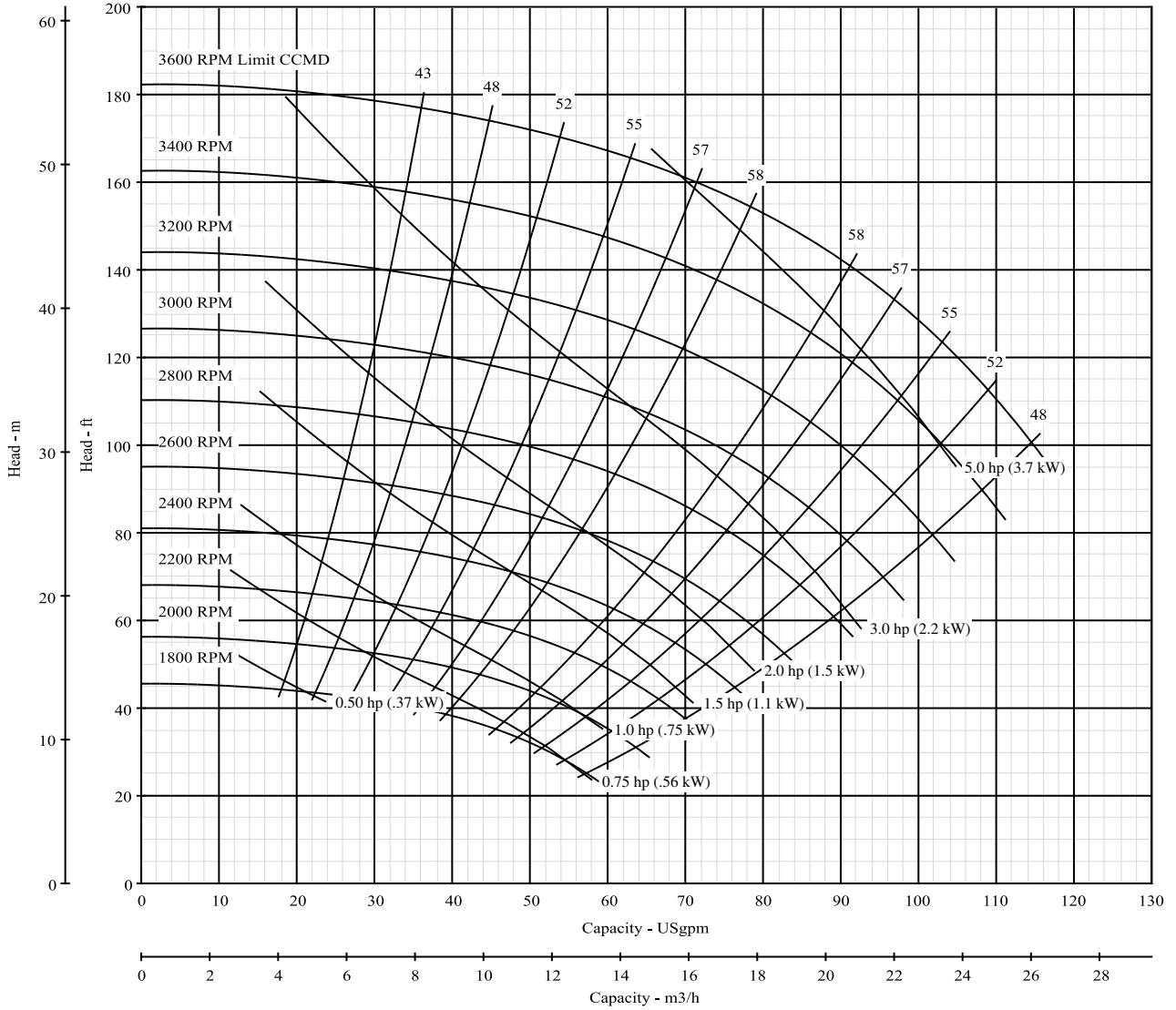

*NPSH data shown is at maximum speed

Pump Size: 1-1/2 x 2 x 6 M

Model: B1-1/2T_M

Curve No. 8888

Type	CCMD	FM CPLG	FM BELT	SAE	Hydraulic	AC Engine
Model	B1-1/2TPM					B1-1/2TQMS-11 (6.13" Diameter Impeller)

Nominal RPM: **3450**
 Based on Fresh Water @ **68°F (20°C)**
 Maximum Working Pressure: 150 PSI (10 BAR)

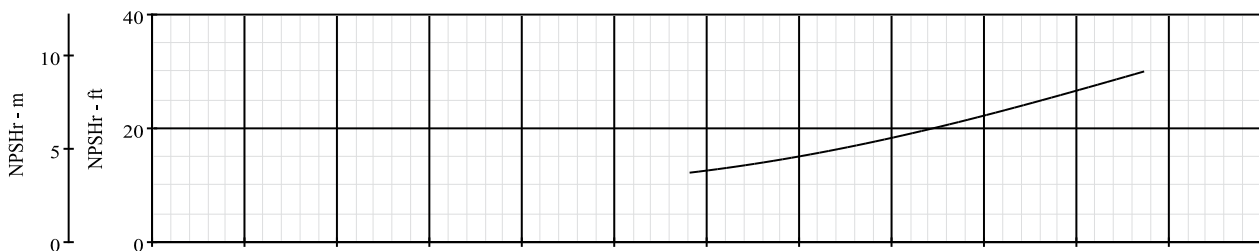
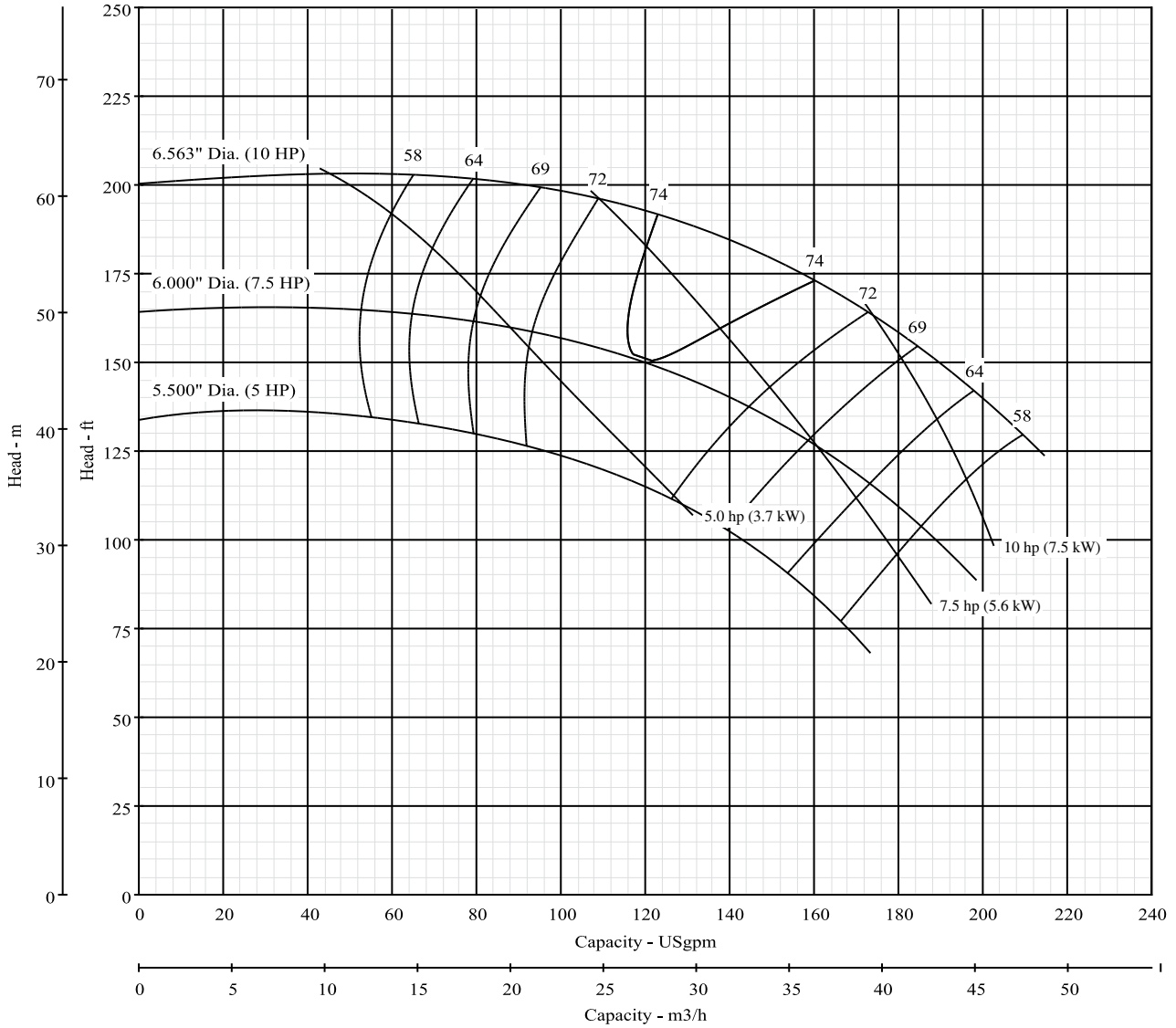

Pump Size: 1-1/2 x 2 x 6 M

Model: B1-1/2T_M

Curve No. 8888

Type	CCMD	FM CPLG	FM BELT	SAE	Hydraulic	AC Engine
Model	B1-1/2TPM					
RPM	1801-3600					

Dia. 6.56"

Nominal RPM: **VARIOUS**
 Based on Fresh Water @ 68°F (20°C)
 Maximum Working Pressure: 150 PSI (10 BAR)

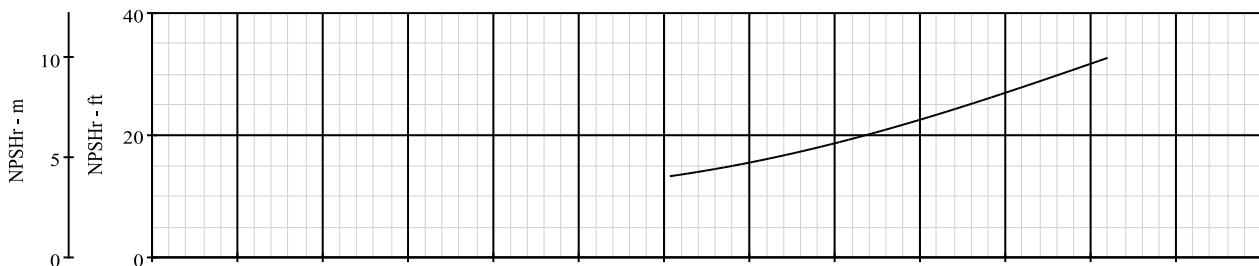
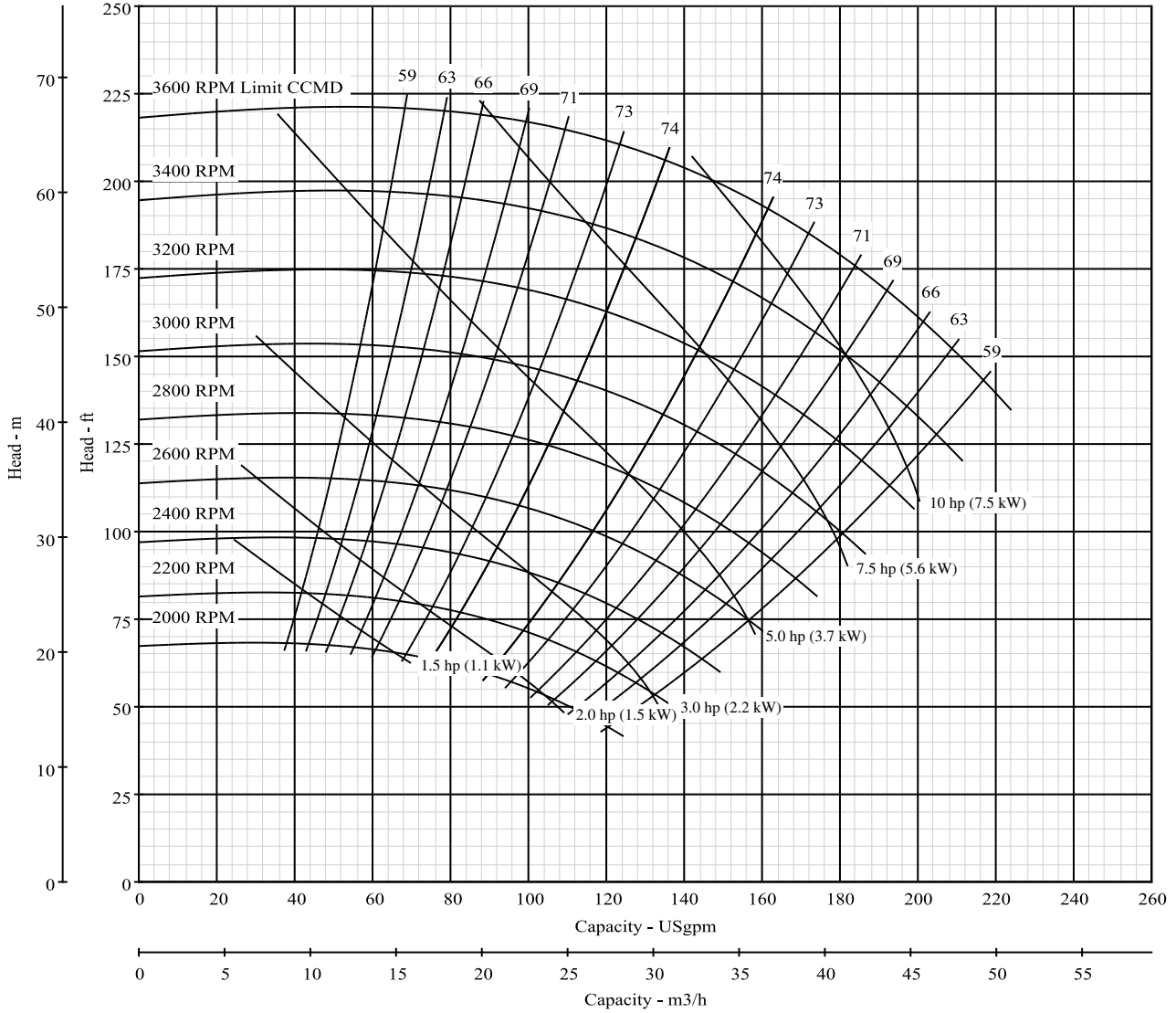

*NPSH data shown is at maximum speed

Pump Size: 2 x 2-1/2 x 6 M

Model: B2T_M

Curve No. 8578

Type	CCMD	FM CPLG	FM BELT	SAE	Hydraulic	AC Engine
Model	B2TPM					B2TQMS-13.5 (6.10" Diameter Impeller)

Nominal RPM: **3450**
 Based on Fresh Water @ **68°F (20°C)**
 Maximum Working Pressure: 150 PSI (10 BAR)

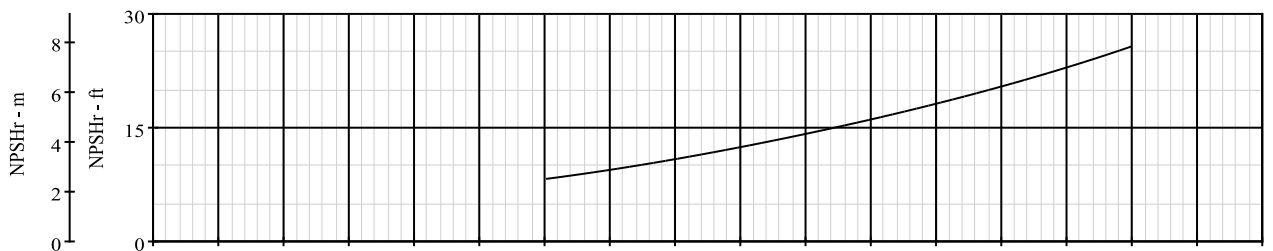
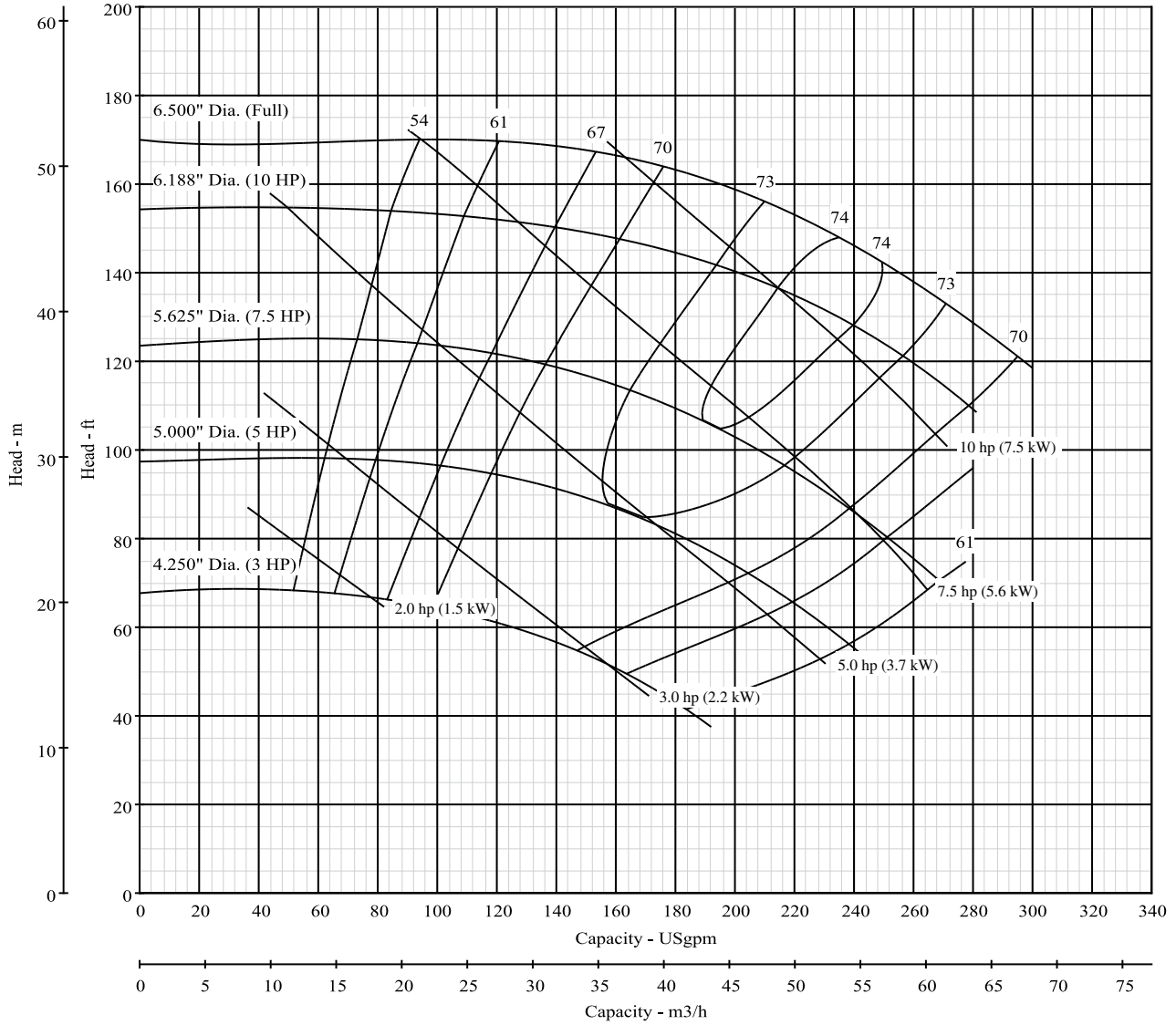

Pump Size: 2 x 2-1/2 x 6 M

Model: B2T_M

Curve No. 8578

Type	CCMD	FM CPLG	FM BELT	SAE	Hydraulic	AC Engine
Model	B2TPM	B2TRMS	B2TRMS			
RPM	1801-3600	1800-3000	1800-3000			

Dia. 6.50"

Nominal RPM: **VARIOUS**
 Based on Fresh Water @ 68°F (20°C)
 Maximum Working Pressure: 150 PSI (10 BAR)

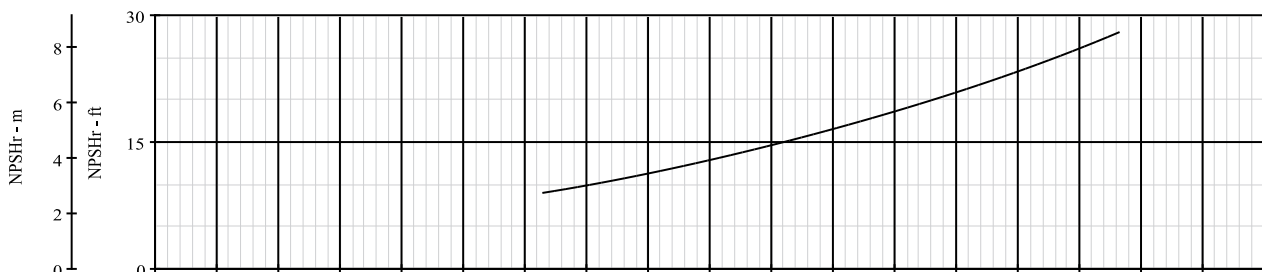
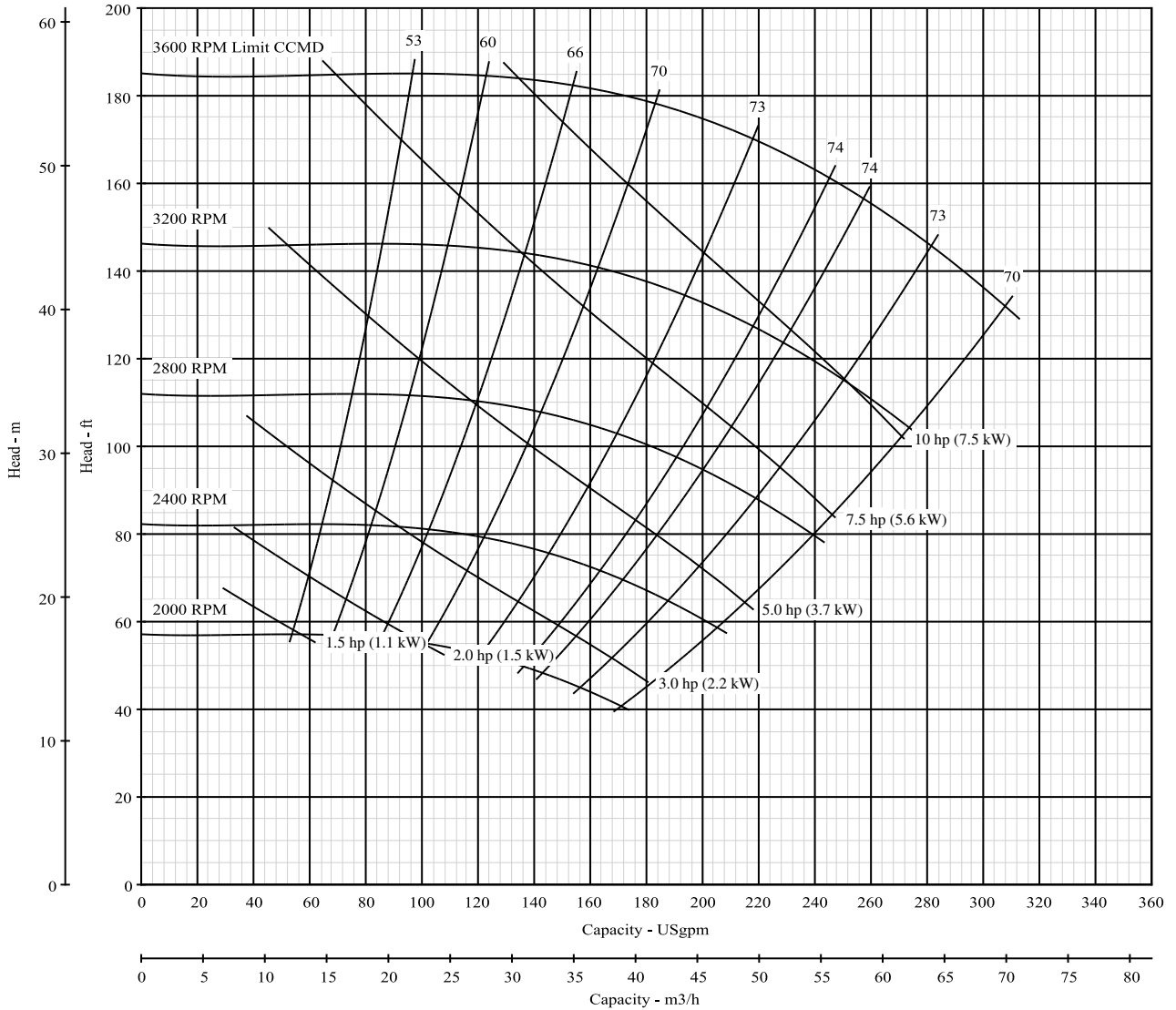

*NPSH data shown is at maximum speed

Pump Size: 2-1/2 x 3 x 6 M

Model: B2-1/2T_M

Curve No. 8477

Type	CCMD	FM CPLG	FM BELT	SAE	Hydraulic	AC Engine
Model	B2-1/2TPM					B2-1/2TQMS-13.5 (5.50" Diameter Impeller)

Nominal RPM: **3450**
 Based on Fresh Water @ **68°F (20°C)**
 Maximum Working Pressure: 150 PSI (10 BAR)

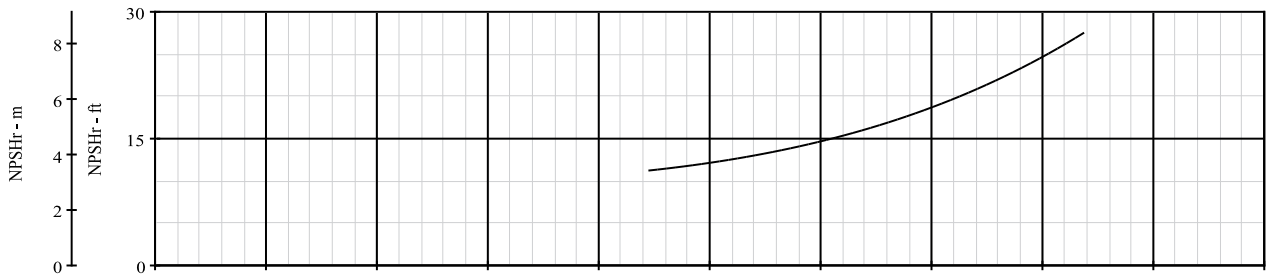
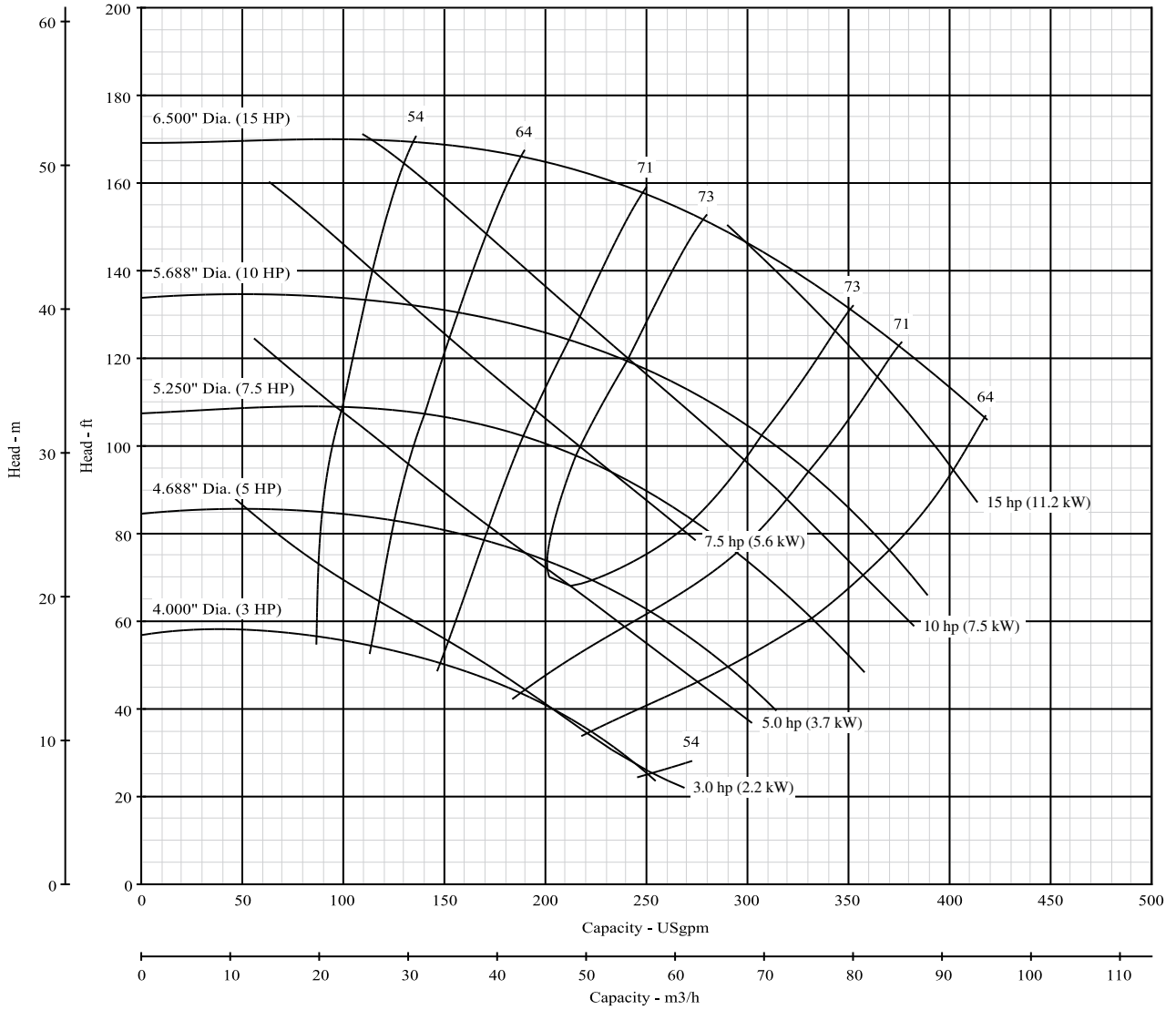

Pump Size: 2-1/2 x 3 x 6 M

Model: B2-1/2T_M

Curve No. 8477

Type	CCMD	FM CPLG	FM BELT	SAE	Hydraulic	AC Engine
Model	B2-1/2TPM	B2-1/2TRMS	B2-1/2TRMS			

Nominal RPM: **1750**
 Based on Fresh Water @ **68°F (20°C)**
 Maximum Working Pressure: 150 PSI (10 BAR)

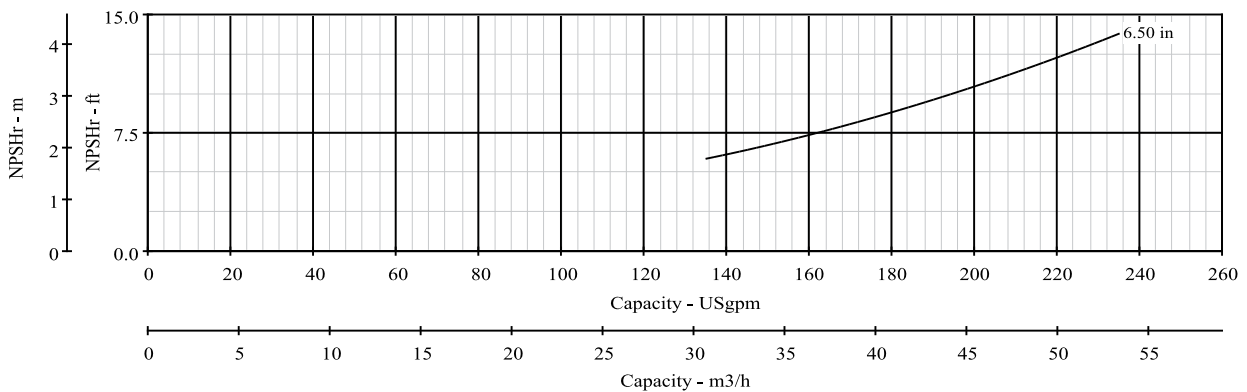
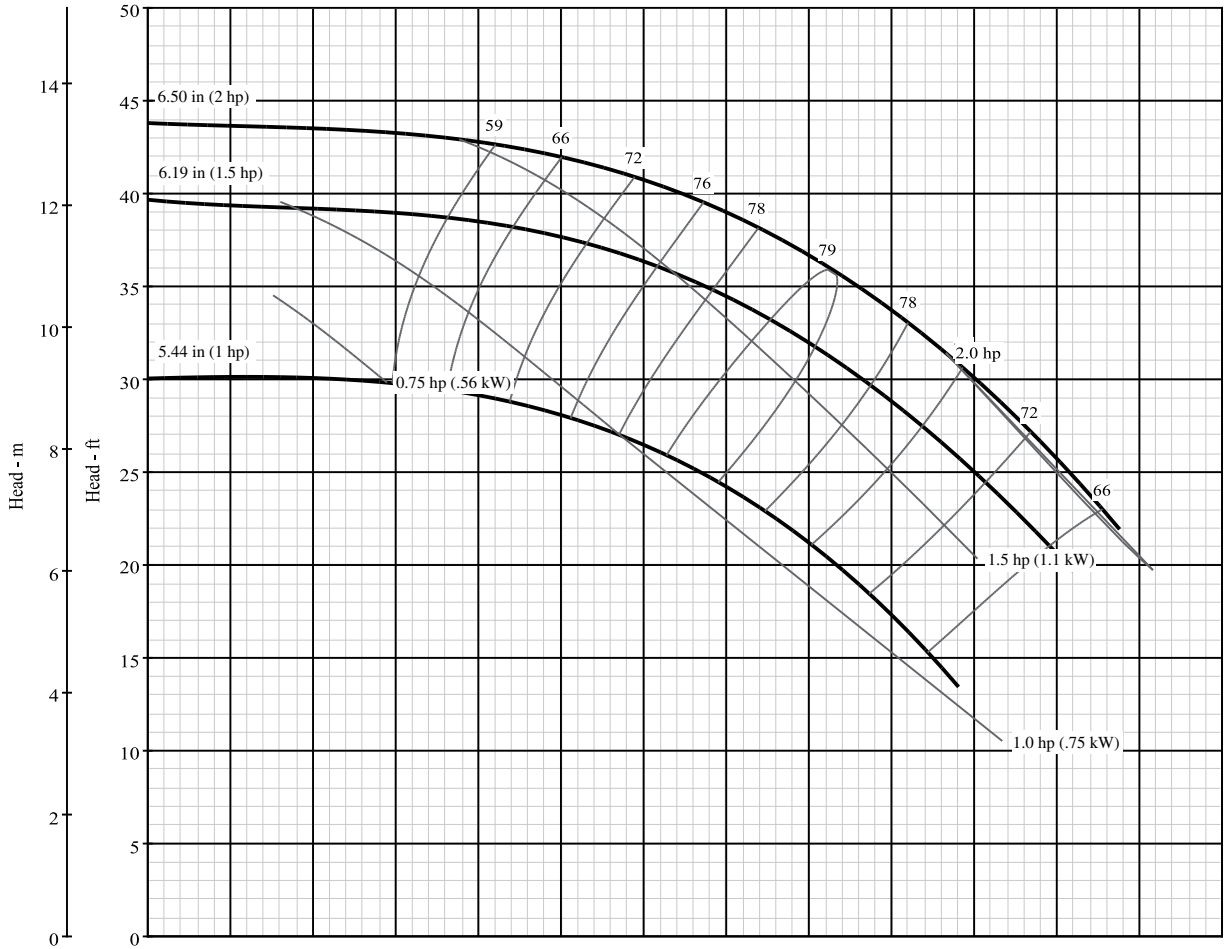

Pump Size: 2-1/2 x 3 x 6 M

Model: B2-1/2T_M

Curve No. 8477

Type	CCMD	FM CPLG	FM BELT	SAE	Hydraulic	AC Engine
Model	B2-1/2TPM	B2-1/2TRMS	B2-1/2TRMS			
RPM	1201-3600	1400-2800	1400-2800			

Dia. 6.50"

Nominal RPM: **VARIOUS**
 Based on Fresh Water @ 68°F (20°C)
 Maximum Working Pressure: 150 PSI (10 BAR)

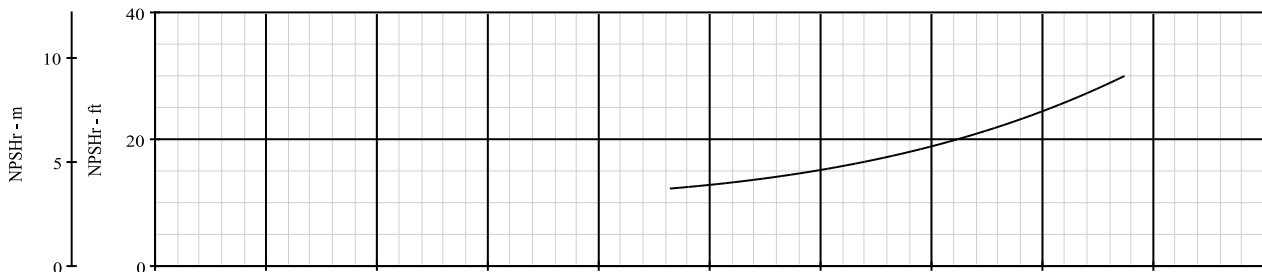
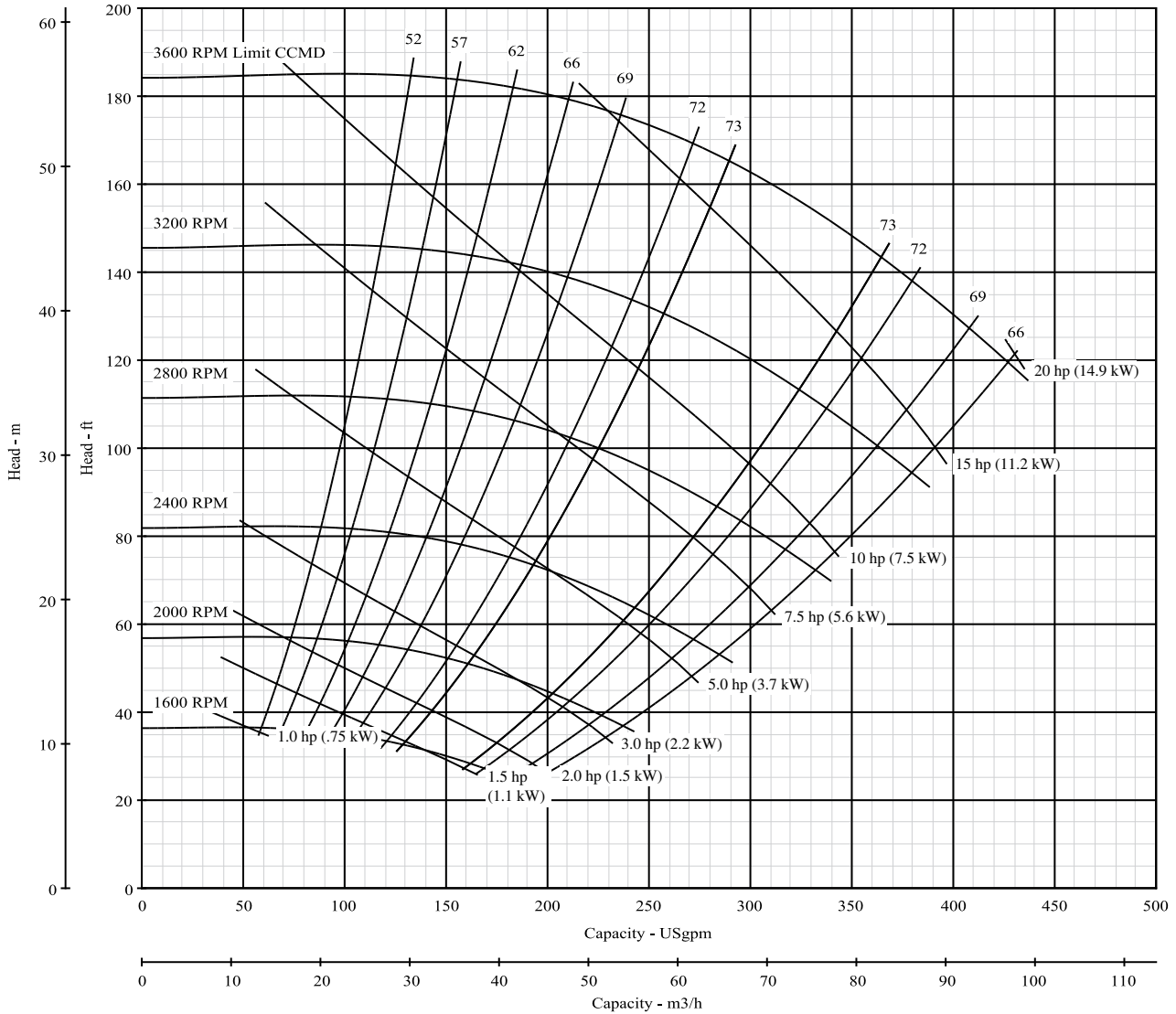

*NPSH data shown is at maximum speed

Pump Size: 3 x 4 x 6 M

Model: B3T_M

Curve No. 5005

Type	CCMD	FM CPLG	FM BELT	SAE	Hydraulic	AC Engine
Model	B3TPM					B3TQMS-18 (5.875" Diameter Impeller)

Nominal RPM: **3450**
 Based on Fresh Water @ **68°F (20°C)**
 Maximum Working Pressure: 150 PSI (10 BAR)

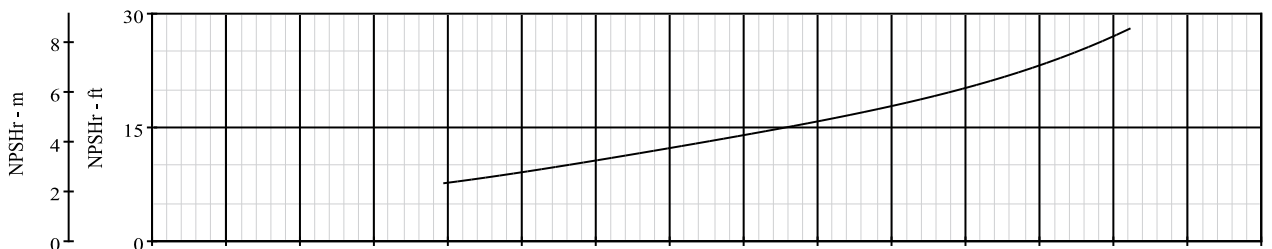
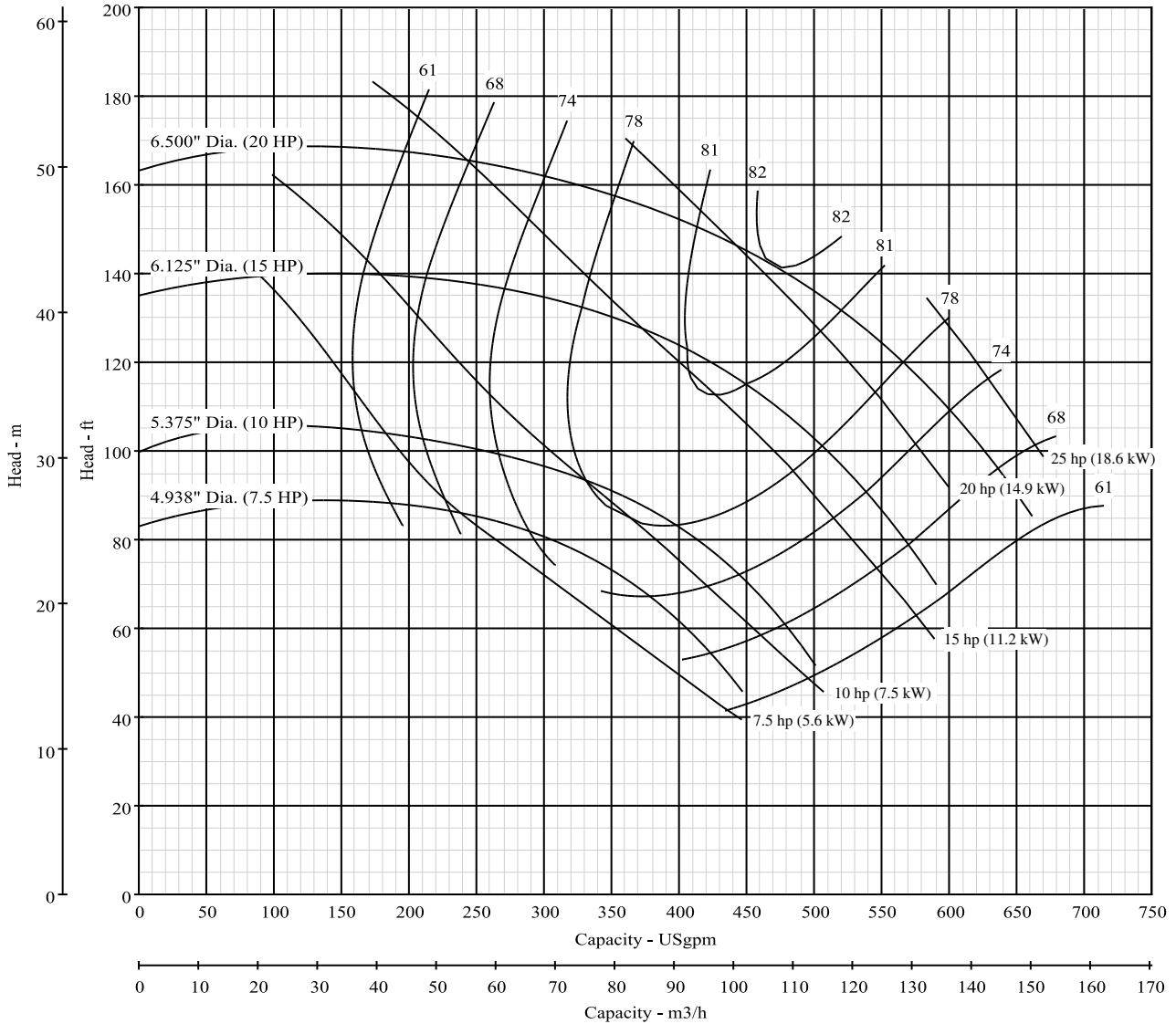

Pump Size: 3 x 4 x 6 M

Model: B3T_M

Curve No. 5005

Type	CCMD	FM CPLG	FM BELT	SAE	Hydraulic	AC Engine
Model	B3TPM	B3TRMS	B3TRMS			

Nominal RPM: **1800**
 Based on Fresh Water @ **68 °F (20 °C)**
 Maximum Working Pressure: 150 PSI (10 BAR)

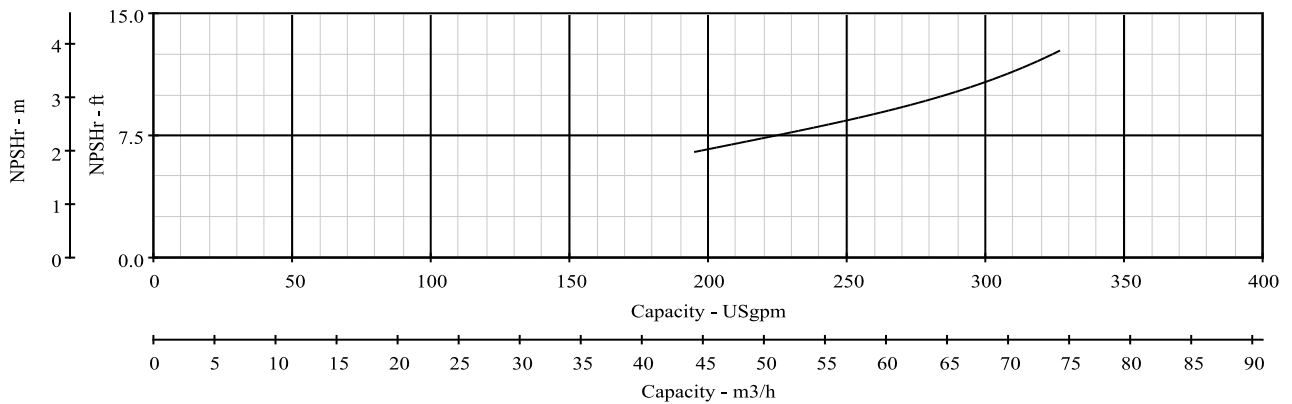
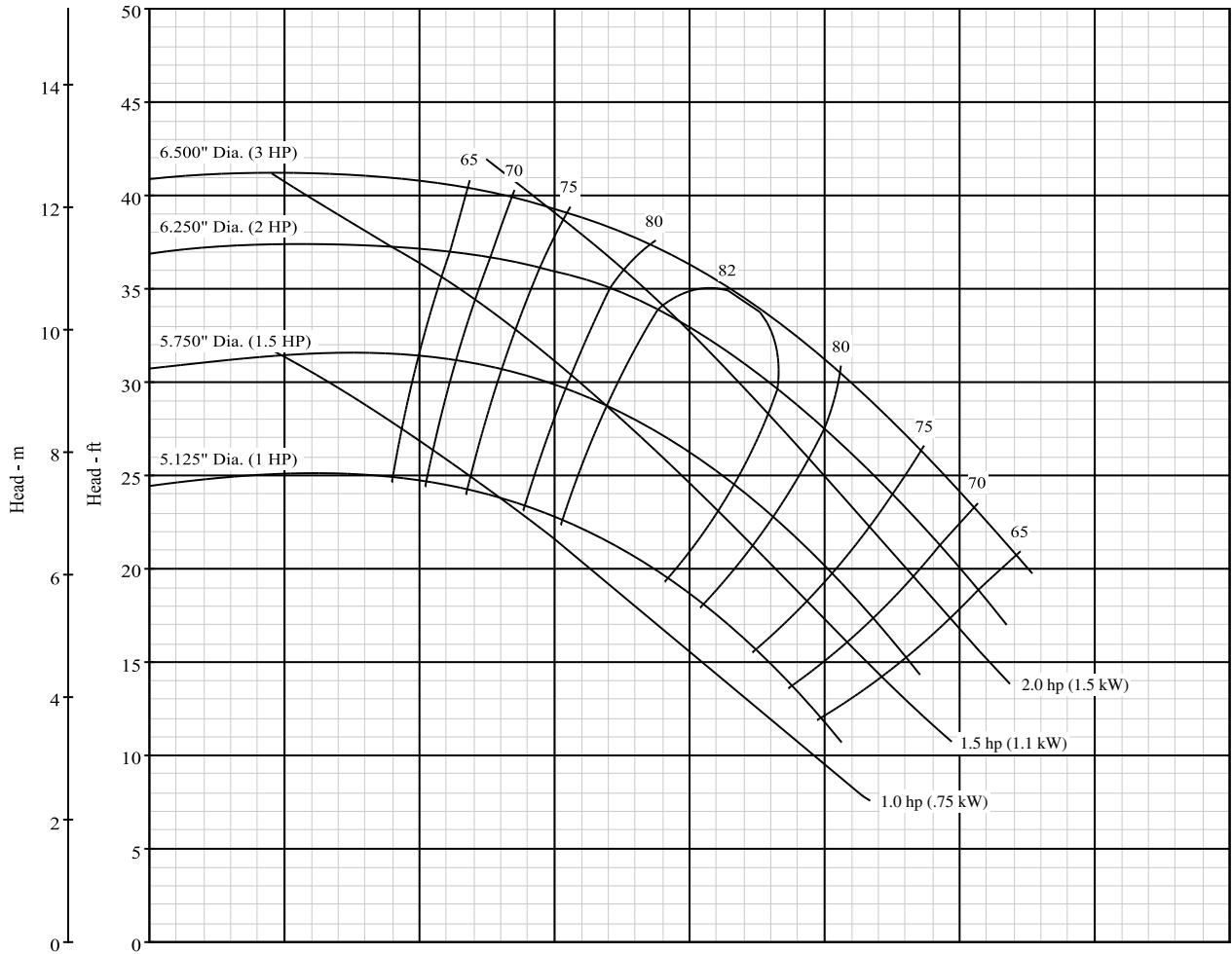

Pump Size: 3 x 4 x 6 M

Model: B3T_M

Curve No. 5005

Type	CCMD	FM CPLG	FM BELT	SAE	Hydraulic	AC Engine
Model	B3TPM	B3TRMS	B3TRMS			
RPM	1201-3600	1400-2400	1400-2400			

Dia. 6.50"

Nominal RPM: **VARIOUS**
 Based on Fresh Water @ 68°F (20°C)
 Maximum Working Pressure: 150 PSI (10 BAR)

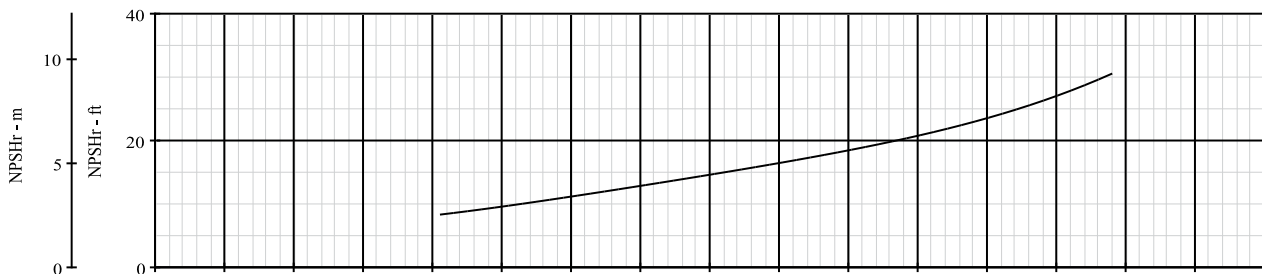
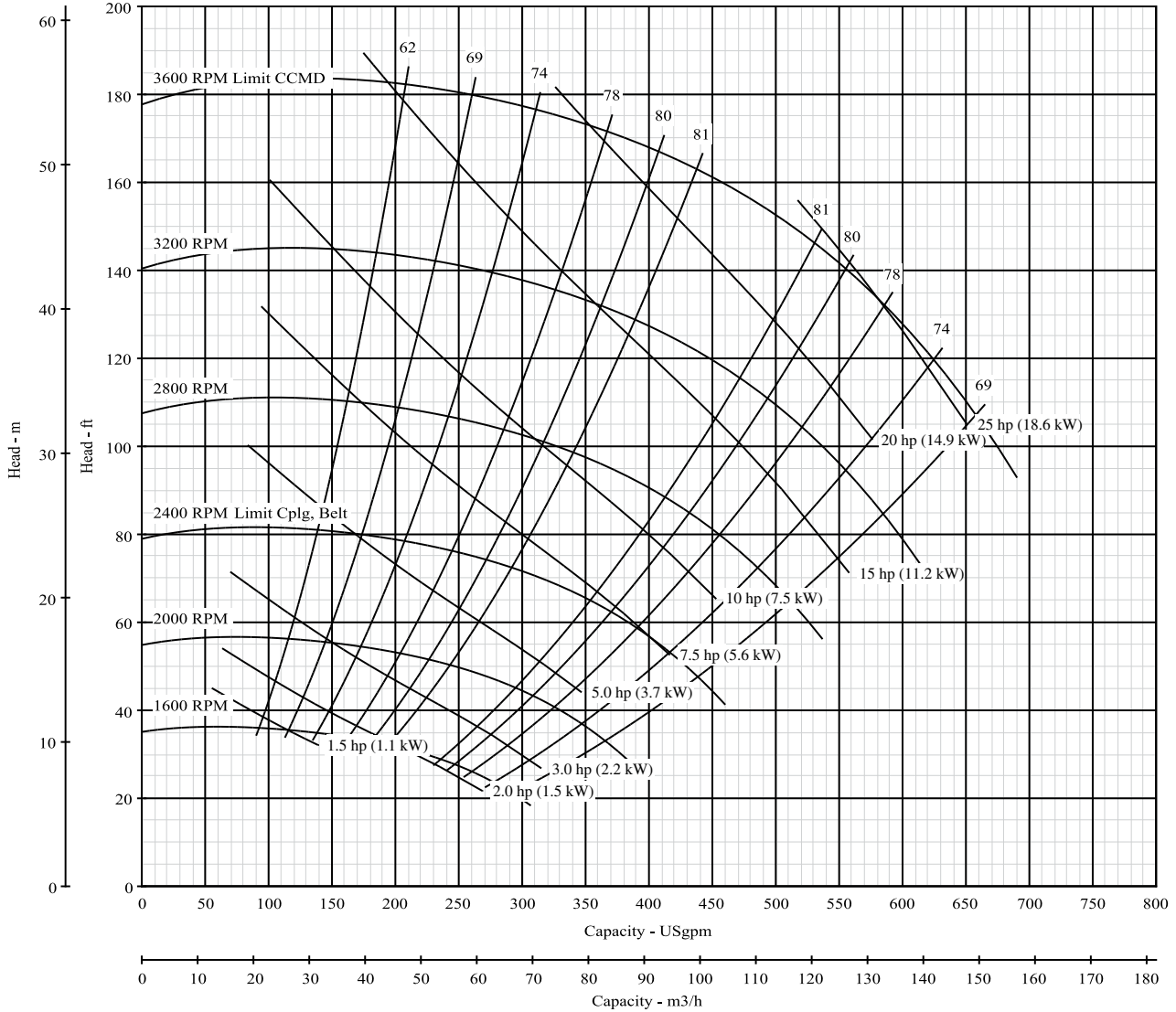

*NPSH data shown is at maximum speed

Pump Size: 3 x 4 x 6 H

Model: B3T_H

Curve No. 9068

Type	CCMD	FM CPLG	FM BELT	SAE	Hydraulic	AC Engine
Model	B3TPH					

Nominal RPM: **3500**
 Based on Fresh Water @ **68 °F (20 °C)**
 Maximum Working Pressure: **266 PSI (18 BAR)**

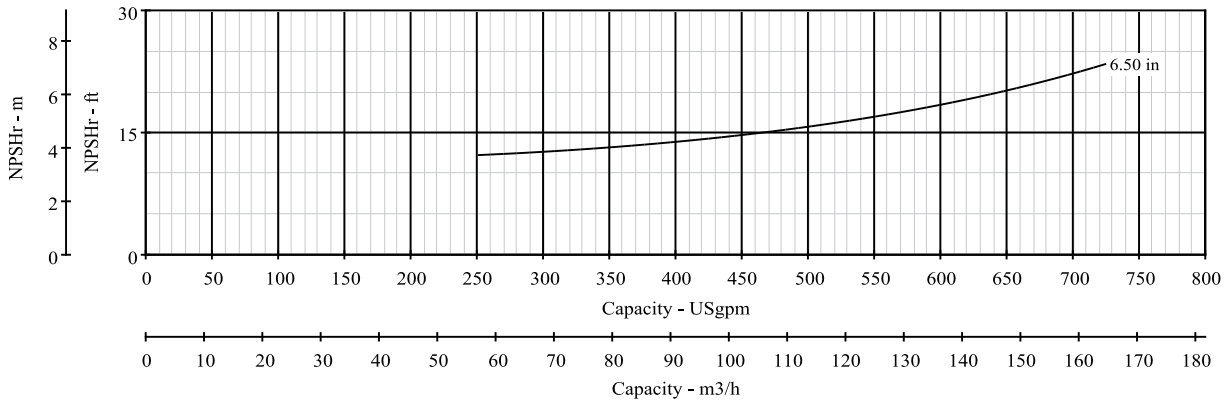
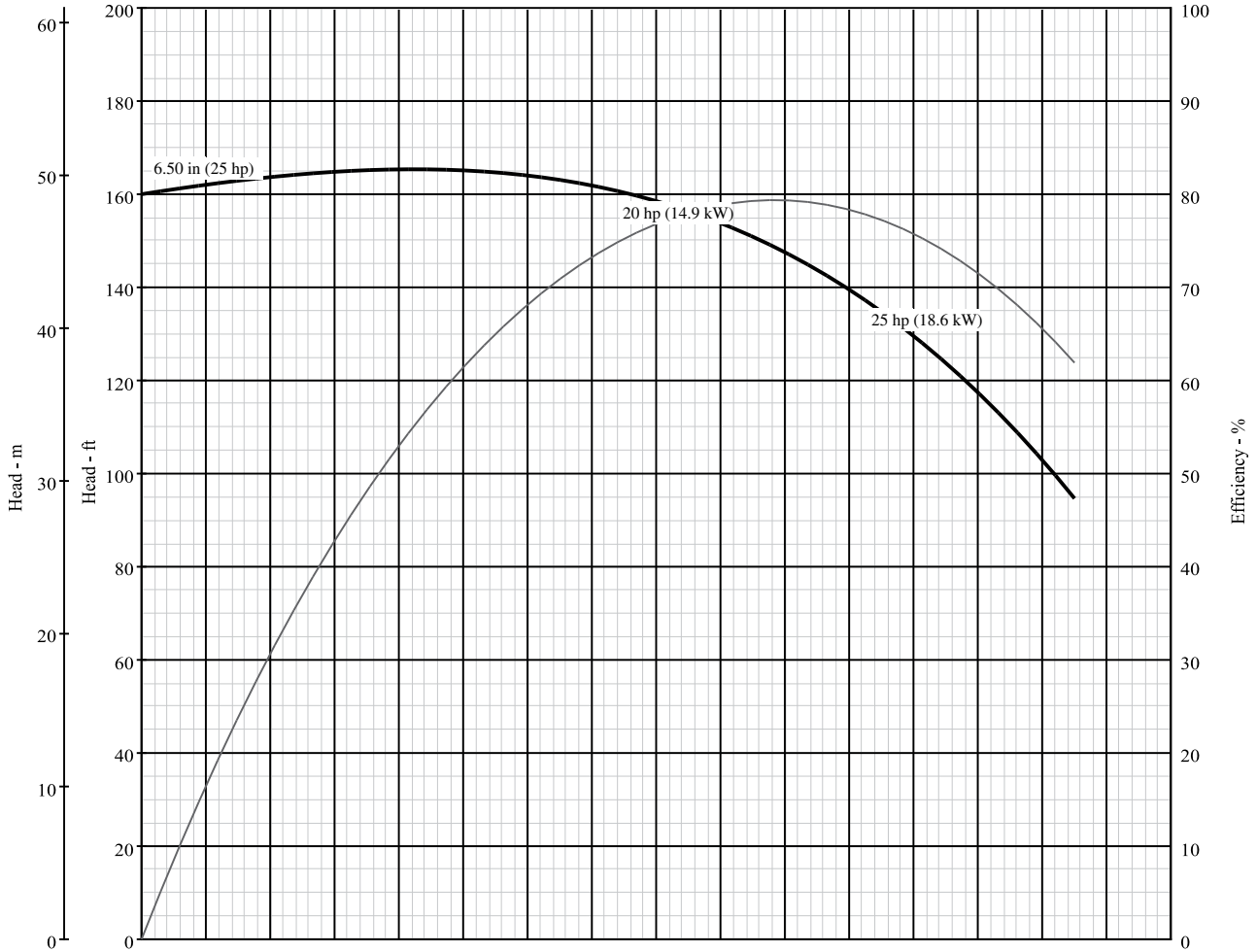

Pump Size: 3 x 4 x 6 H

Model: B3T_H

Curve No. 9068

Type	CCMD	FM CPLG	FM BELT	SAE	Hydraulic	AC Engine
Model	B3TPH					

Nominal RPM: **1750**
 Based on Fresh Water @ **68°F (20°C)**
 Maximum Working Pressure: **266 PSI (18 BAR)**

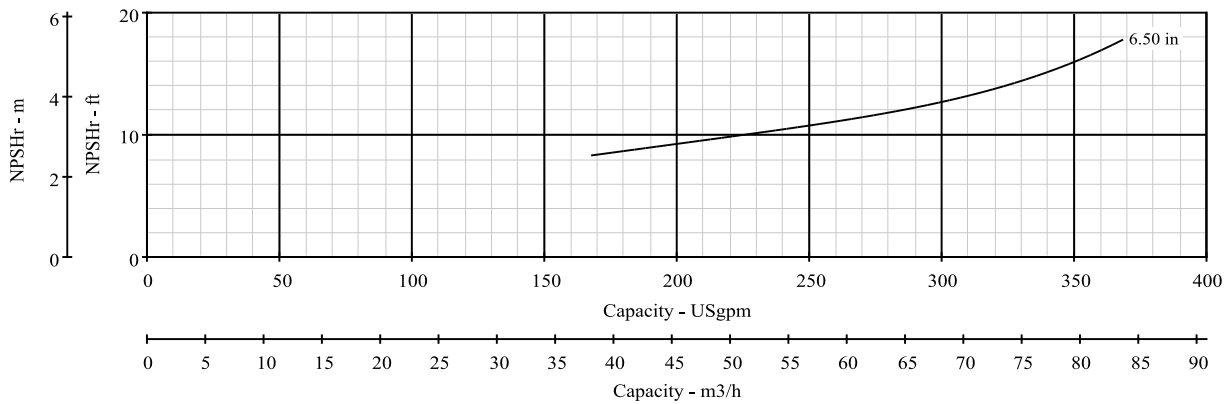
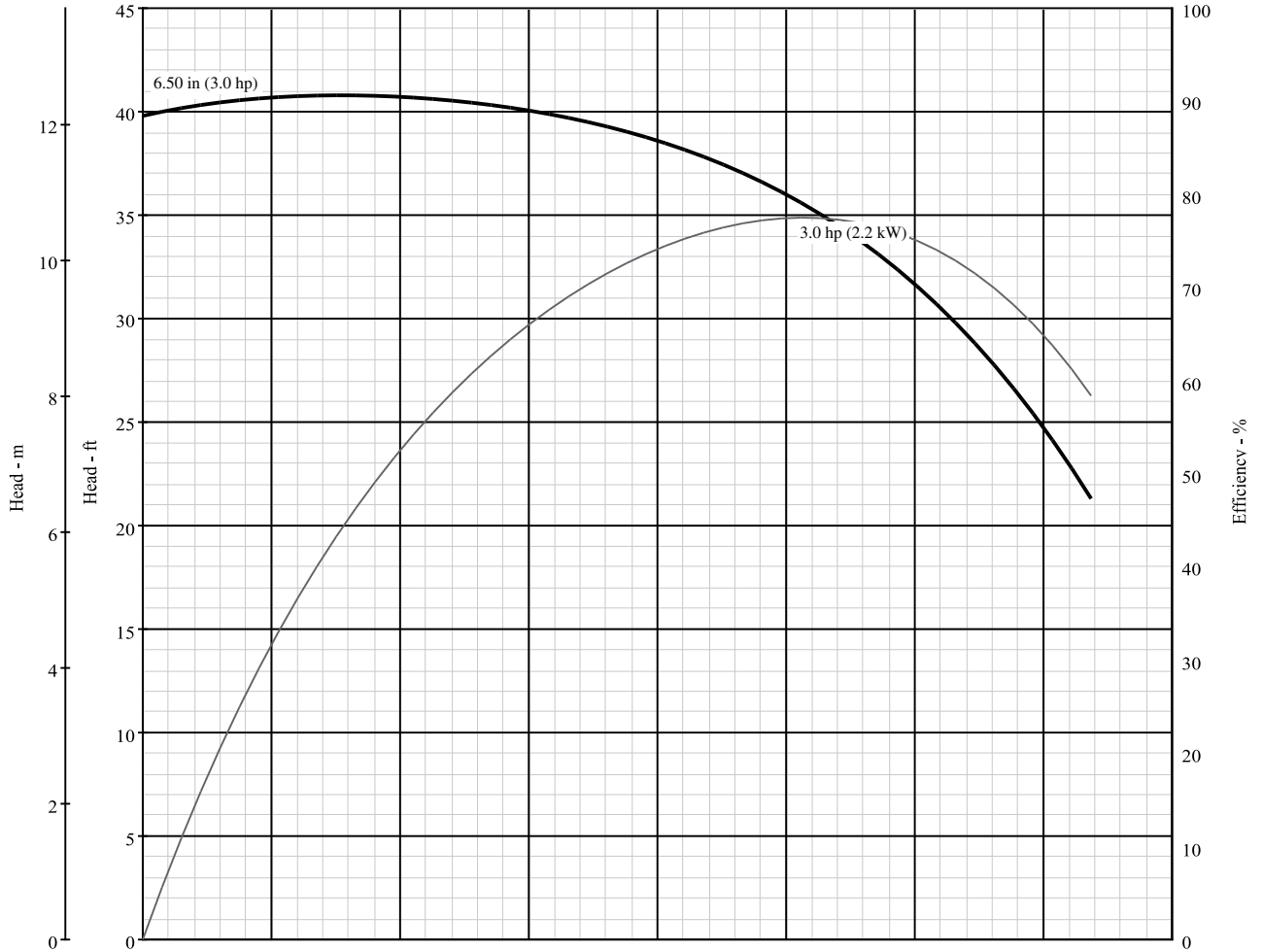

Pump Size: 3 x 4 x 6 H

Model: B3T_H

Curve No. 9068

Type	CCMD	FM CPLG	FM BELT	SAE	Hydraulic	AC Engine
Model	B3TPH					
RPM	1201-3600					

Dia. 6.50"

Nominal RPM: **VARIOUS**
 Based on Fresh Water @ 68°F (20°C)
 Maximum Working Pressure: 266 PSI (18 BAR)

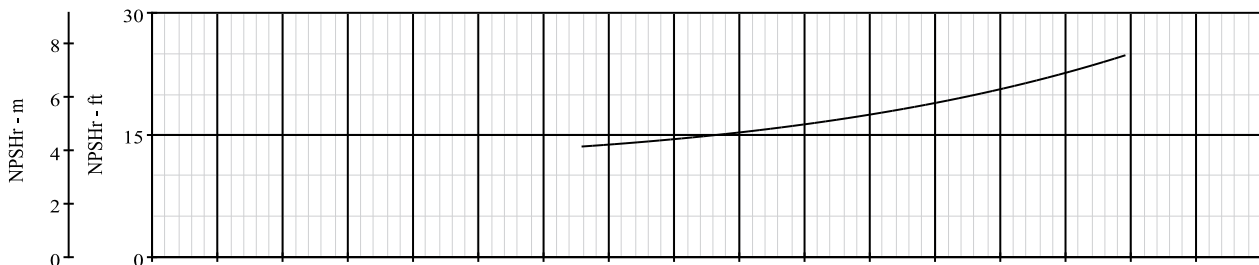
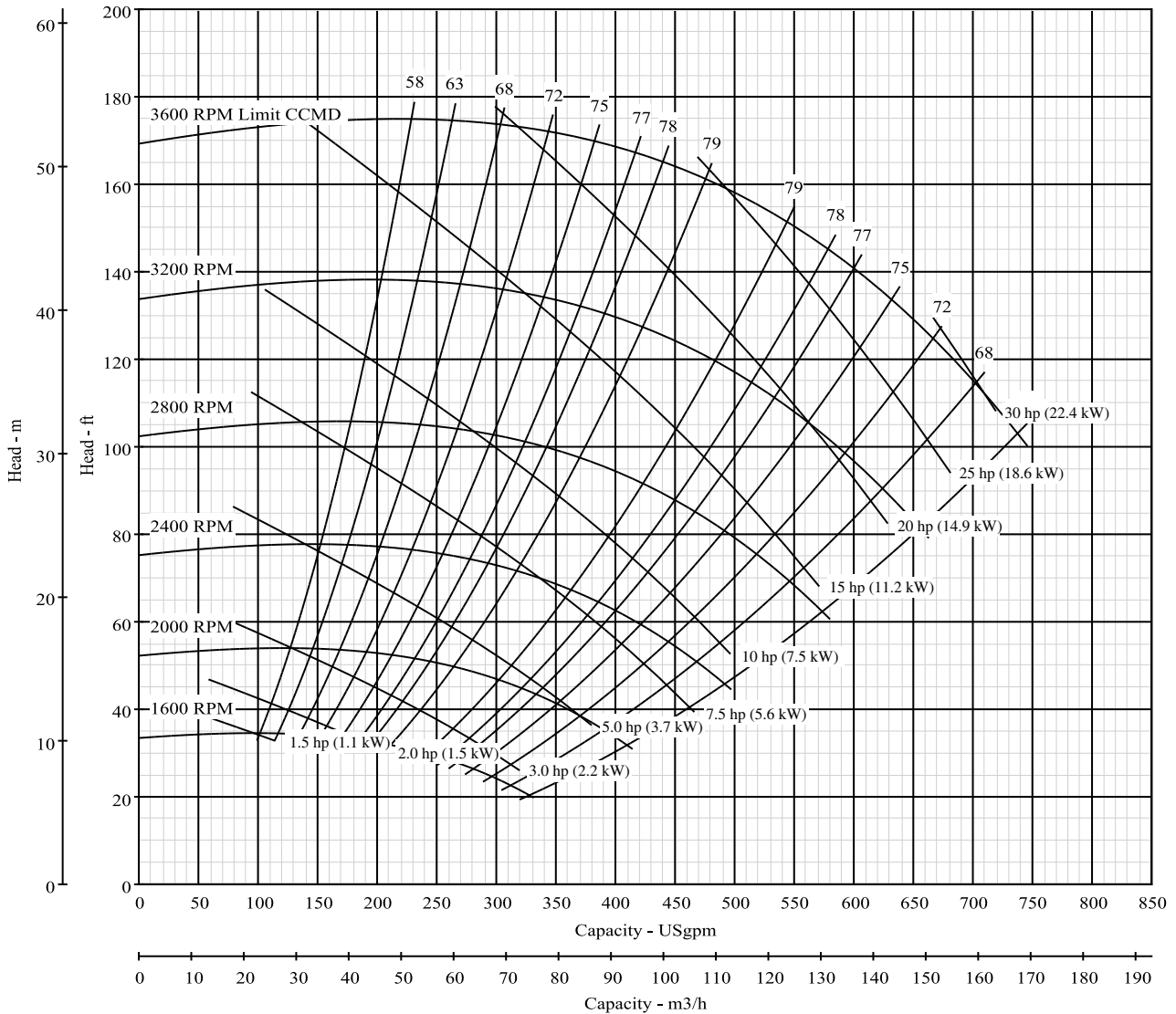

*NPSH data shown is at maximum speed

Pump Size: 3 x 4 x 6 HH

Model: B3T_HH

Curve No. 9069

Type	CCMD	FM CPLG	FM BELT	SAE	Hydraulic	AC Engine
Model	B3TPHH					

Nominal RPM: **3500**
 Based on Fresh Water @ **68 °F (20 °C)**
 Maximum Working Pressure: **266 PSI (18 BAR)**

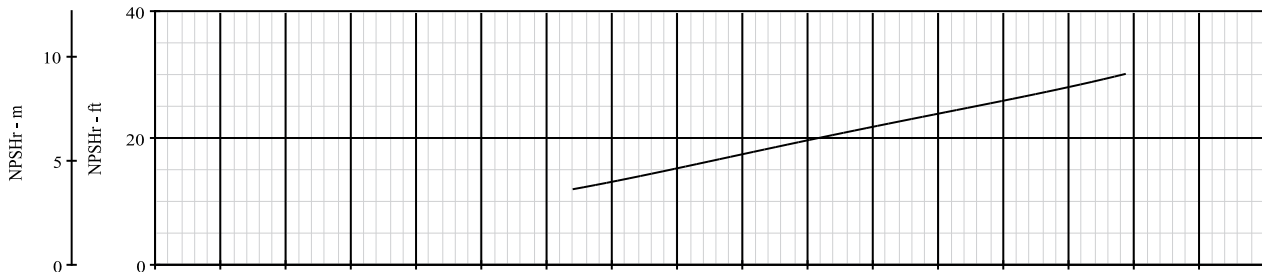
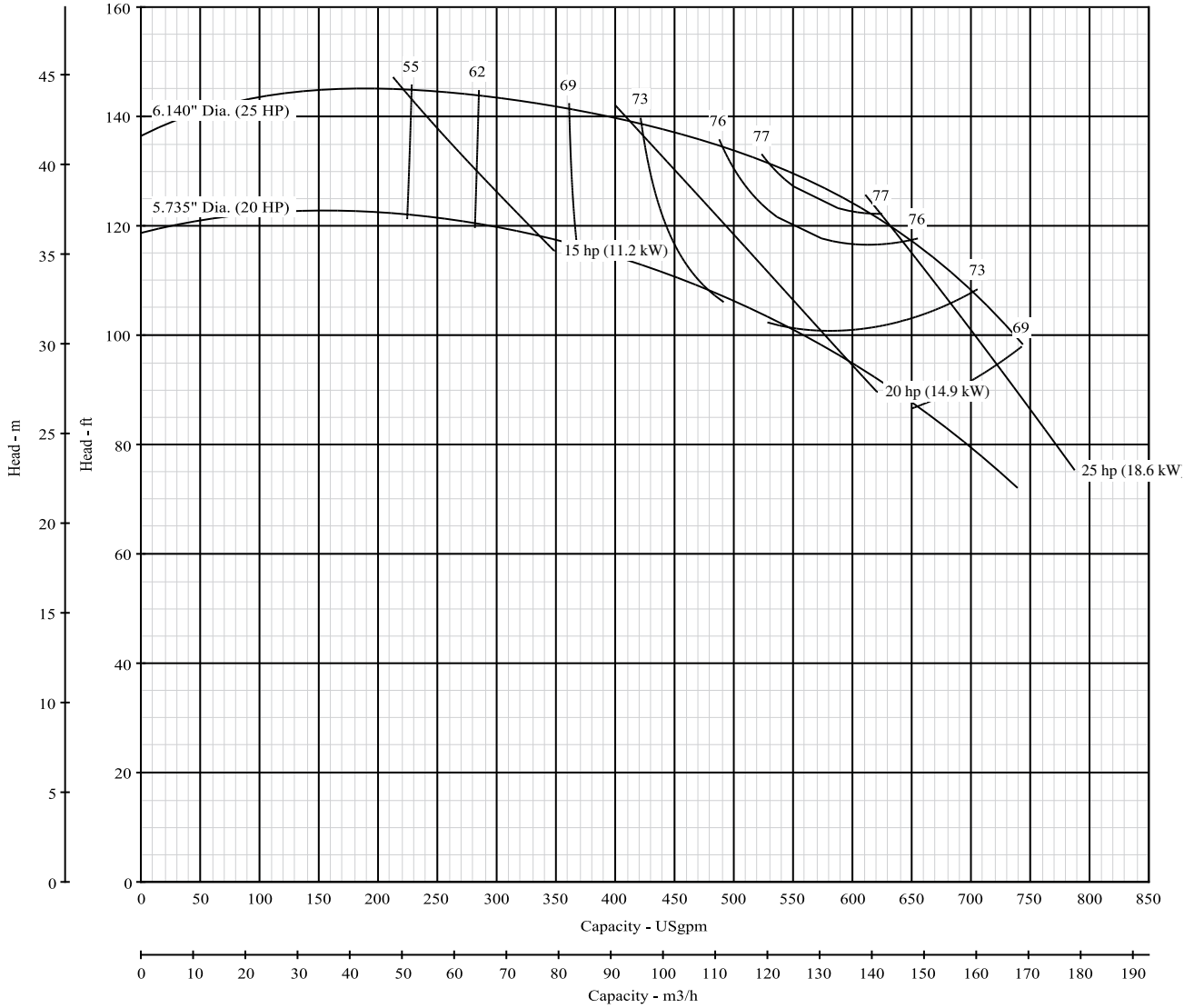

Pump Size: 3 x 4 x 6 HH

Model: B3T_HH

Curve No. 9069

Type	CCMD	FM CPLG	FM BELT	SAE	Hydraulic	AC Engine
Model	B3TPHH					
RPM	1801-3600					

Dia. 6.14"

Nominal RPM: **VARIOUS**
 Based on Fresh Water @ 68°F (20°C)
 Maximum Working Pressure: 266 PSI (18 BAR)

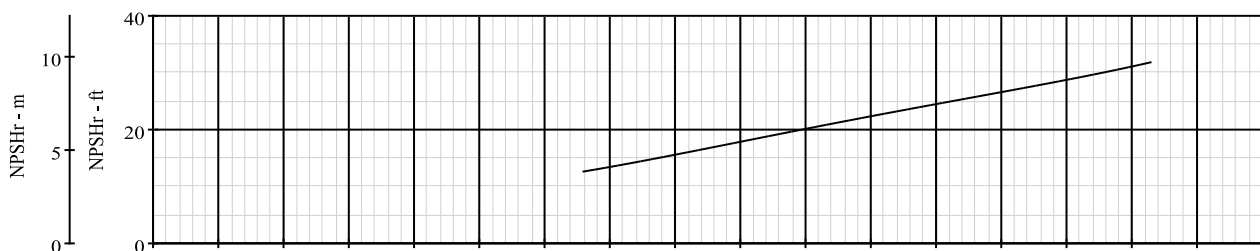
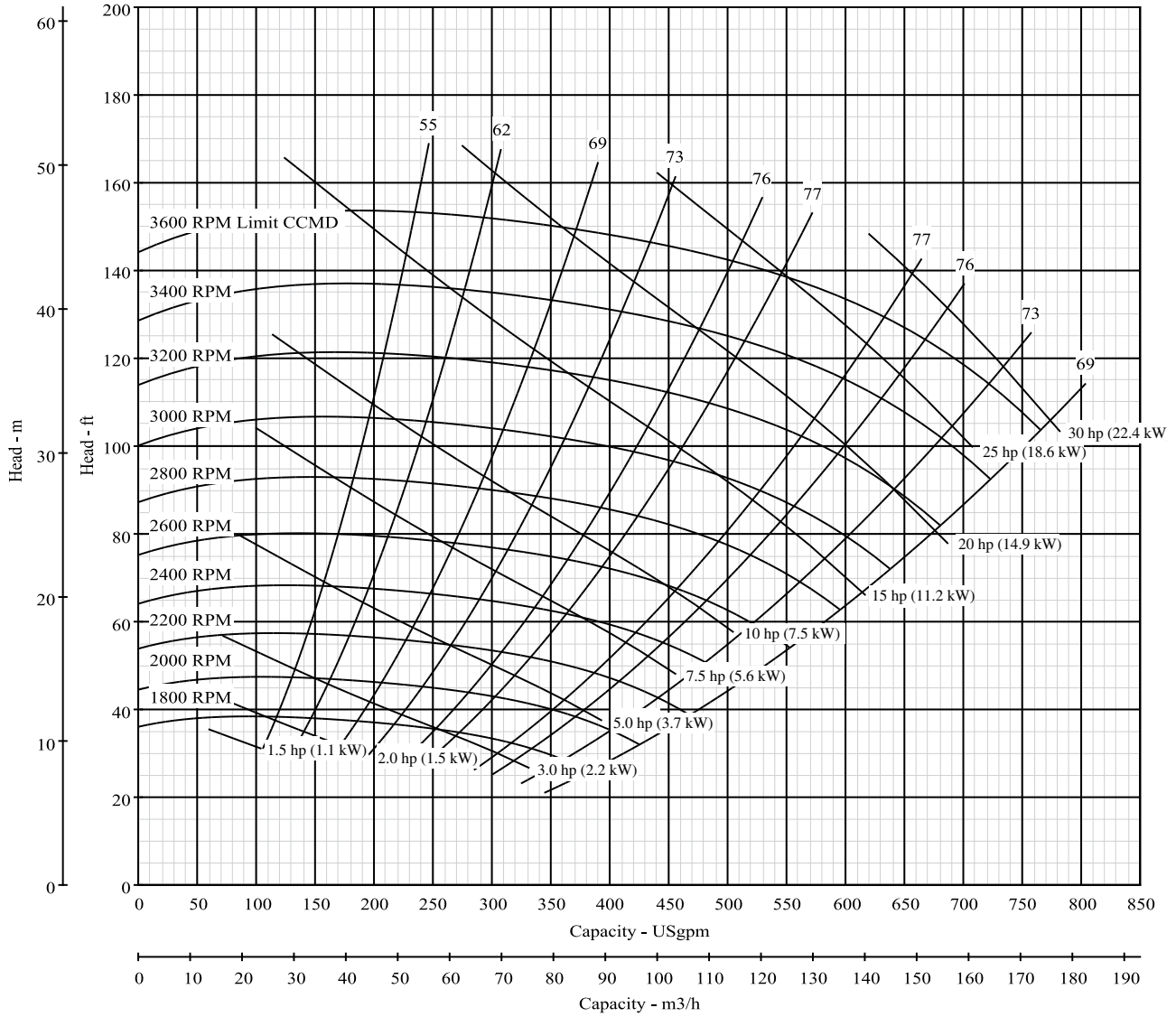

*NPSH data shown is at maximum speed

Pump Size: 1 x 1-1/2 x 7 W

Model: B1W_
Curve No. 8233

Type	CCMD	FM CPLG	FM BELT	SAE	Hydraulic	AC Engine
Model	B1WP					B1WQS-9 (7.35" Diameter Impeller)

Nominal RPM: **3450**
Based on Fresh Water @ **68°F (20°C)**
Maximum Working Pressure: **266 PSI (18 BAR)**

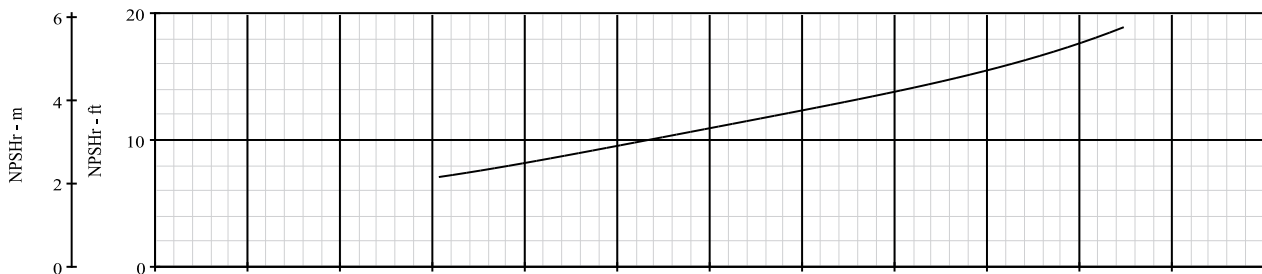
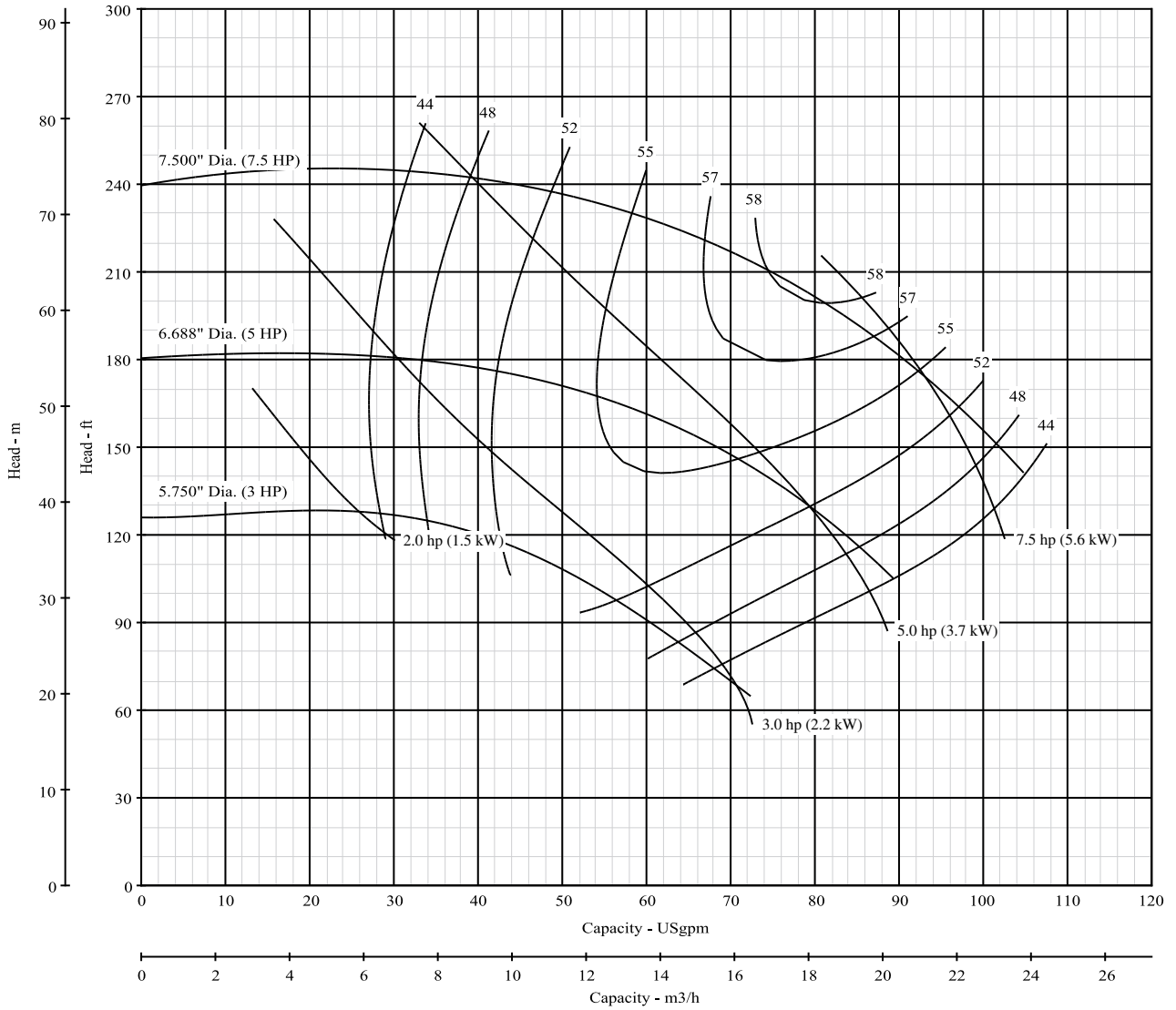

Pump Size: 1 x 1-1/2 x 7

Model: B1W_

Curve No. 8233

Type	CCMD	FM CPLG	FM BELT	SAE	Hydraulic	AC Engine
Model	B1WP					
RPM	1801-3600					

Dia. 7.50"

Nominal RPM: **VARIOUS**
 Based on Fresh Water @ 68°F (20°C)
 Maximum Working Pressure: 266 PSI (18 BAR)

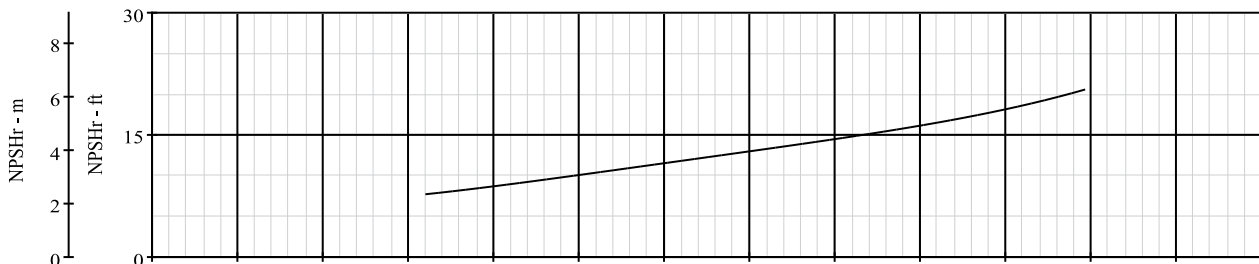
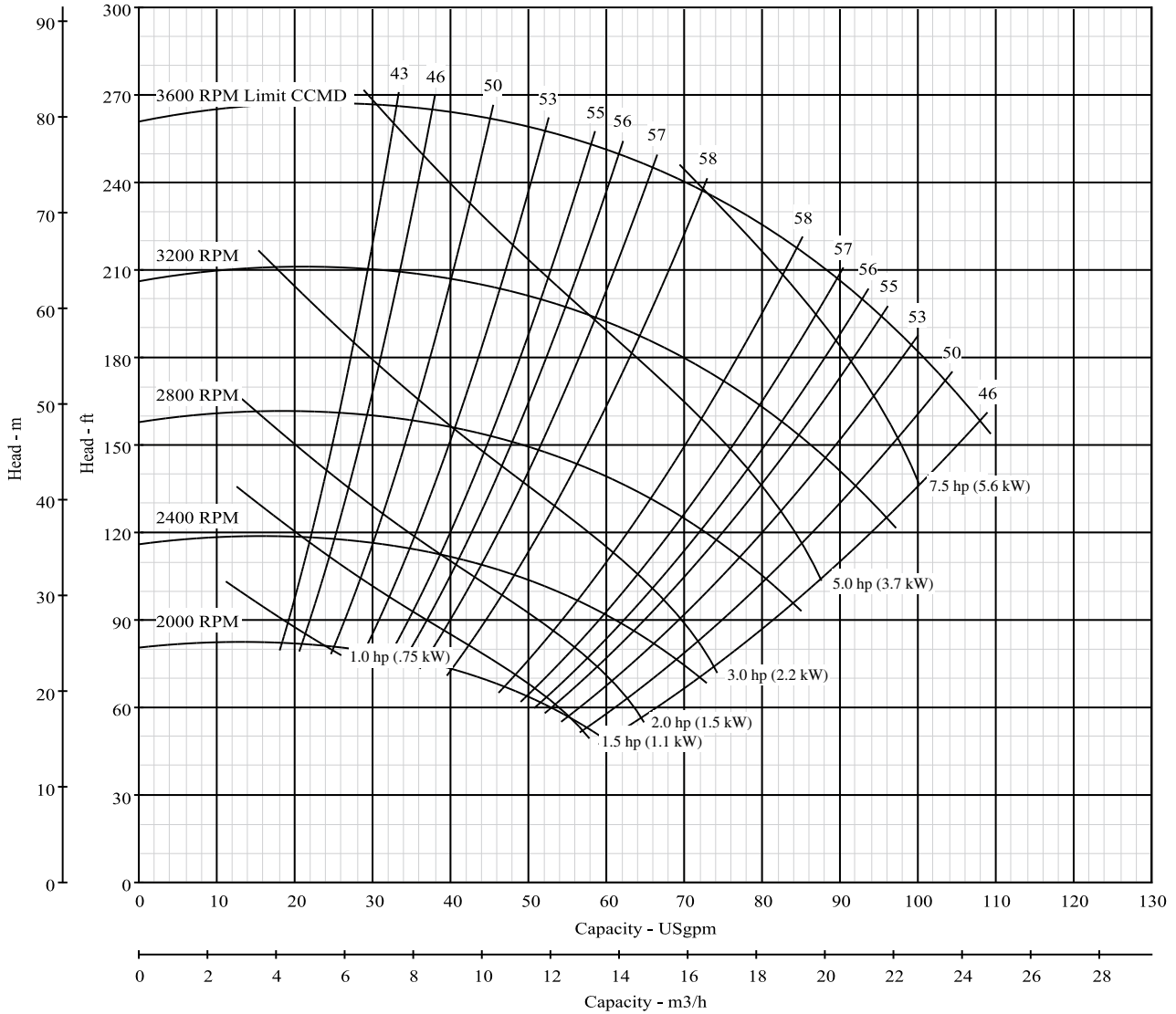

*NPSH data shown is at maximum speed

Pump Size: 5 x 6 x 7

Model: B5W_
Curve No. 3524

Type	CCMD	FM CPLG	FM BELT	SAE	Hydraulic	AC Engine
Model	B5WP					

Nominal RPM: **1740**
Based on Fresh Water @ **68°F (20°C)**
Maximum Working Pressure: **266 PSI (18 BAR)**

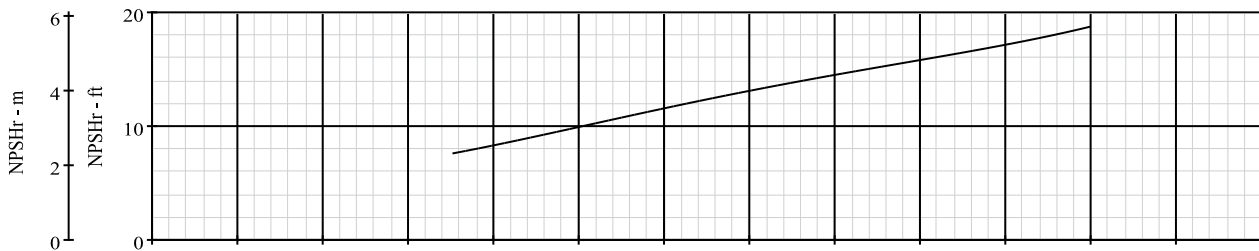
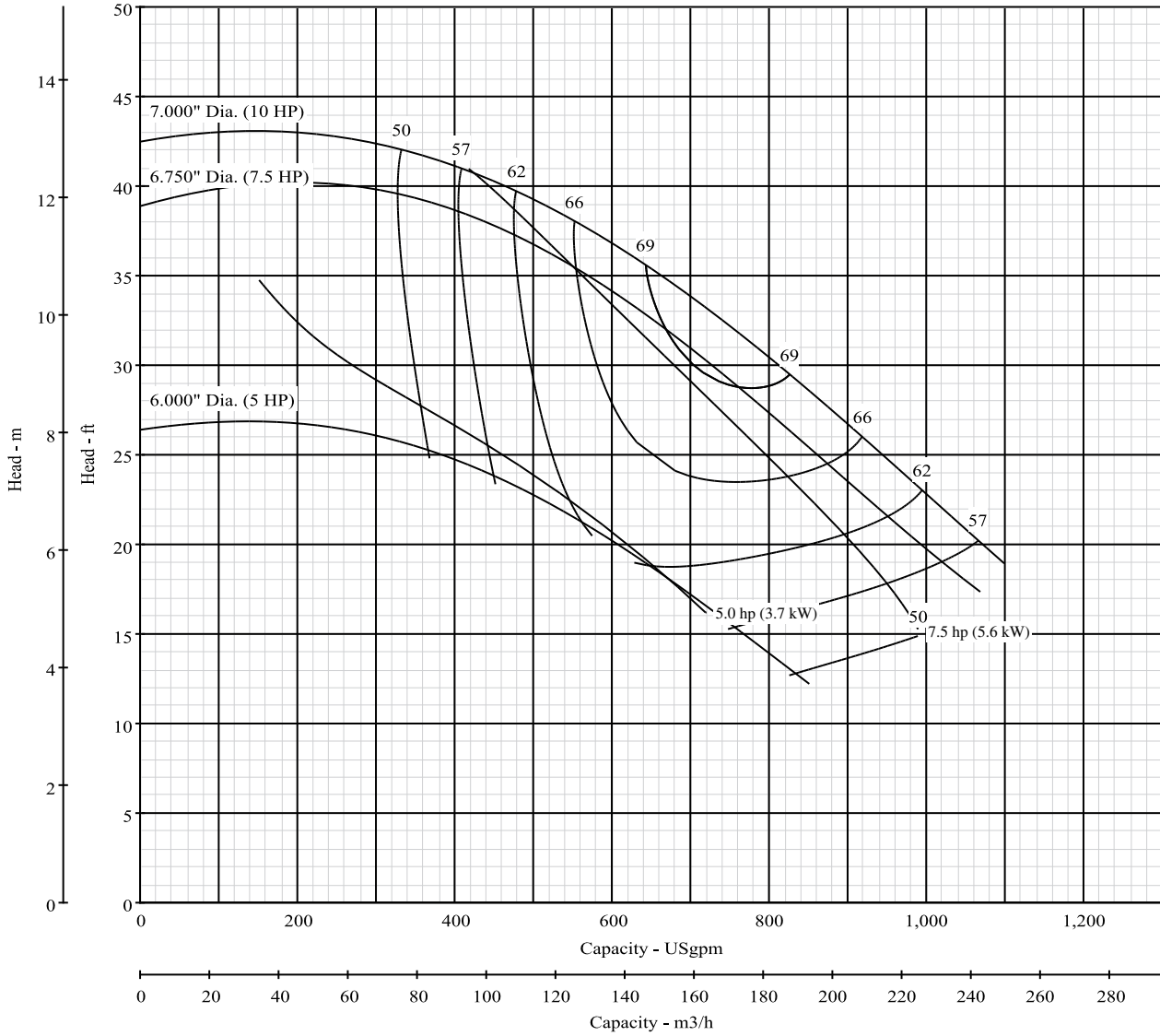

Pump Size: 5 x 6 x 7

Model: B5W_
Curve No. 3524

Type	CCMD	FM CPLG	FM BELT	SAE	Hydraulic	AC Engine
Model	B5WP					
RPM	1201-1800					

Dia. 7.00"

Nominal RPM: **VARIOUS**
Based on Fresh Water @ 68°F (20°C)
Maximum Working Pressure: 266 PSI (18 BAR)

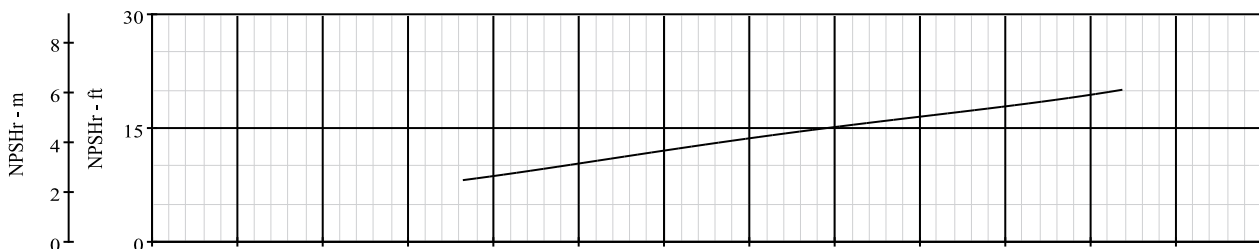
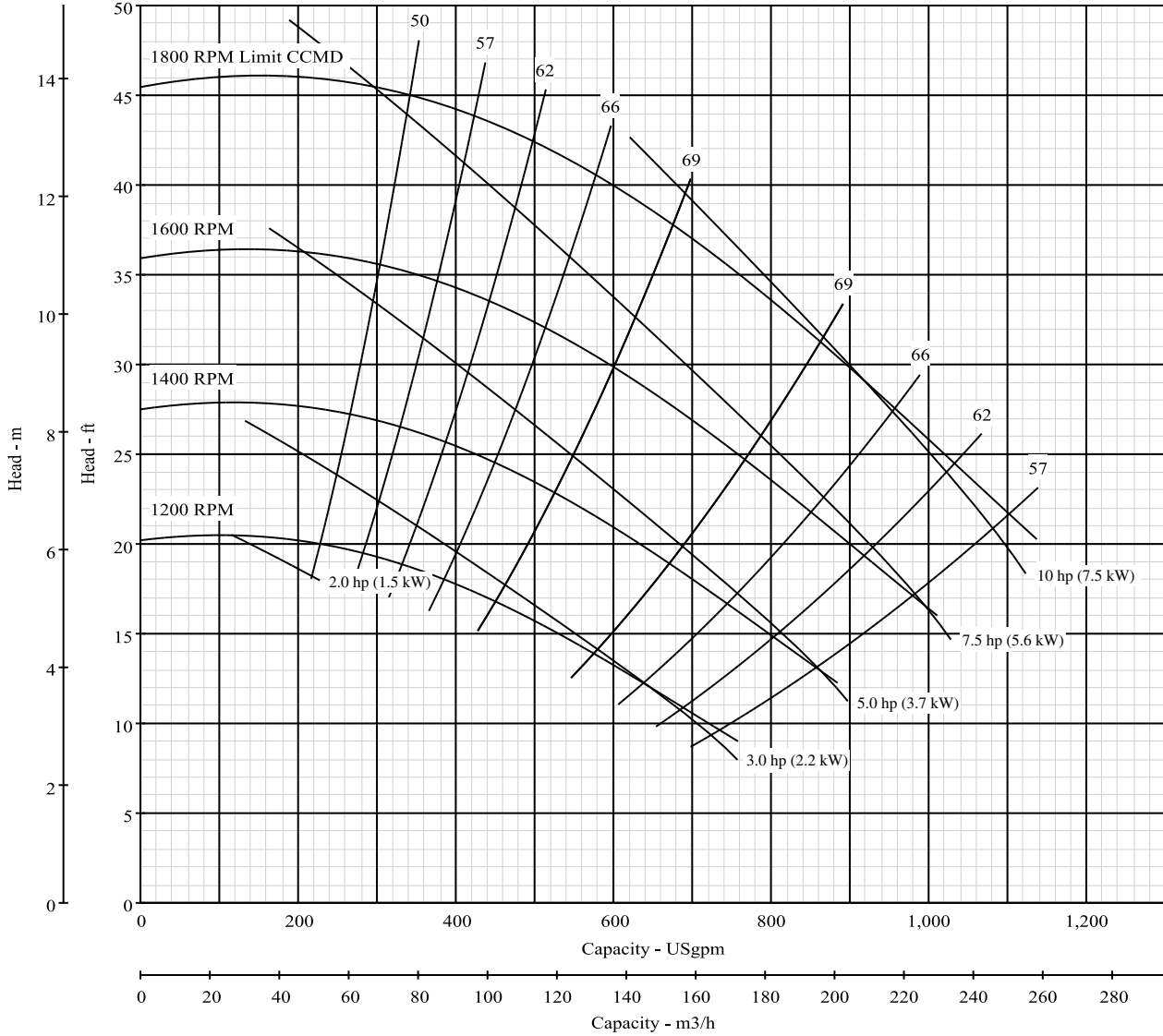

*NPSH data shown is at maximum speed

Pump Size: 1-1/2 x 2 x 9L

Model: B1-1/2Z_L

Curve No. 5036

Type	CCMD	FM CPLG	FM BELT	SAE	Hydraulic	AC Engine
Model	B1-1/2ZPL	B1-1/2ZRL	B1-1/2ZRL			B1-1/2ZQLS-18 (8.41" Diameter Impeller)

Nominal RPM: **3550**
 Based on Fresh Water @ **68°F (20°C)**
 Maximum Working Pressure: **266 PSI (18 BAR)**

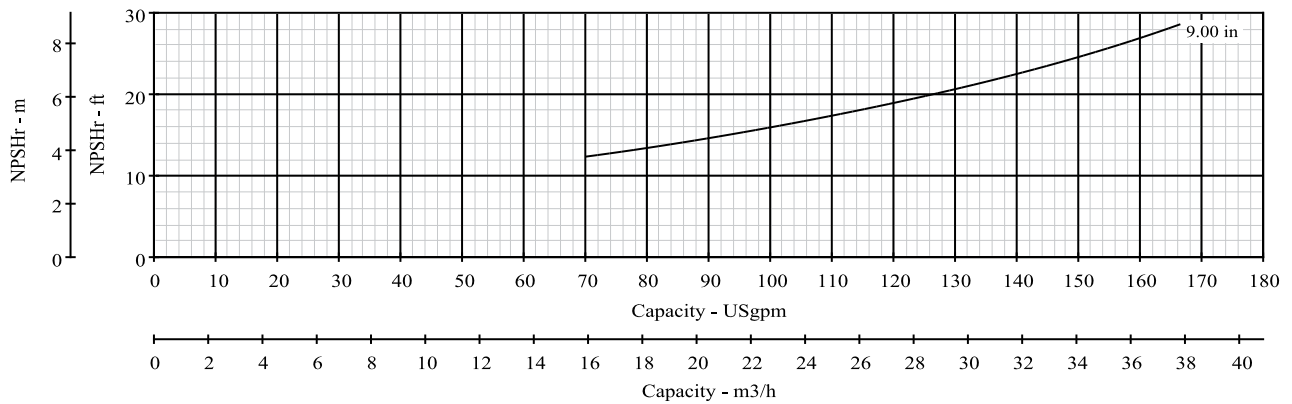
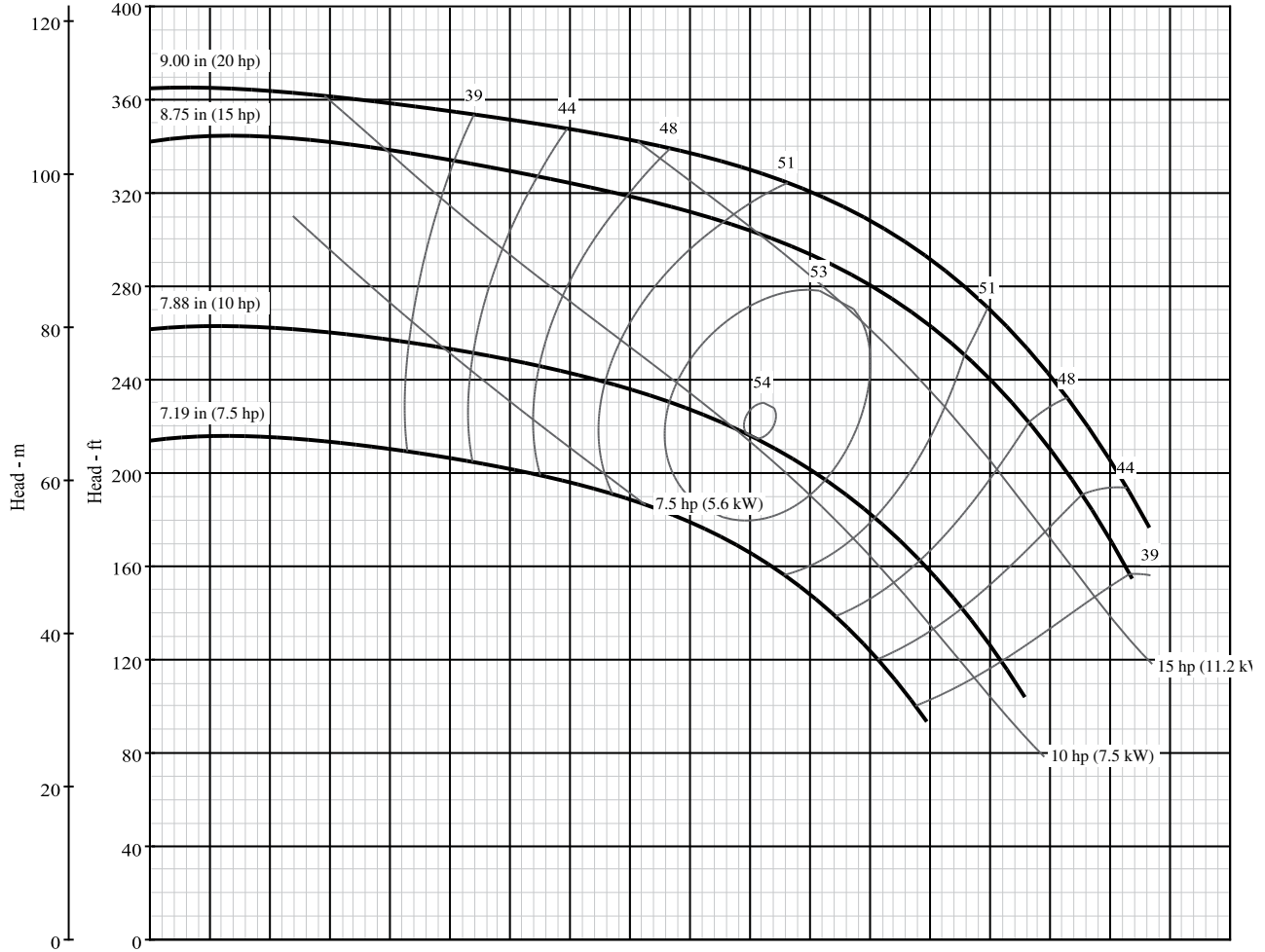

Pump Size: 1-1/2 x 2 x 9L

Model: B1-1/2Z_L

Curve No. 5036

Type	CCMD	FM CPLG	FM BELT	SAE	Hydraulic	AC Engine
Model	B1-1/2ZPL	B1-1/2ZRL	B1-1/2ZRL			
RPM	1801-3600	1000-3600	1000-3600			

Dia. 9.00"

Nominal RPM: **VARIOUS**
 Based on Fresh Water @ 68°F (20°C)
 Maximum Working Pressure: 250 PSI (17 BAR)

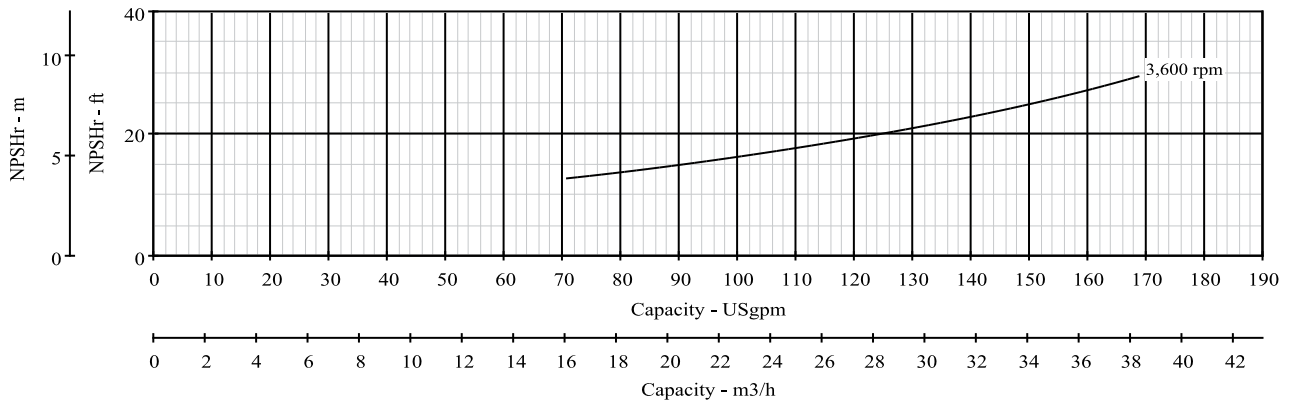
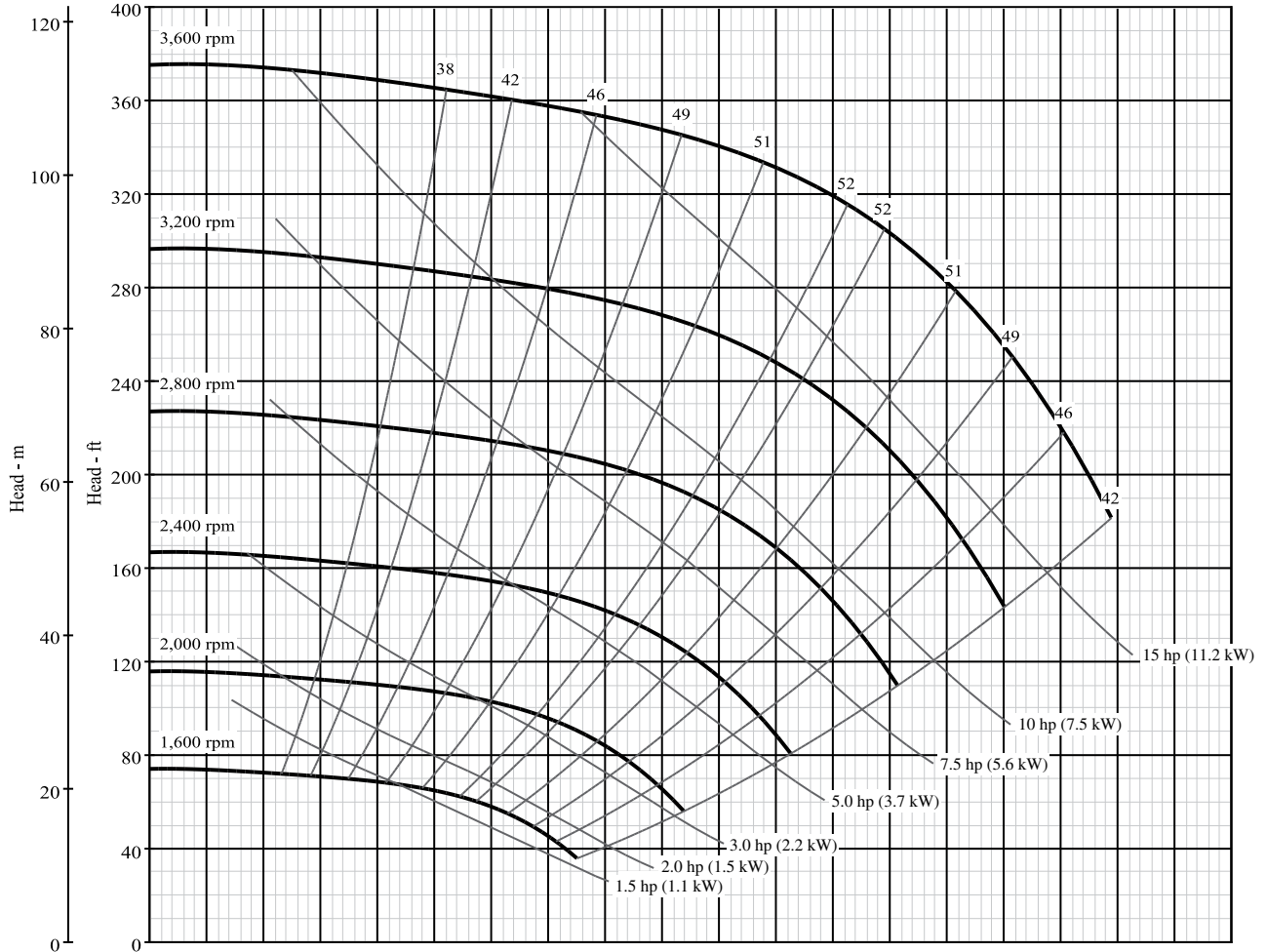

*NPSH data shown is at maximum speed

Pump Size: 1-1/2 x 2 x 9H

Model: B1-1/2Z_HS

Curve No. 9086

Type	CCMD	FM CPLG	FM BELT	SAE	Hydraulic	AC Engine
Model	B1-1/2ZPHS					

Nominal RPM: **3500**
 Based on Fresh Water @ **68°F (20°C)**
 Maximum Working Pressure: **266 PSI (18 BAR)**

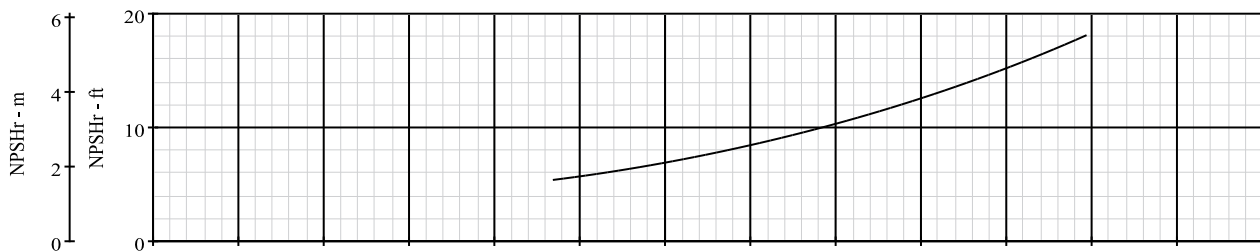
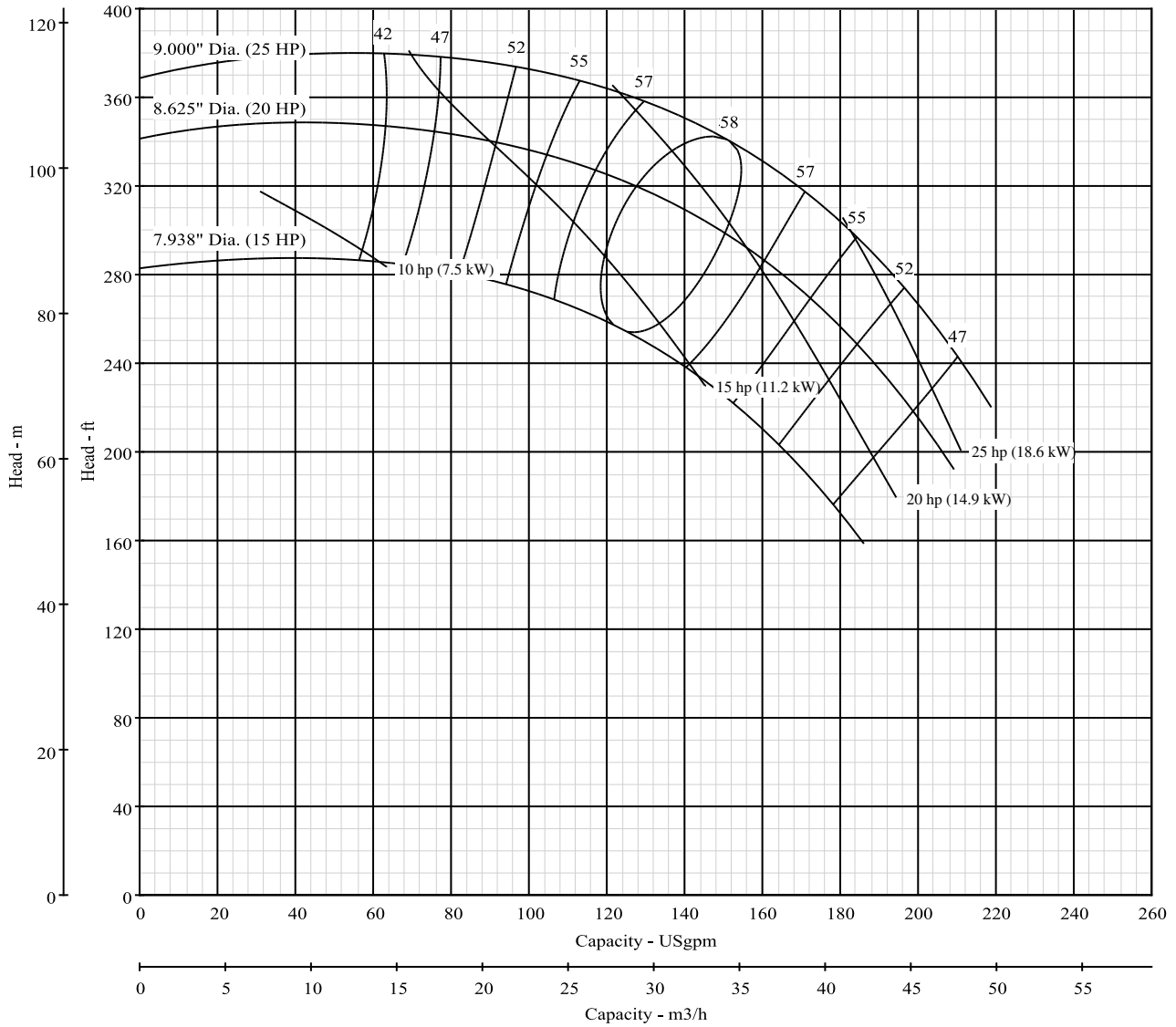

Pump Size: 1-1/2 x 2 x 9H

Model: B1-1/2Z_HS

Curve No. 9086

Type	CCMD	FM CPLG	FM BELT	SAE	Hydraulic	AC Engine
Model	B1-1/2ZPHS					
RPM	1201-3600					

Dia. 9.00"

Nominal RPM: **VARIOUS**
 Based on Fresh Water @ 68°F (20°C)
 Maximum Working Pressure: 266 PSI (18 BAR)

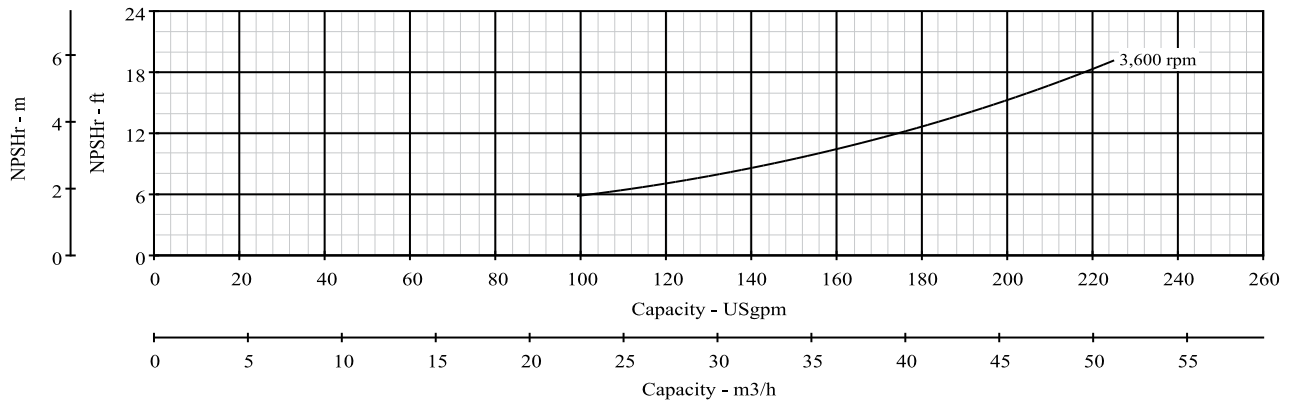
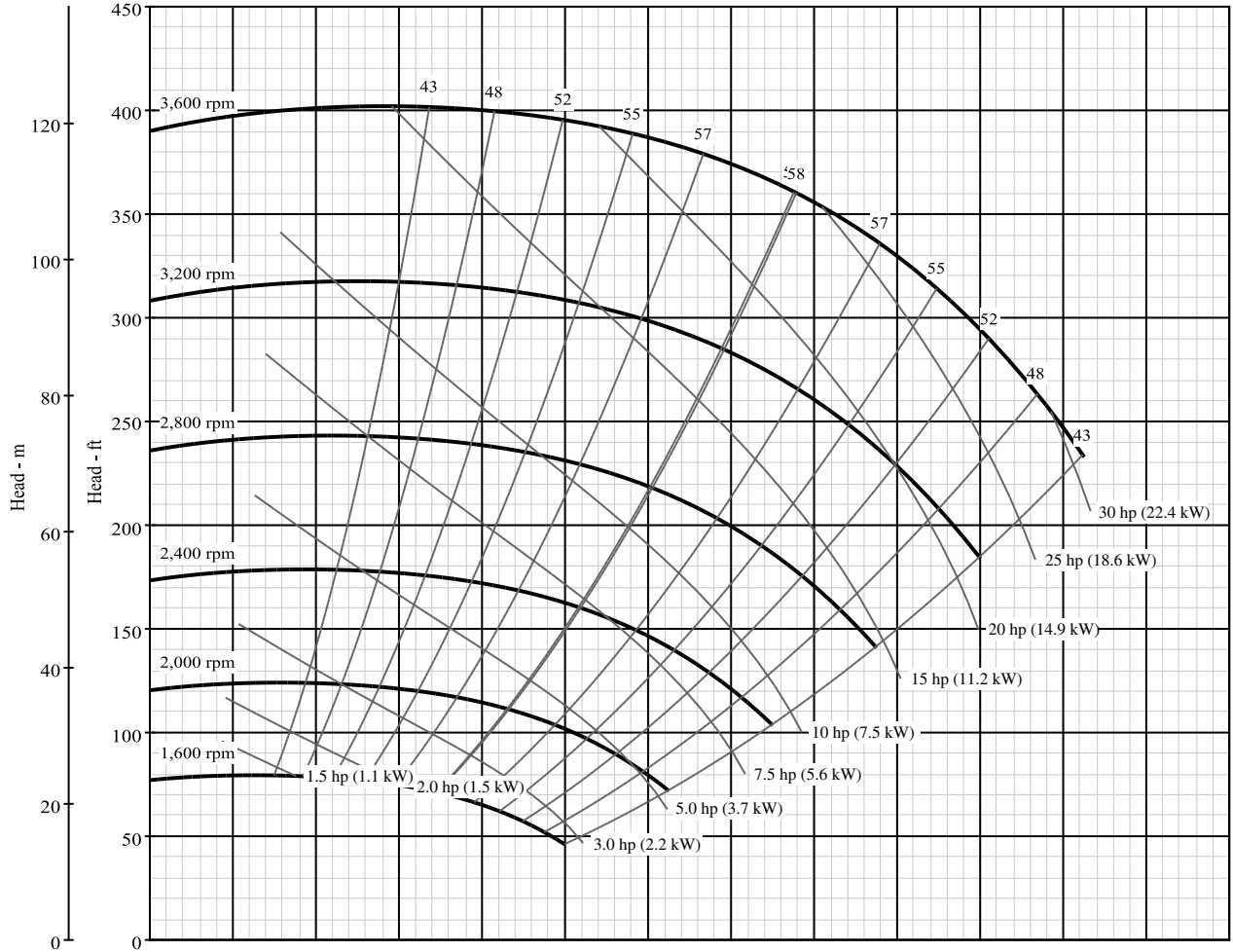

*NPSH data shown is at maximum speed

Pump Size: 2 x 2-1/2 x 9 L

Model: B2Z_L

Curve No. 8553

Type	CCMD	FM CPLG	FM BELT	SAE	Hydraulic	AC Engine
Model	B2ZPL	B2ZRL				B2ZQLS-18 (7.88" Diameter Impeller)

Nominal RPM: **3500**
 Based on Fresh Water @ **68°F (20°C)**
 Maximum Working Pressure: **250 PSI (17 BAR)**

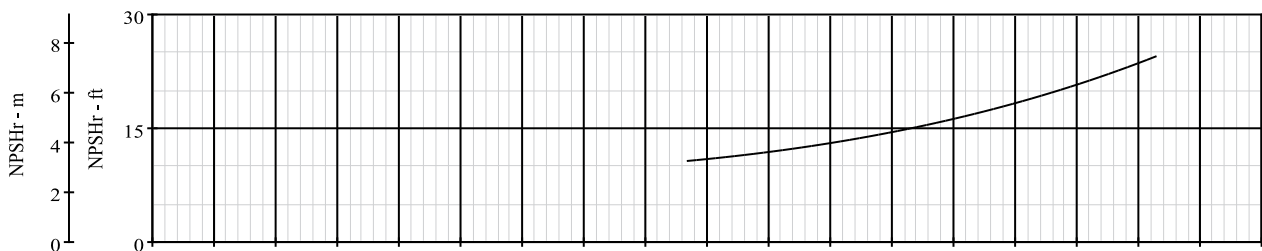
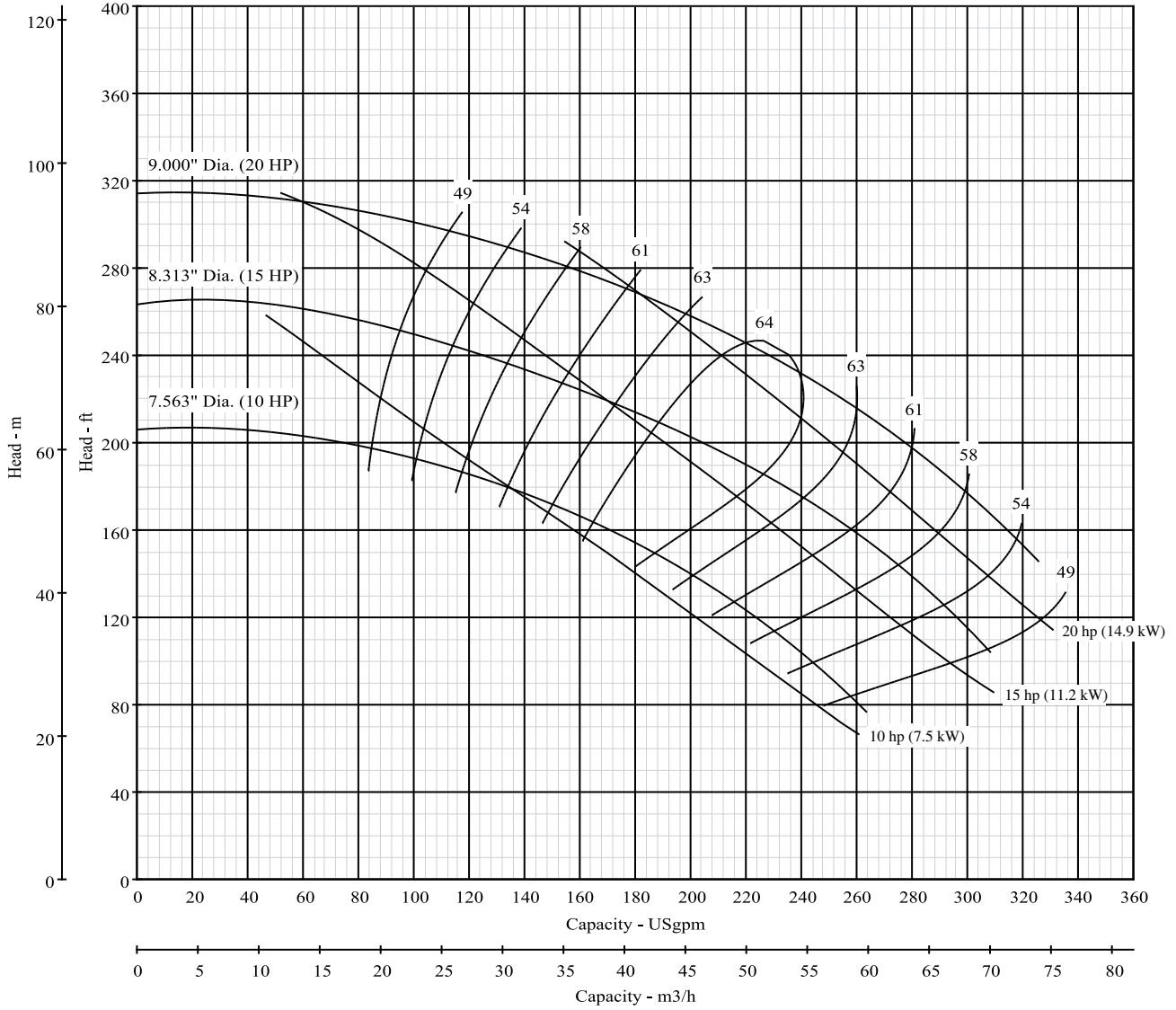

Pump Size: 2 x 2-1/2 x 9 L

Model: B2Z_L

Curve No. 8553

Type	CCMD	FM CPLG	FM BELT	SAE	Hydraulic	AC Engine
Model	B2ZPL	B2ZRL				
RPM	1801-3600	1000-3600				

Dia. 9.00"

Nominal RPM: **VARIOUS**
 Based on Fresh Water @ 68°F (20°C)
 Maximum Working Pressure: 250 PSI (17 BAR)

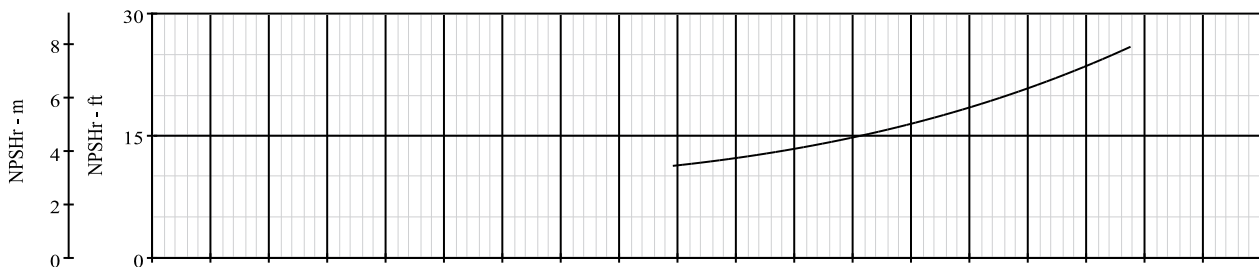
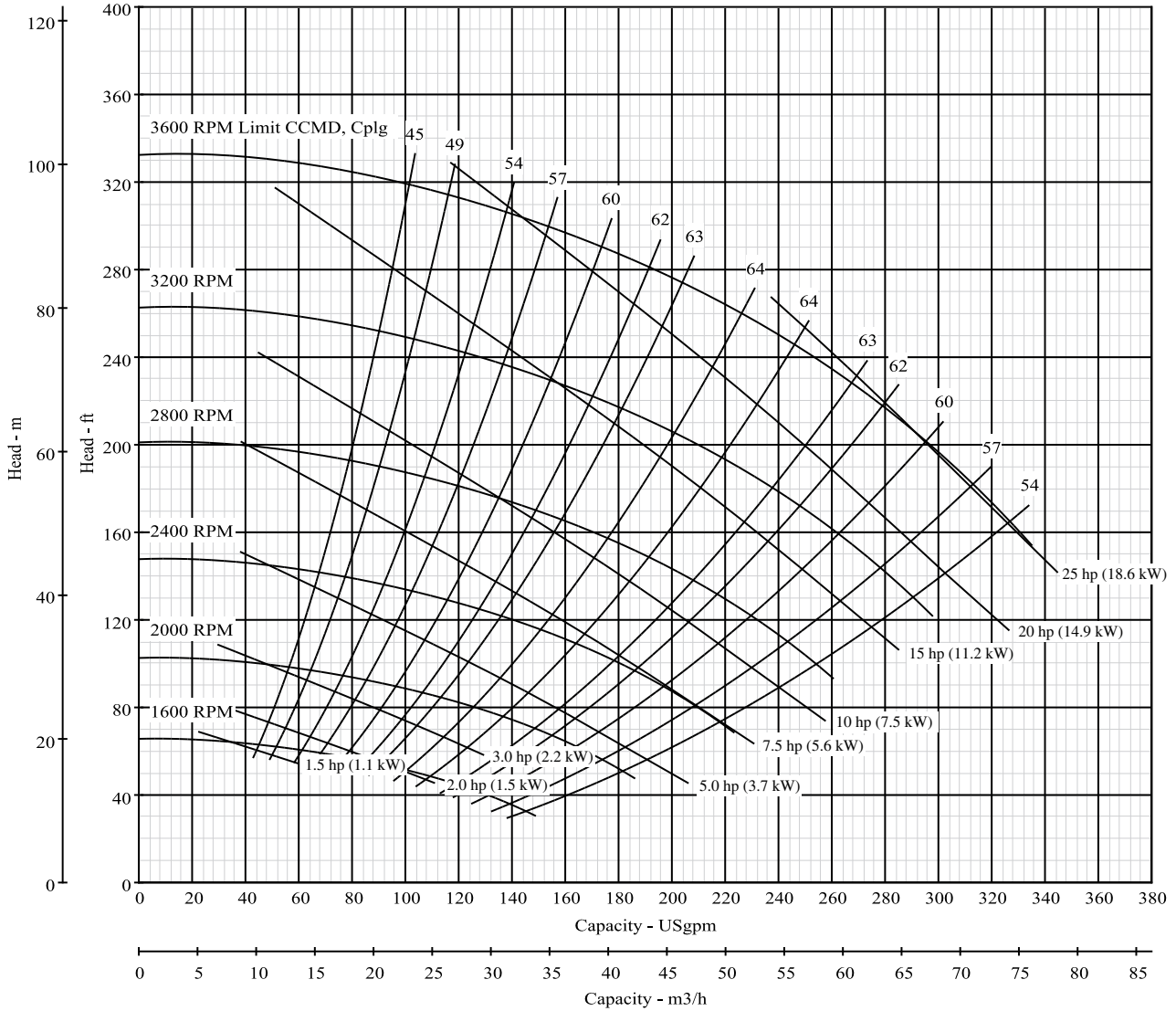

*NPSH data shown is at maximum speed

Pump Size: 2 x 2-1/2 x 9 M

Model: B2Z_M

Curve No. 2070

Type	CCMD	FM CPLG	FM BELT	SAE	Hydraulic	AC Engine
Model		B2ZRM	B2ZRM	B2ZQM		
RPM		1000-2800	1000-2800	1800-3200		

Dia. 9.00"

Nominal RPM: **VARIOUS**
 Based on Fresh Water @ 68°F (20°C)
 Maximum Working Pressure: 266 PSI (18 BAR)

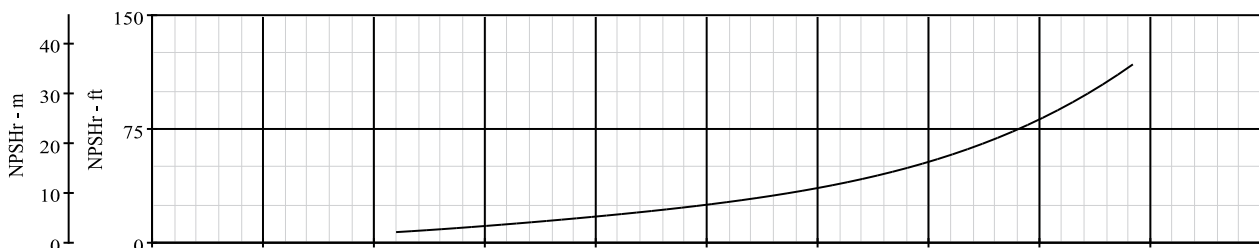
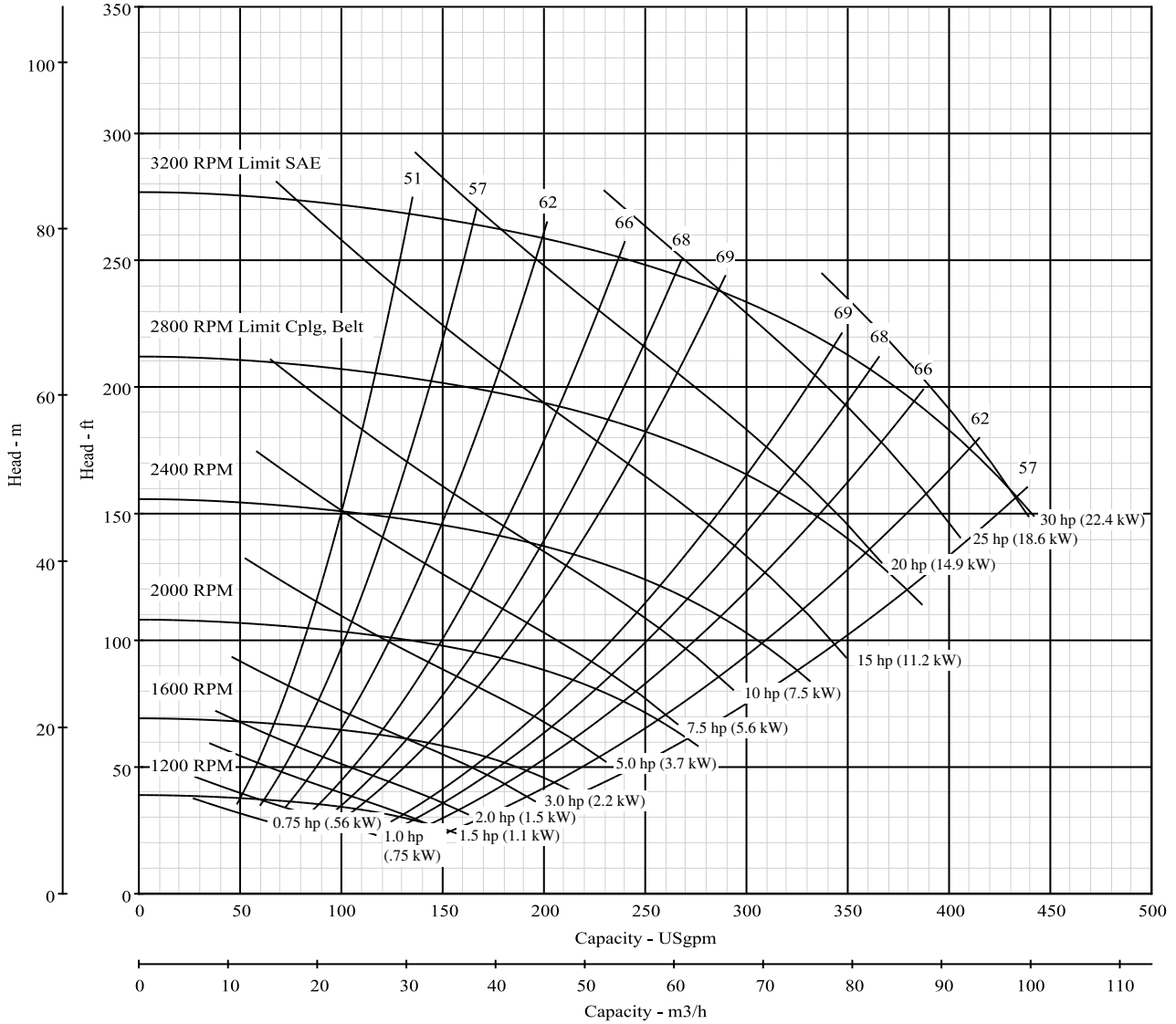

*NPSH data shown is at maximum speed

Pump Size: 2 x 2-1/2 x 9 H

Model: B2Z_H

Curve No. 8940

Type	CCMD	FM CPLG	FM BELT	SAE	Hydraulic	AC Engine
Model	B2ZPH					

Nominal RPM: **3500**
 Based on Fresh Water @ **68°F (20°C)**
 Maximum Working Pressure: **266 PSI (18 BAR)**

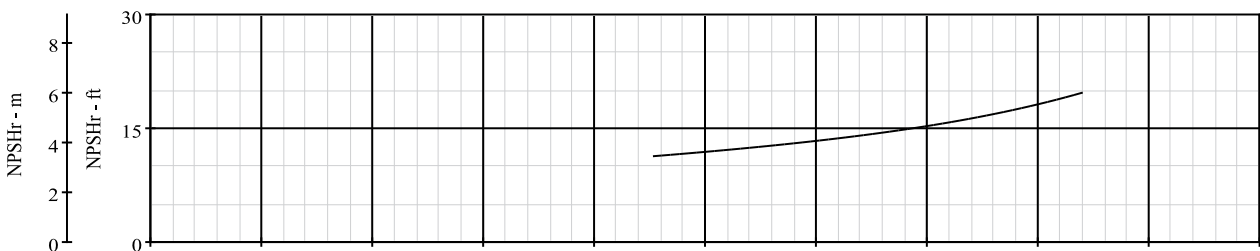
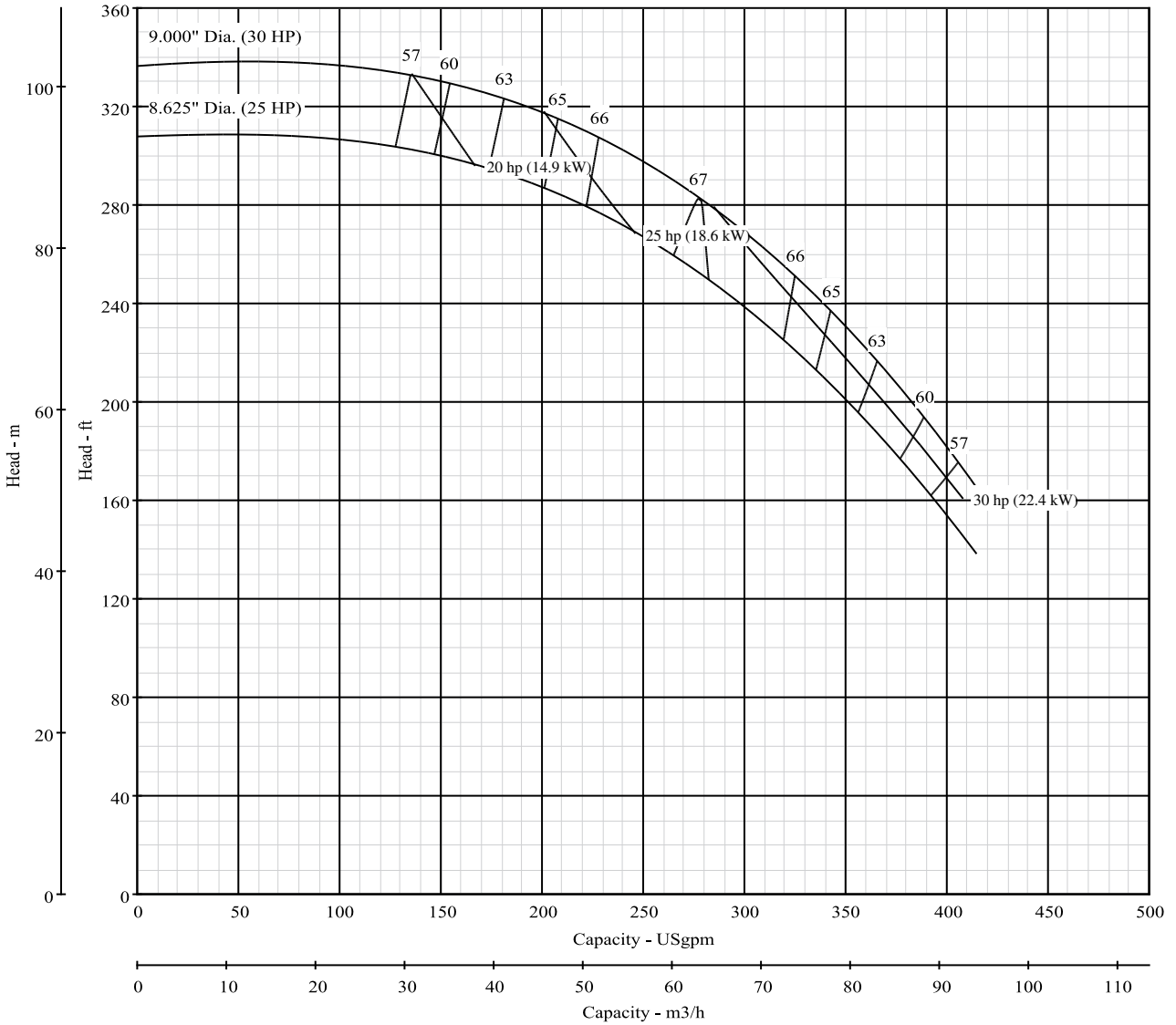

Pump Size: 2 x 2-1/2 x 9 H

Model: B2Z_H

Curve No. 8940

Type	CCMD	FM CPLG	FM BELT	SAE	Hydraulic	AC Engine
Model	B2ZPH					
RPM	1801-3600					

Dia. 9.00"

Nominal RPM: **VARIOUS**
 Based on Fresh Water @ 68°F (20°C)
 Maximum Working Pressure: 266 PSI (18 BAR)

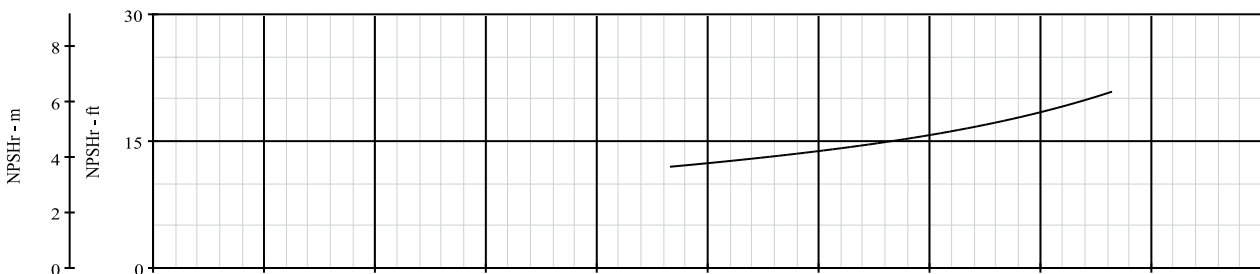
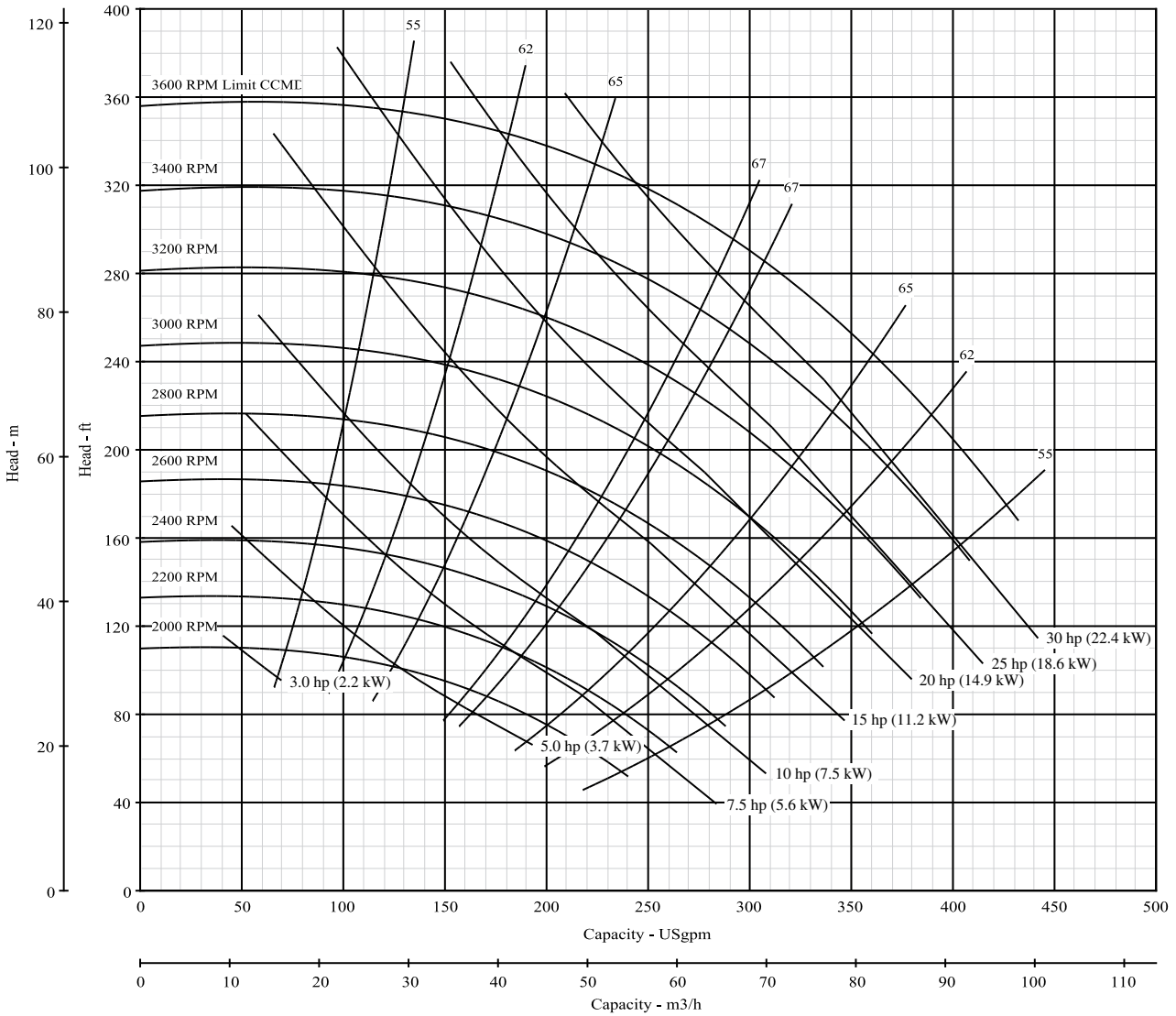

*NPSH data shown is at maximum speed

Pump Size: 2-1/2 x 3 x 9 L

Model: B2-1/2Z_L

Curve No. 5040

Type	CCMD	FM CPLG	FM BELT	SAE	Hydraulic	AC Engine
Model	B2-1/2ZPL	B2-1/2ZRL				

Nominal RPM: **3500**
 Based on Fresh Water @ **68°F (20°C)**
 Maximum Working Pressure: 250 PSI (17 BAR)

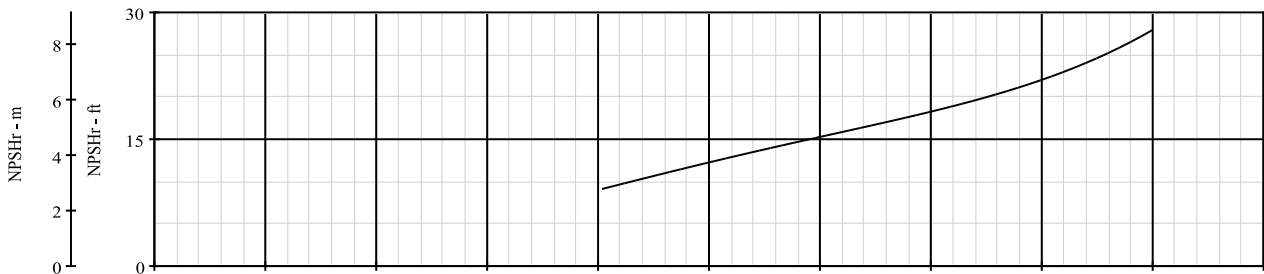
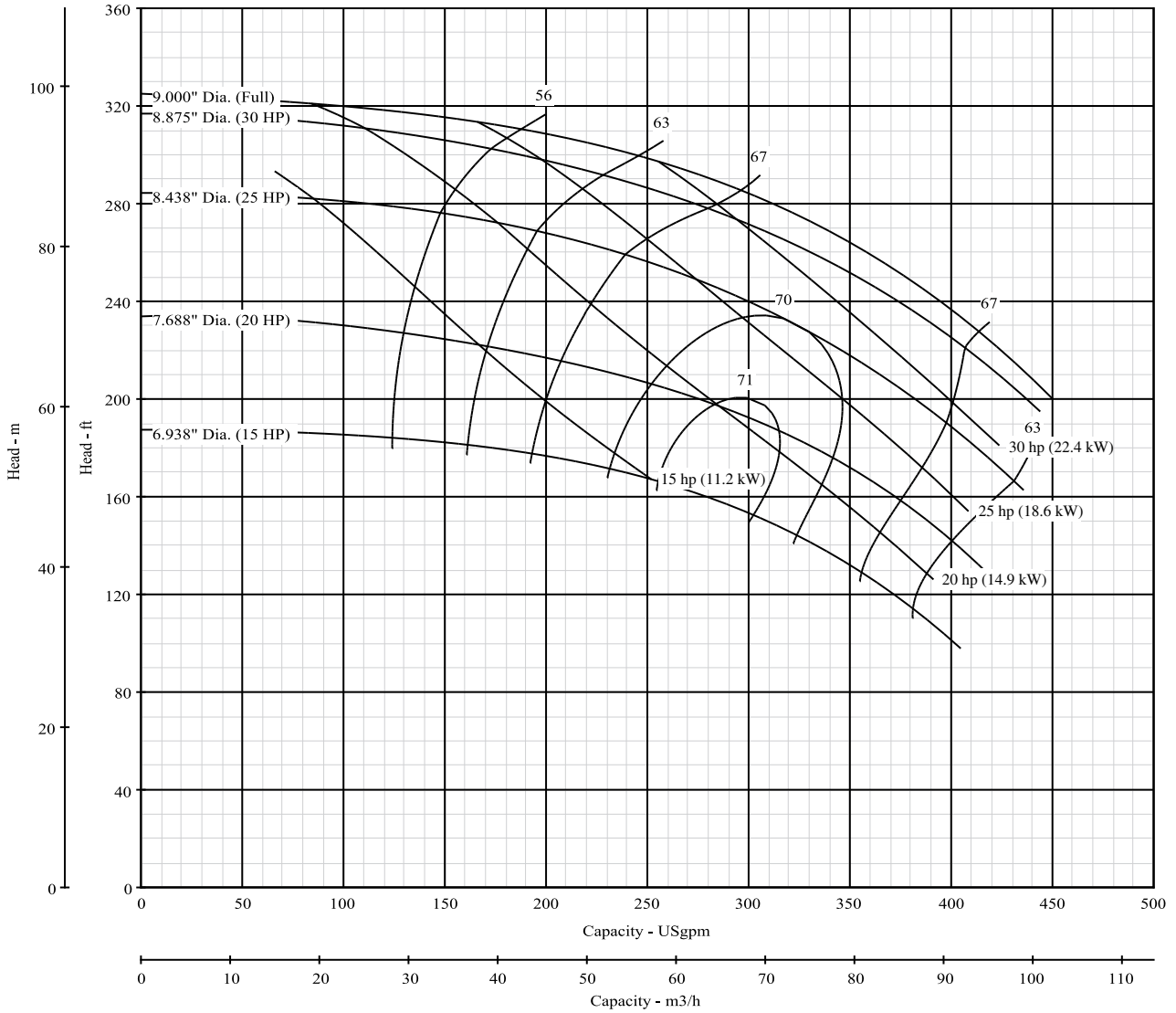

Pump Size: 2-1/2 x 3 x 9 L

Model: B2-1/2Z_L

Curve No. 5040

Type	CCMD	FM CPLG	FM BELT	SAE	Hydraulic	AC Engine
Model	B2-1/2ZPL	B2-1/2ZRL	B2-1/2ZRL			
RPM	1801-3600	1400-3400	1400-2700			

Dia. 9.00"

Nominal RPM: **VARIOUS**
 Based on Fresh Water @ 68°F (20°C)
 Maximum Working Pressure: 250 PSI (17 BAR)

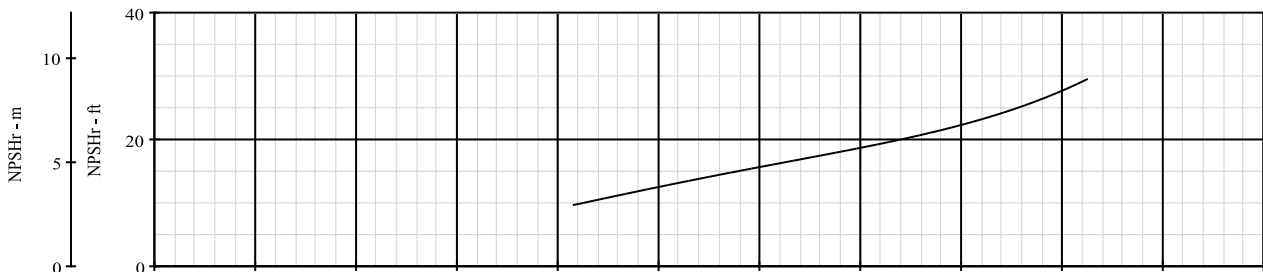
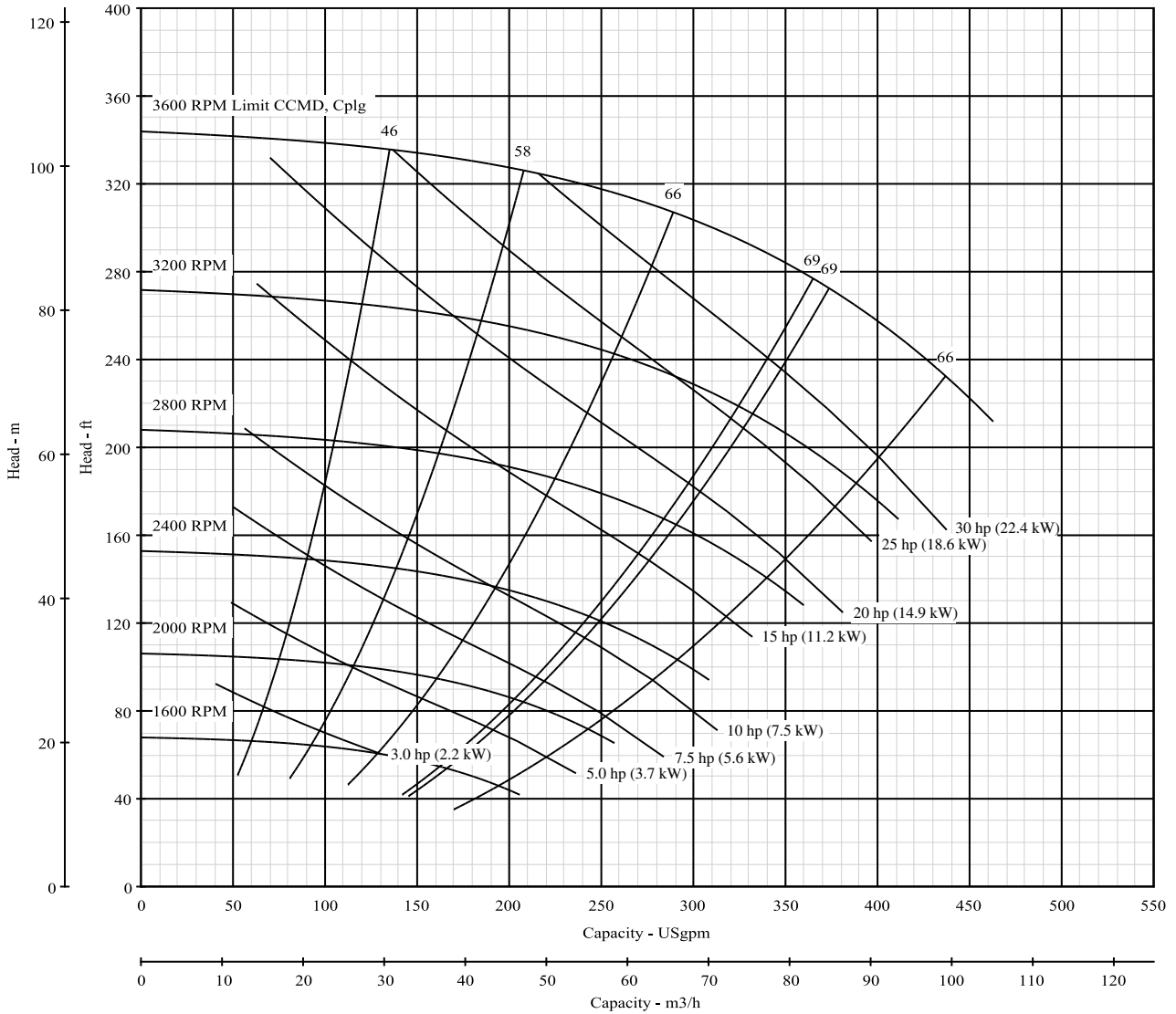

*NPSH data shown is at maximum speed

Pump Size: 2-1/2 x 3 x 9 M

Model: B2-1/2Z_M

Curve No. 5020

Type	CCMD	FM CPLG	FM BELT	SAE	Hydraulic	AC Engine
Model	B2-1/2ZPM	B2-1/2ZRM	B2-1/2ZRM	B2-1/2ZQM		

Nominal RPM: **1740**
 Based on Fresh Water @ **68°F (20°C)**
 Maximum Working Pressure: 266 PSI (18 BAR)

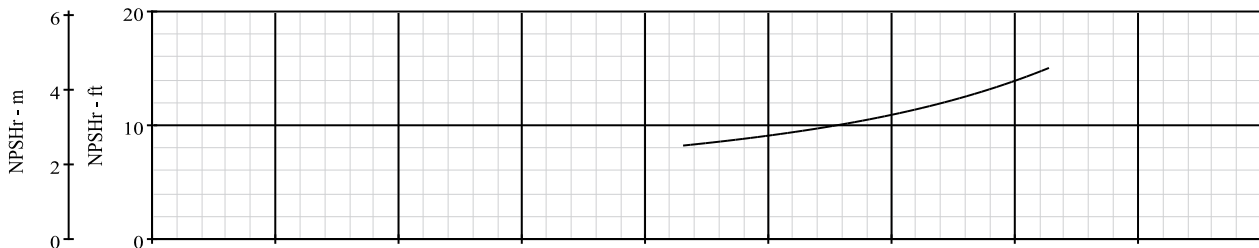
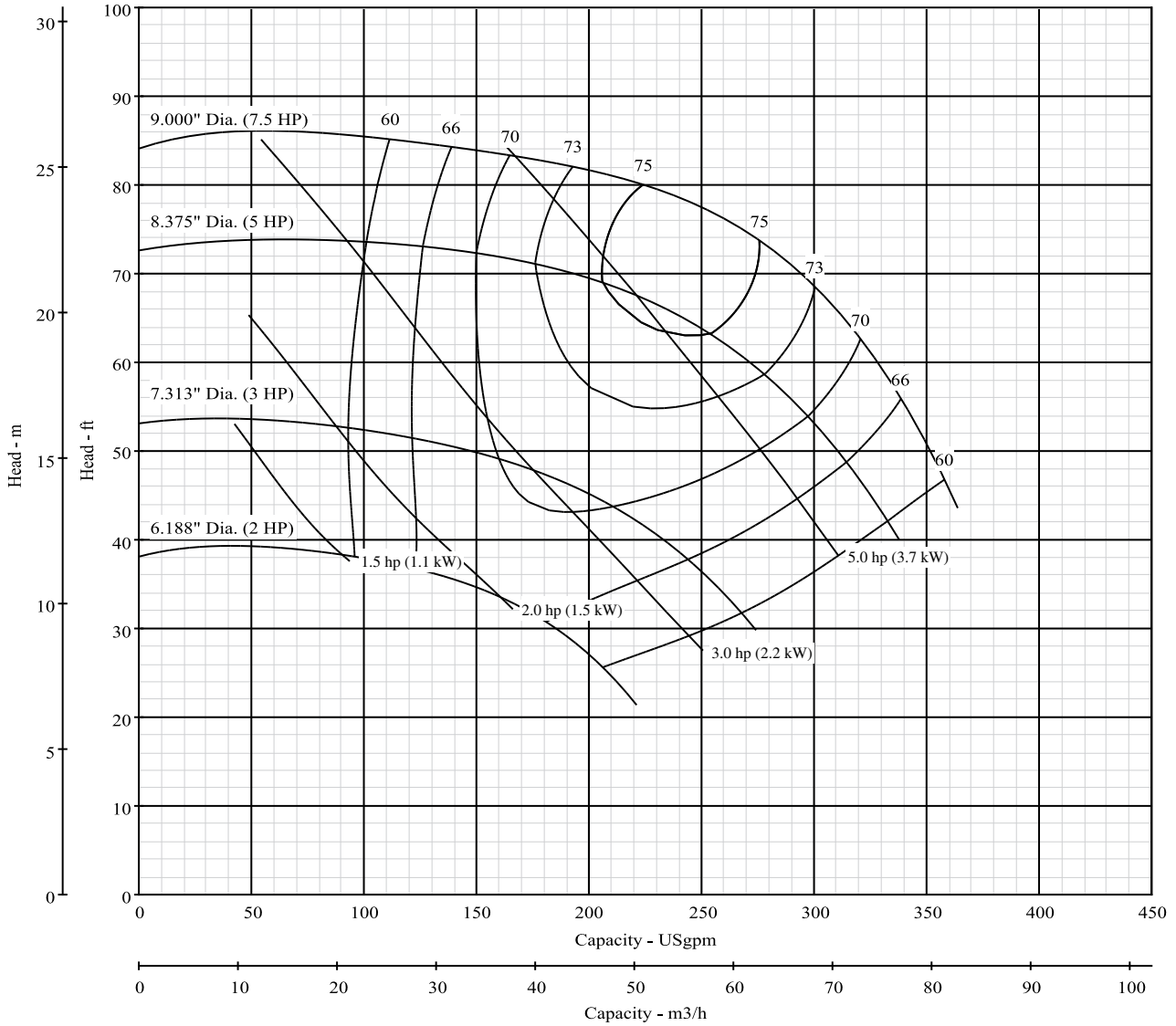

Pump Size: 2-1/2 x 3 x 9 M

Model: B2-1/2Z_M

Curve No. 5020

Type	CCMD	FM CPLG	FM BELT	SAE	Hydraulic	AC Engine
Model	B2-1/2ZPM	B2-1/2ZRM	B2-1/2ZRM	B2-1/2ZQM		
RPM	1201-1800	1400-3400	1400-2700	1800-2600		

Dia. 9.00" Nominal RPM: **VARIOUS**
Based on Fresh Water @ 68°F (20°C)
Maximum Working Pressure: 266 PSI (18 BAR)

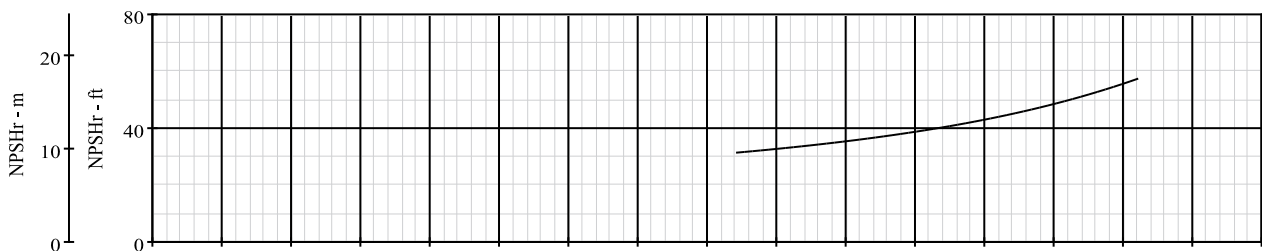
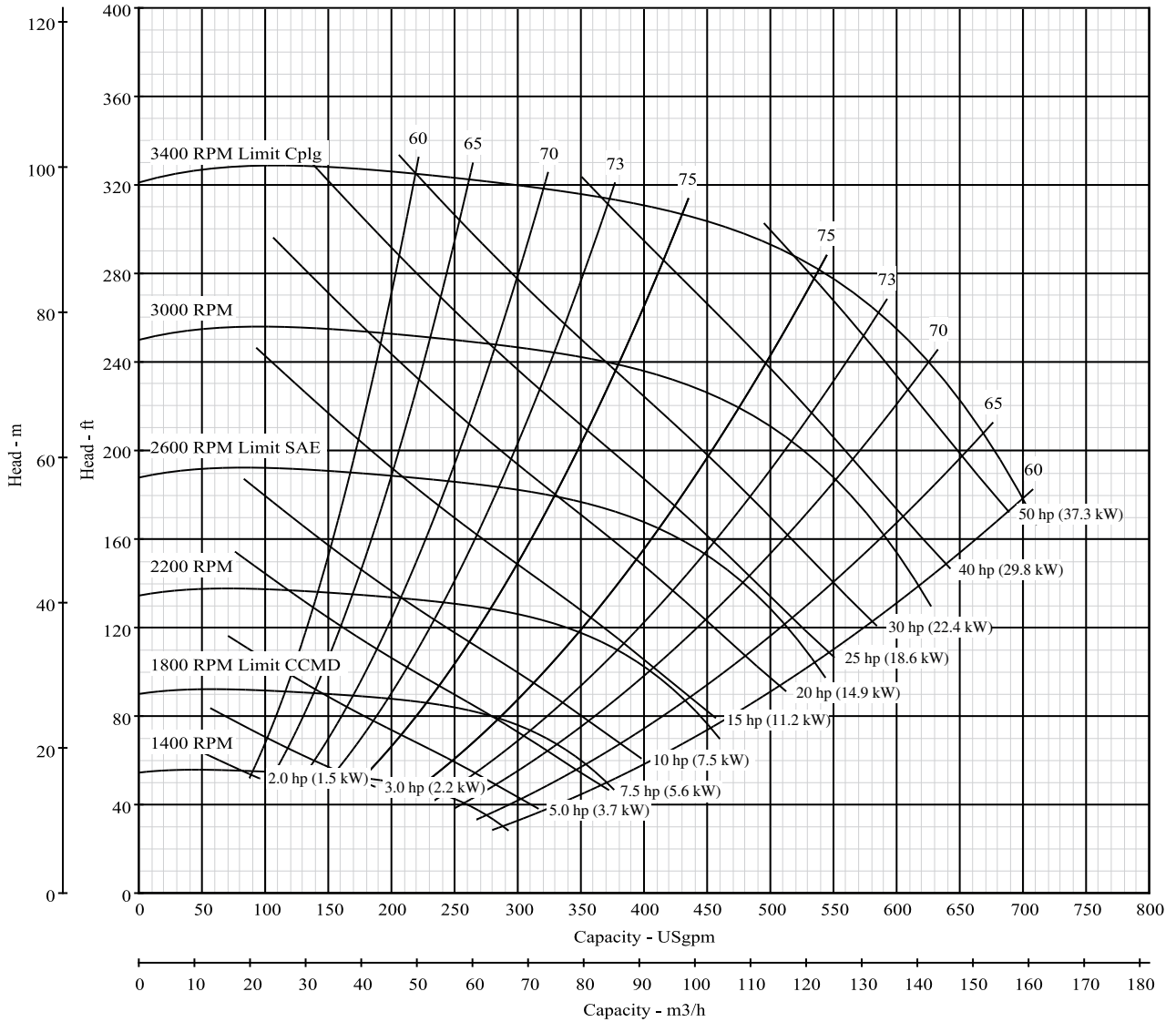

*NPSH data shown is at maximum speed

Pump Size: 3 x 4 x 9 L

Model: B3Z_L

Curve No. 5006

Type	CCMD	FM CPLG	FM BELT	SAE	Hydraulic	AC Engine
Model	B3ZPL					

Nominal RPM: **3550**
 Based on Fresh Water @ **68°F (20°C)**
 Maximum Working Pressure: **266 PSI (18 BAR)**

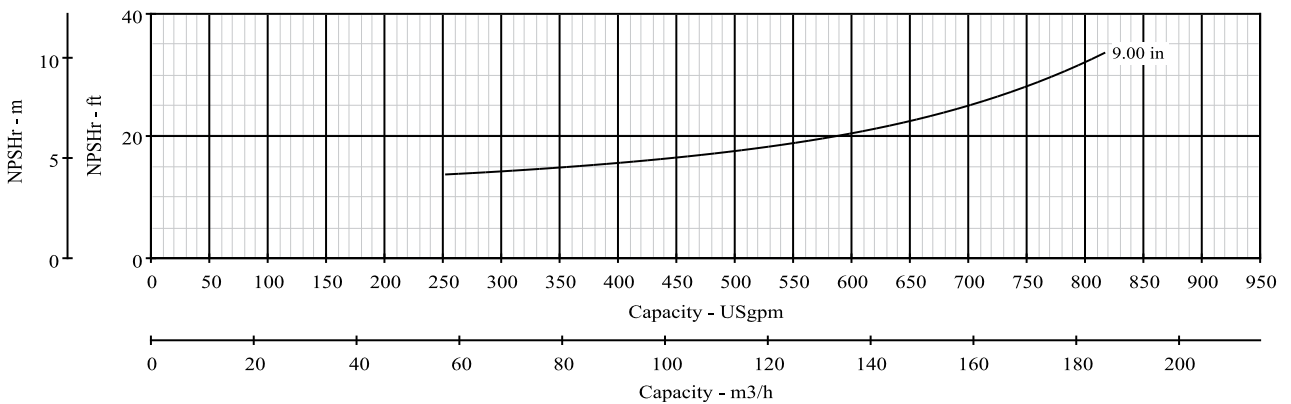
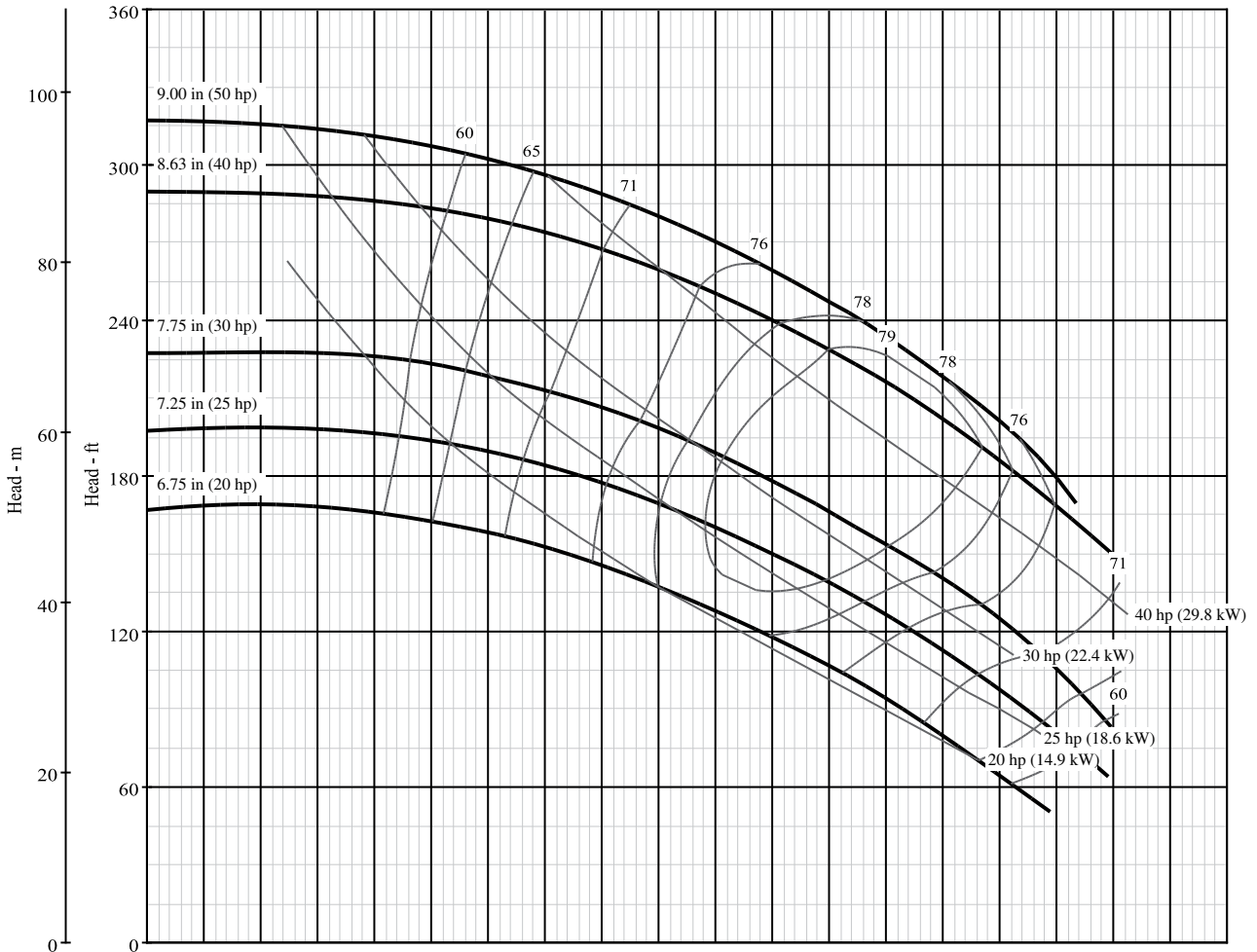

Pump Size: 3 x 4 x 9 L

Model: B3Z_L

Curve No. 5006

Type	CCMD	FM CPLG	FM BELT	SAE	Hydraulic	AC Engine
Model	B3ZPL					
RPM	1201-3600					

Dia. 9.00" Nominal RPM: **VARIOUS**
Based on Fresh Water @ 68°F (20°C)
Maximum Working Pressure: 266 PSI (18 BAR)

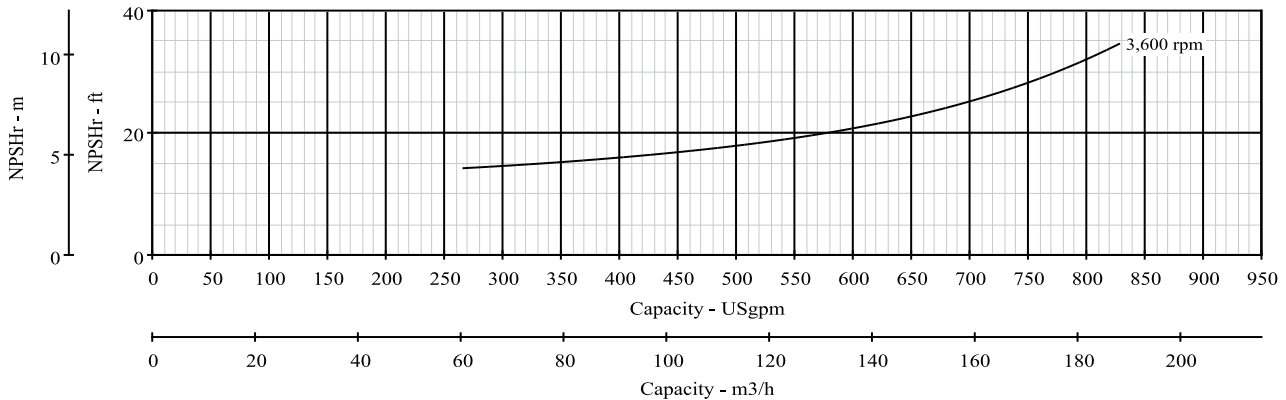
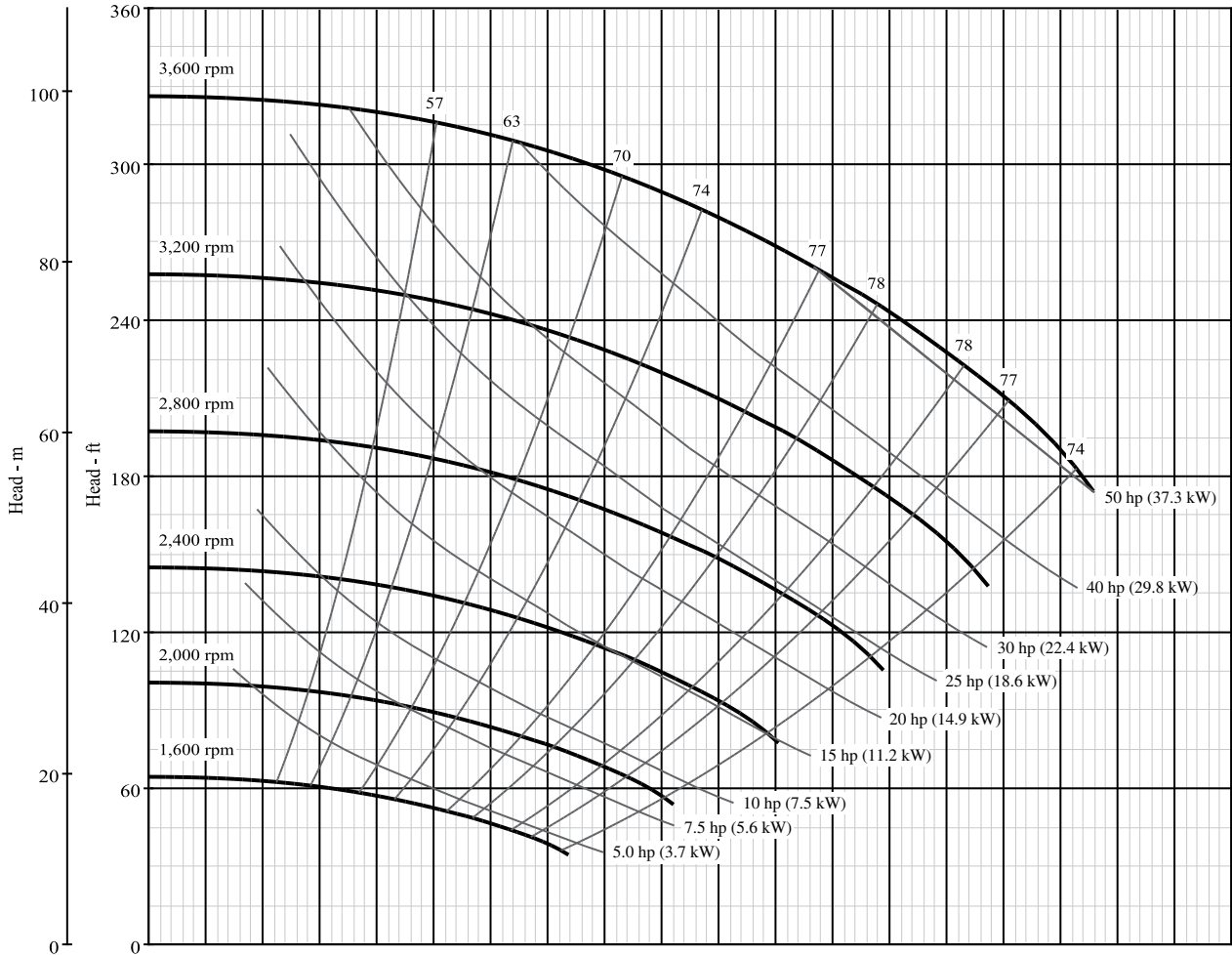

*NPSH data shown is at maximum speed

Pump Size: 3 x 4 x 9 M

Model: B3Z_M

Curve No. 5021

Type	CCMD	FM CPLG	FM BELT	SAE	Hydraulic	AC Engine
Model	B3ZPM	B3ZRM	B3ZRM	B3ZQM	B3ZRM-HYD	

Nominal RPM: **1750**
 Based on Fresh Water @ **68°F (20°C)**
 Maximum Working Pressure: **266 PSI (18 BAR)**

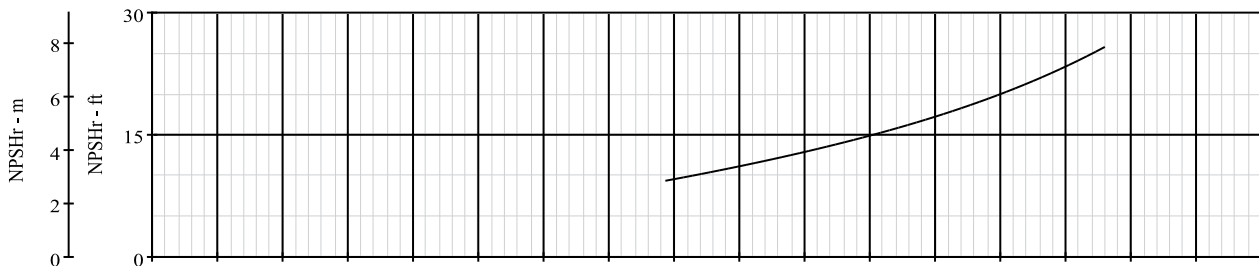
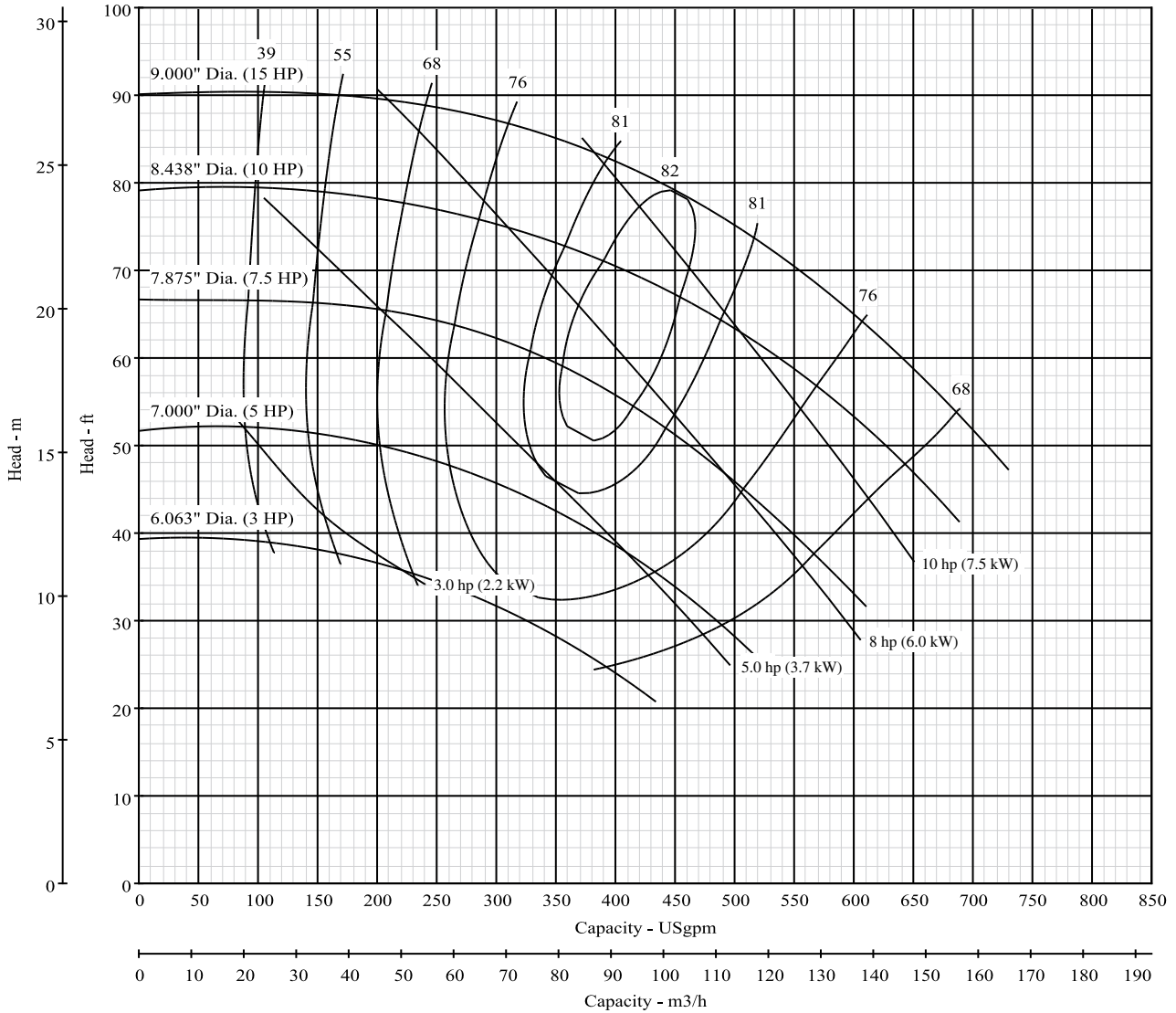

Pump Size: 3 x 4 x 9 M

Model: B3Z_M

Curve No. 5021

Type	CCMD	FM CPLG	FM BELT	SAE	Hydraulic	AC Engine
Model	B3ZPM	B3ZRM	B3ZRM	B3ZQM	B3ZRM-HYD	
RPM	1201-1800	1400-2500	1400-2300	1600-2500	1400-2500	

Dia. 9.00" Nominal RPM: **VARIOUS**
Based on Fresh Water @ 68°F (20°C)
Maximum Working Pressure: 266 PSI (18 BAR)

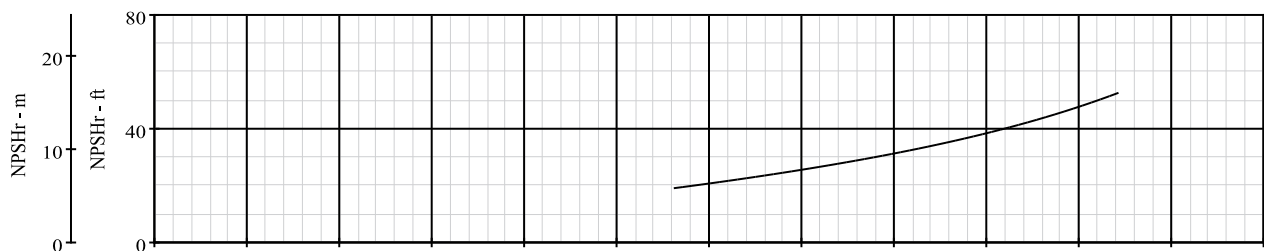
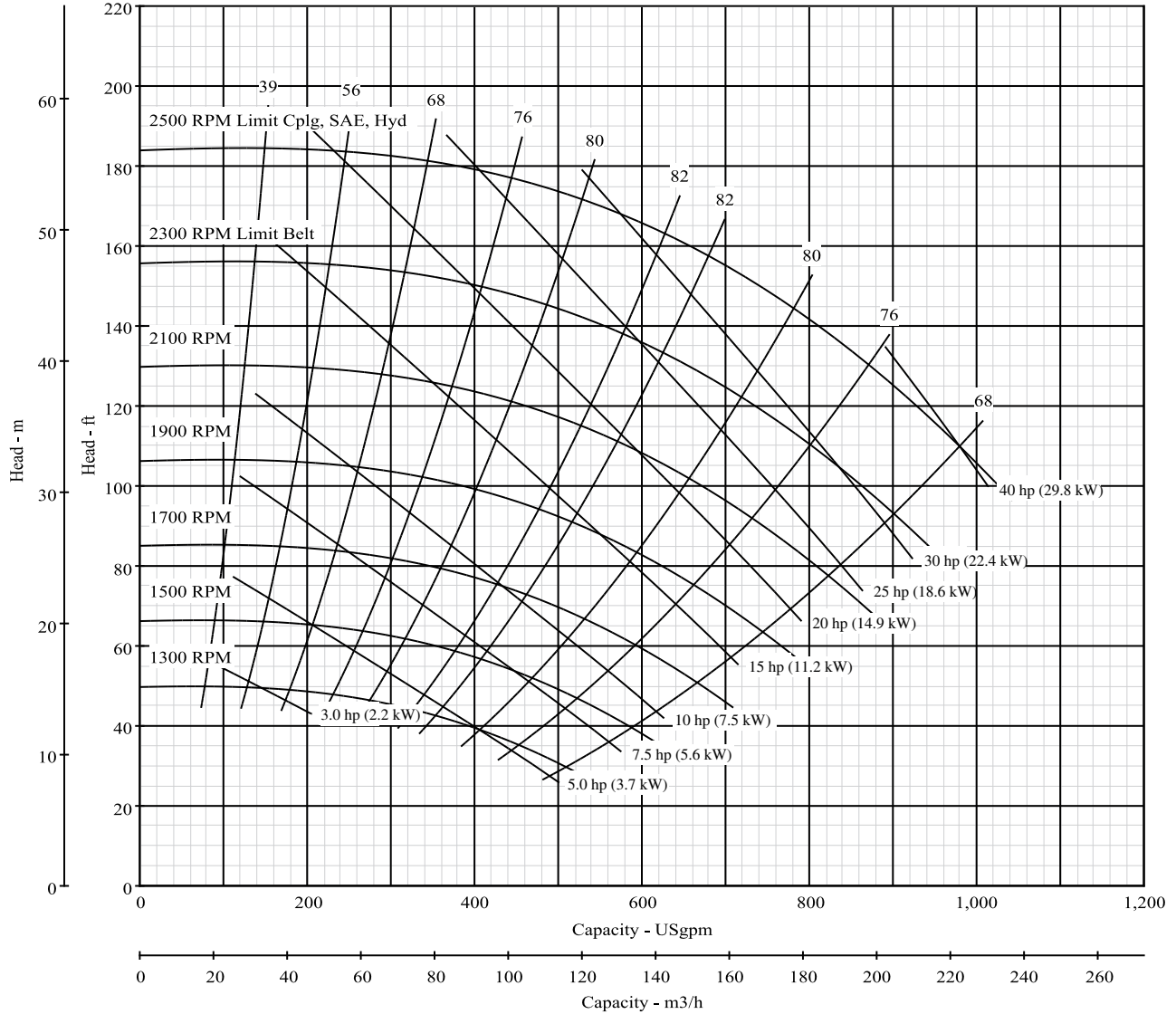

*NPSH data shown is at maximum speed

Pump Size: 3 x 4 x 9 BH

Model: B3Z_BH

Curve No. 8512

Type	CCMD	FM CPLG	FM BELT	SAE	Hydraulic	AC Engine
Model	B3ZPBH					

Nominal RPM: **3550**
 Based on Fresh Water @ **68°F (20°C)**
 Maximum Working Pressure: **266 PSI (18 BAR)**

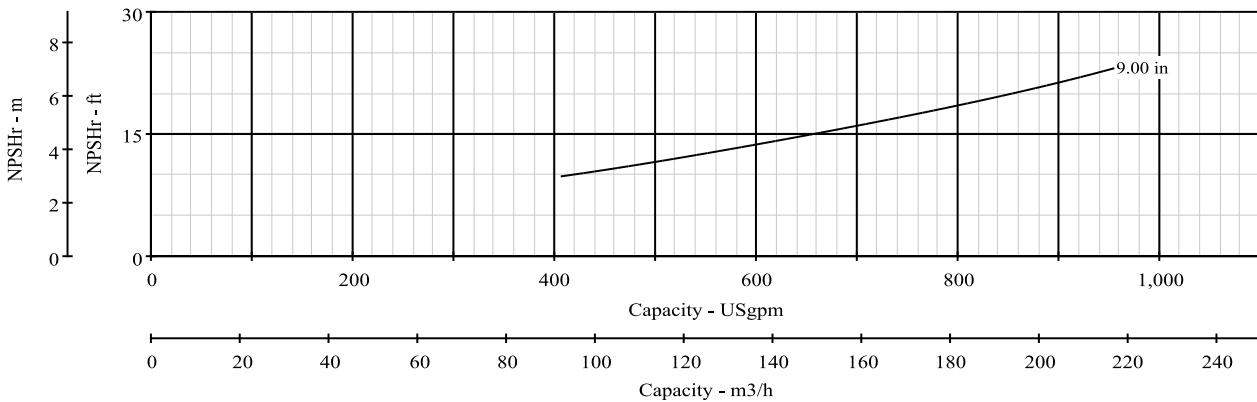
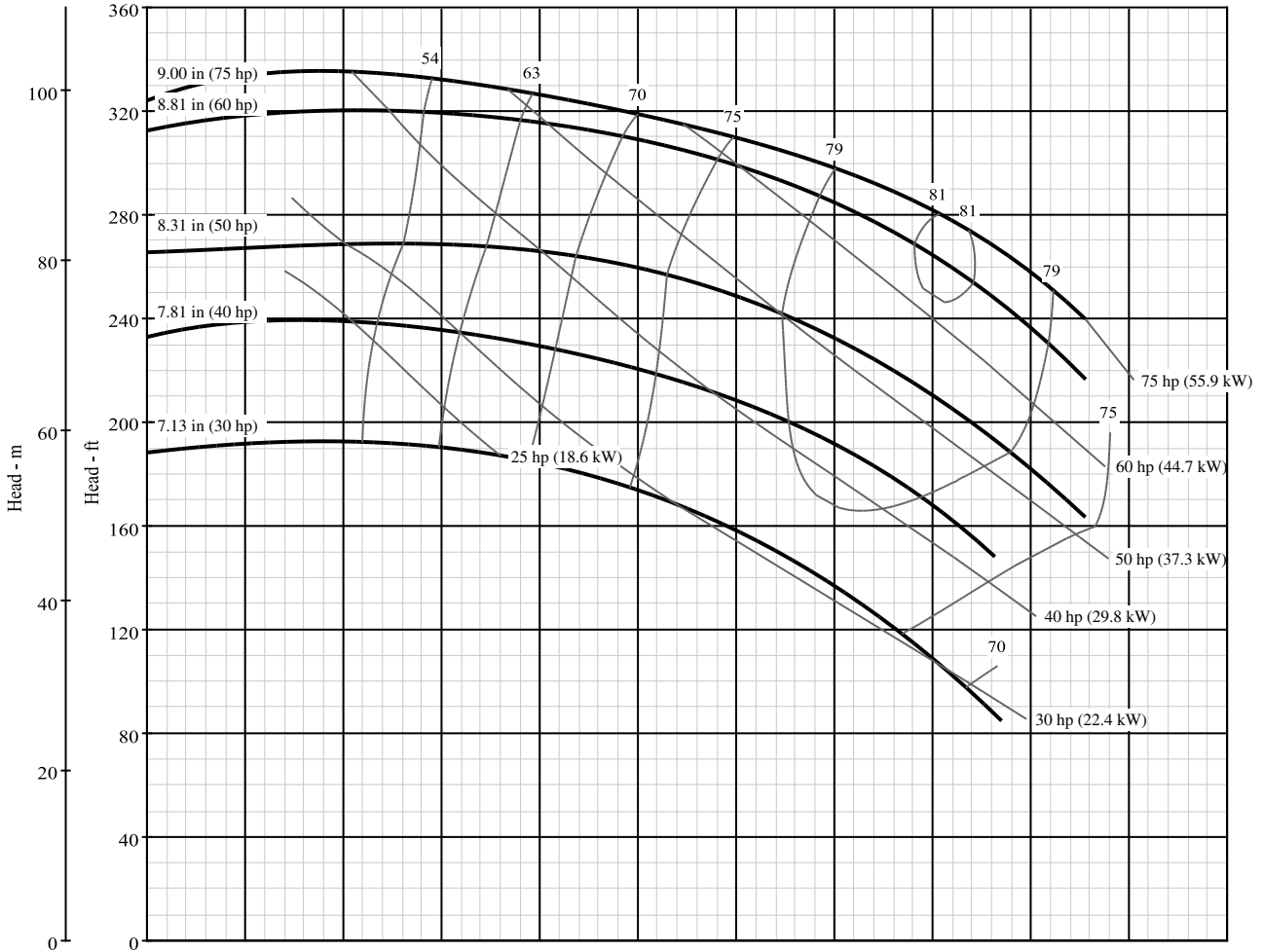

Pump Size: 3 x 4 x 9 BH

Model: B3Z_BH

Curve No. 8512

Type	CCMD	FM CPLG	FM BELT	SAE	Hydraulic	AC Engine
Model	B3ZPBH					
RPM	1801-3600					

Dia. 9.00"

Nominal RPM: **VARIOUS**
 Based on Fresh Water @ 68°F (20°C)
 Maximum Working Pressure: 266 PSI (18 BAR)

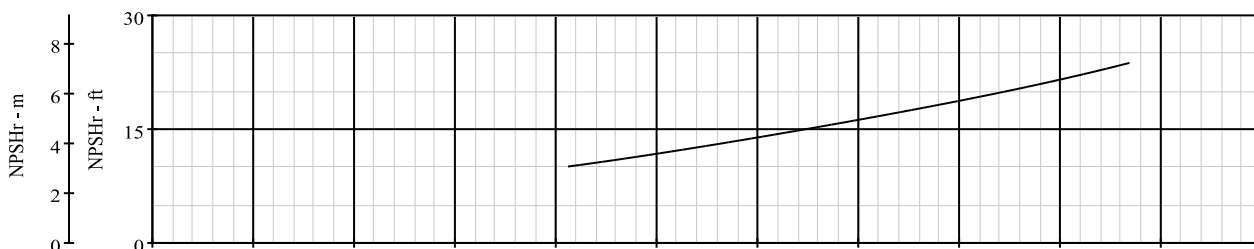
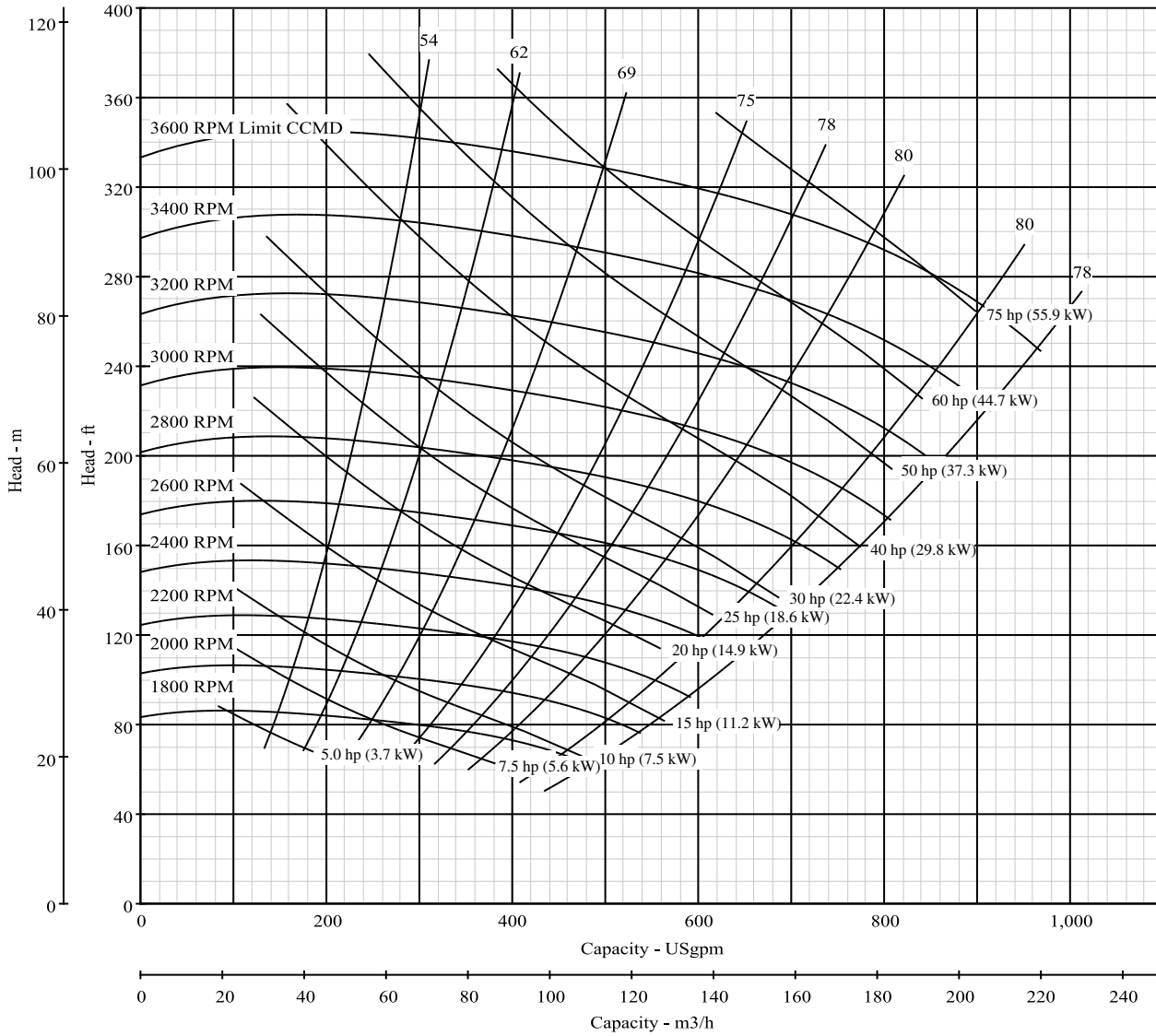

*NPSH data shown is at maximum speed

Pump Size: 4 x 5 x 9 BH

Model: B4Z_BH

Curve No.

Type	CCMD	FM CPLG	FM BELT	SAE	Hydraulic	AC Engine
Model	B4ZPBH	B4ZRBH	B4ZRBH	B4ZQBH		

Nominal RPM: **1750**
 Based on Fresh Water @ **68°F (20°C)**
 Maximum Working Pressure: **175 PSI (12 BAR)**

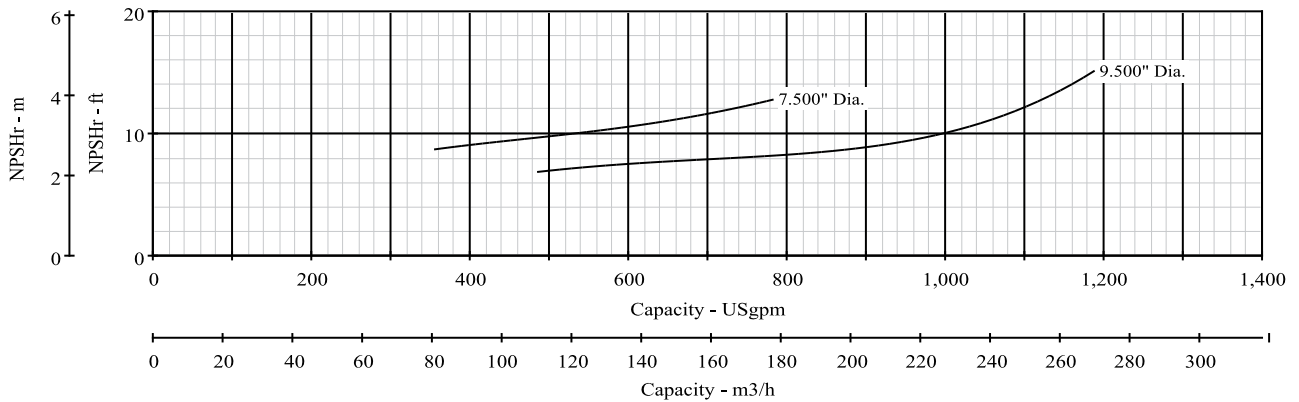
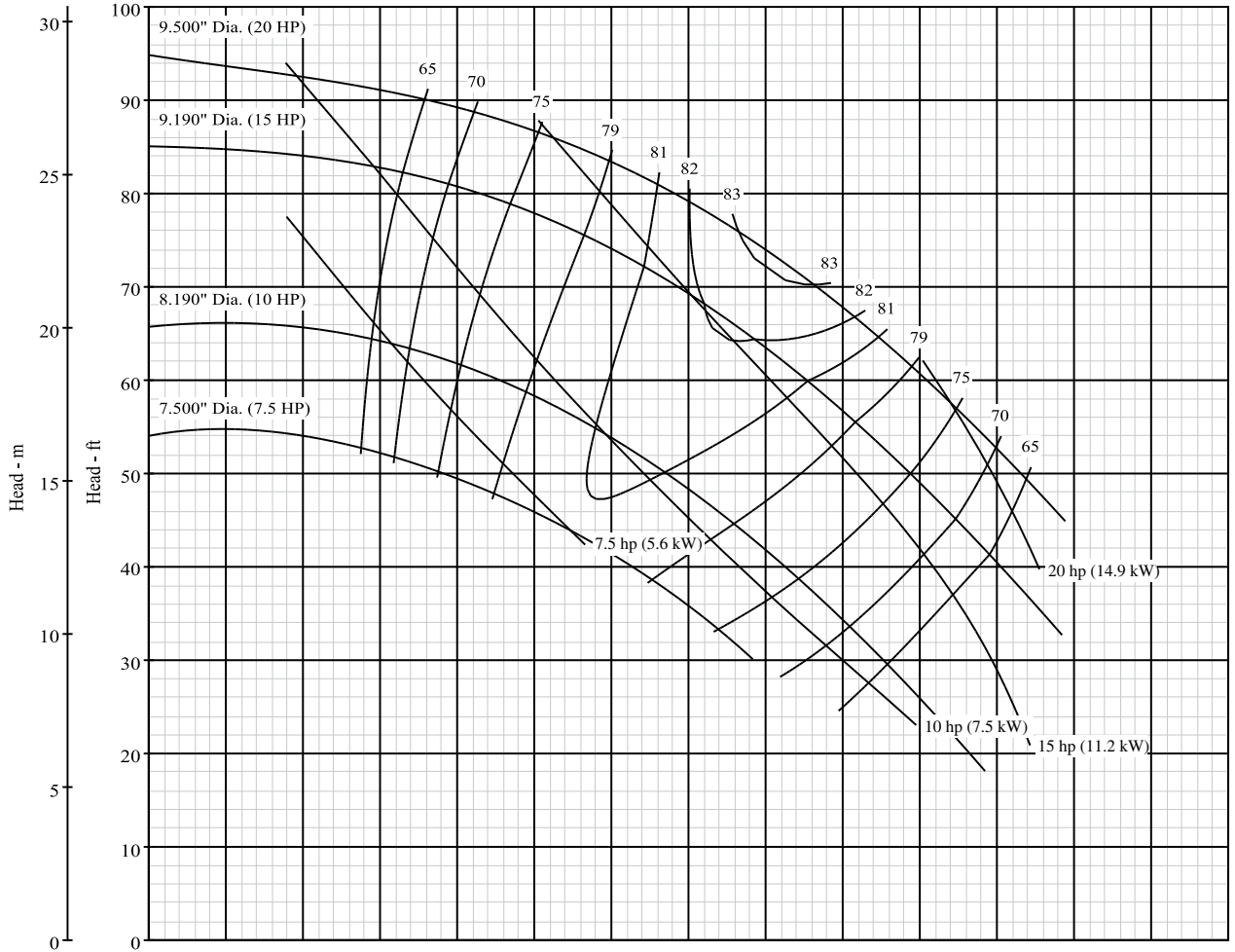

Pump Size: 4 x 5 x 9.5 BH

Model: B4Z_BH

Curve No.

Type	CCMD	FM CPLG	FM BELT	SAE	Hydraulic	AC Engine
Model	B4ZPBH	B4ZRBH	B4ZRBH	B4ZQBH		
RPM	1200-1800	1600-2800	1600-2500	1600-2800		

Dia. 9.50"

Nominal RPM: **VARIOUS**
 Based on Fresh Water @ 68°F (20°C)
 Maximum Working Pressure: 175 PSI (12 BAR)

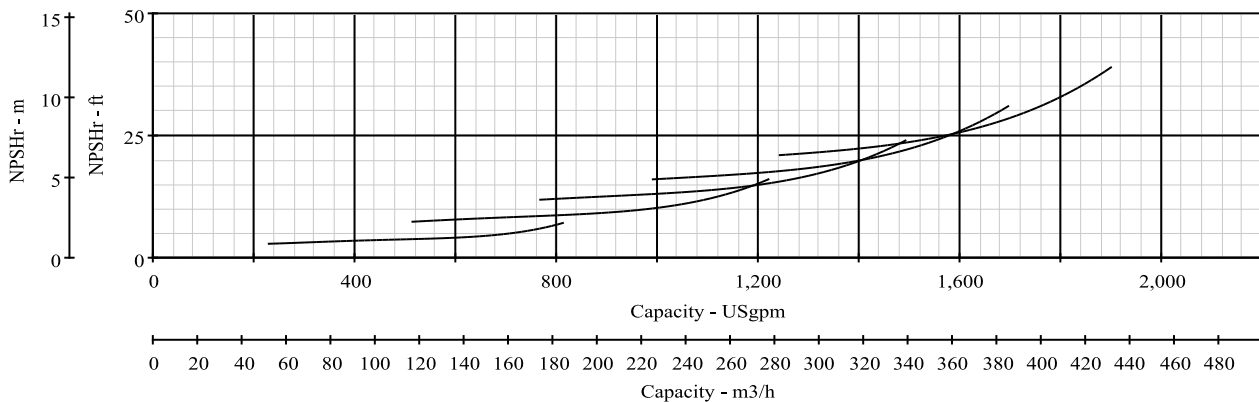
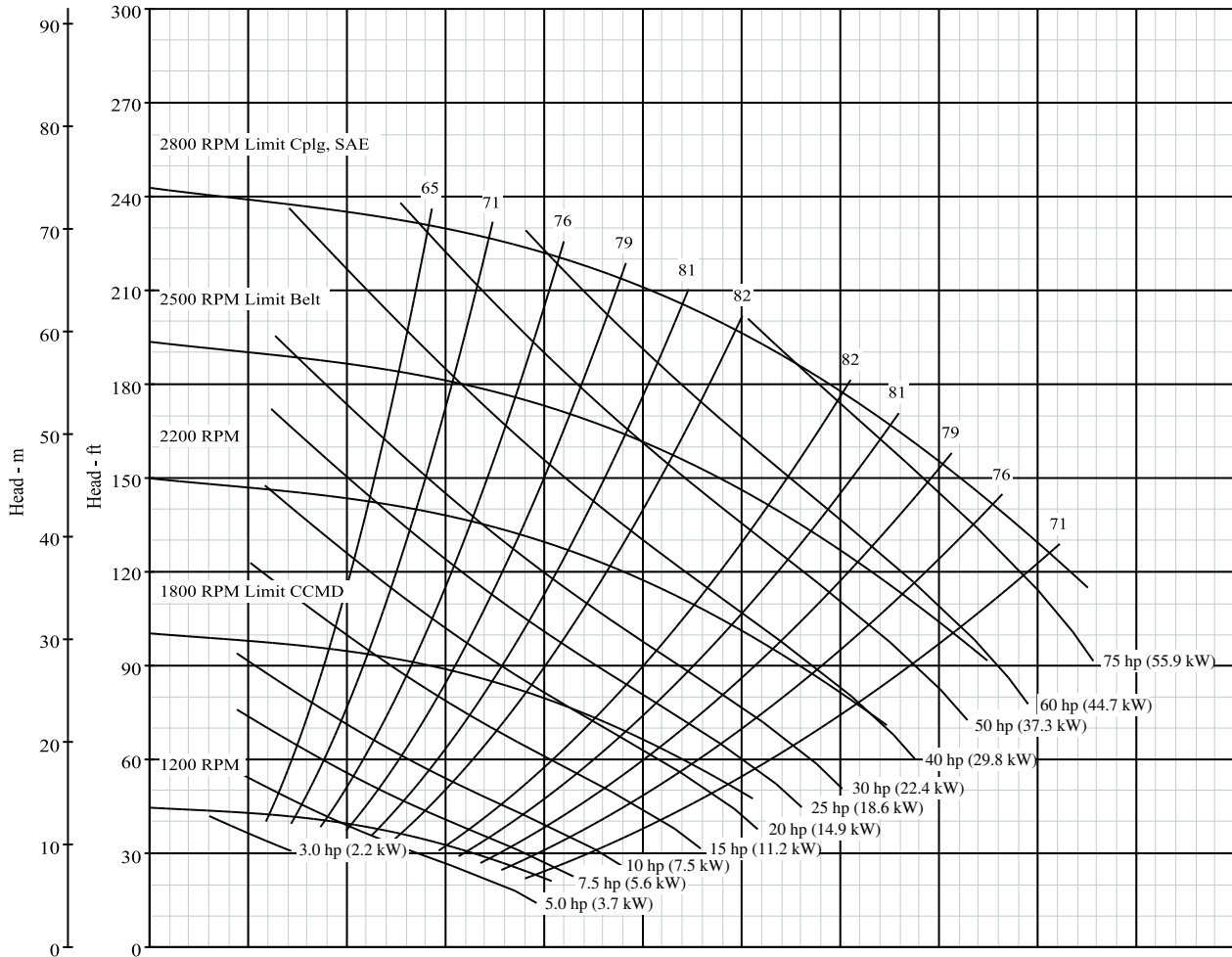

*NPSH data shown is at maximum speed

Pump Size: 5 x 6 x 9.5 BH

Model: B5Z_BH

Curve No.

Type	CCMD	FM CPLG	FM BELT	SAE	Hydraulic	AC Engine
Model	B5ZPBH	B5ZRBH	B5ZRBH	B5ZQBH		

Nominal RPM: **1750**
 Based on Fresh Water @ **68°F (20°C)**
 Maximum Working Pressure: **175 PSI (12 BAR)**

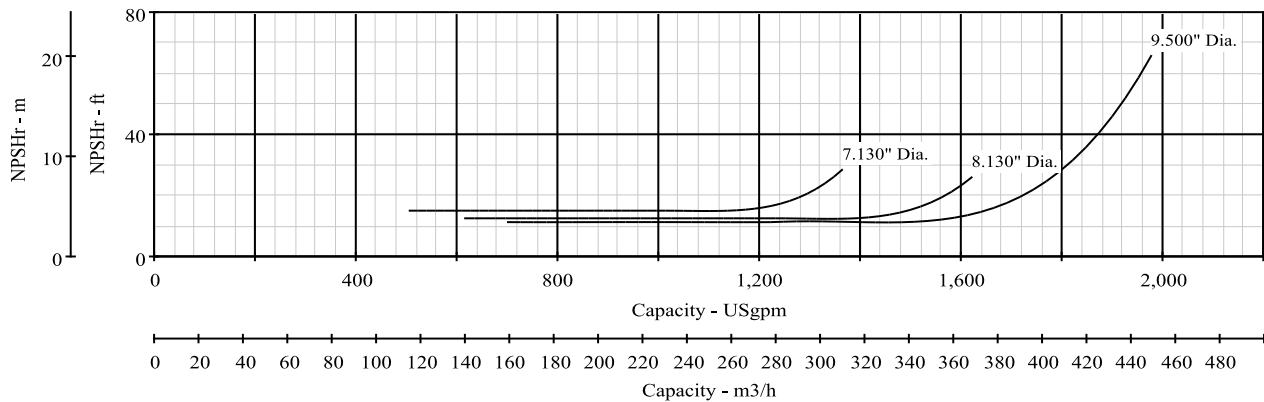
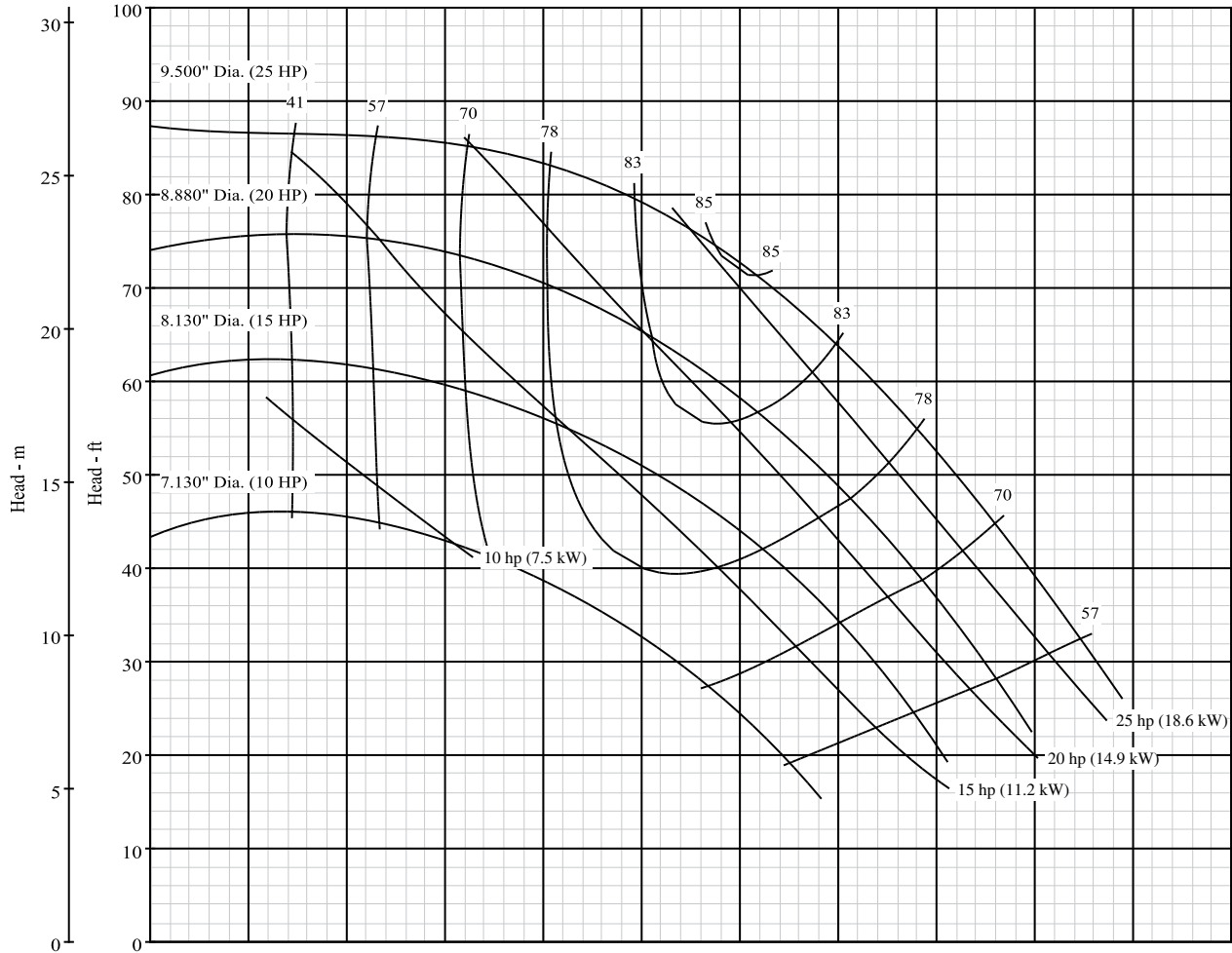

Pump Size: 5 x 6 x 9.5 BH

Model: B5Z_BH

Curve No.

Type	CCMD	FM CPLG	FM BELT	SAE	Hydraulic	AC Engine
Model	B5ZPBH	B5ZRBH	B5ZRBH	B5ZQBH		
RPM	1200-1800	1600-2500	1600-2200	1600-2500		

Dia. 9.50"

Nominal RPM: **VARIOUS**
 Based on Fresh Water @ 68°F (20°C)
 Maximum Working Pressure: 175 PSI (12 BAR)

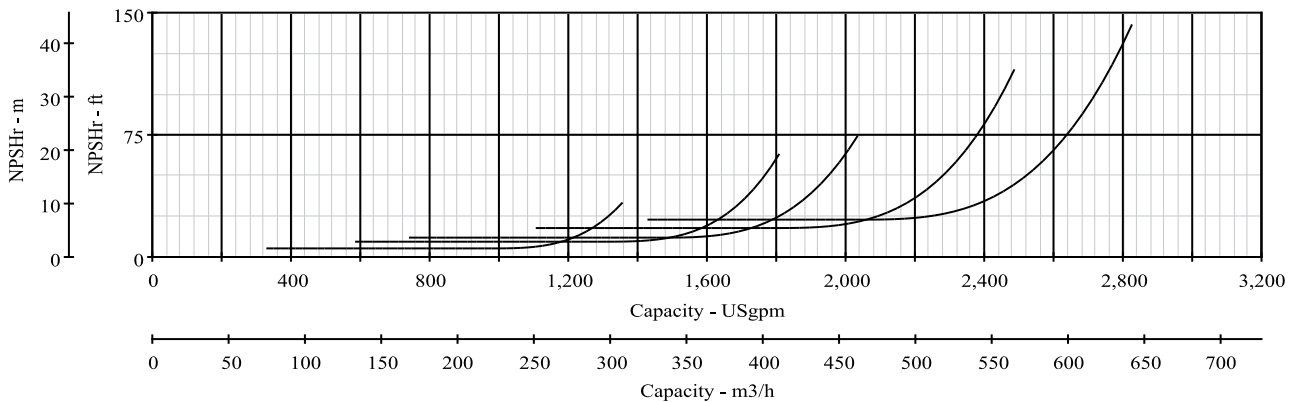
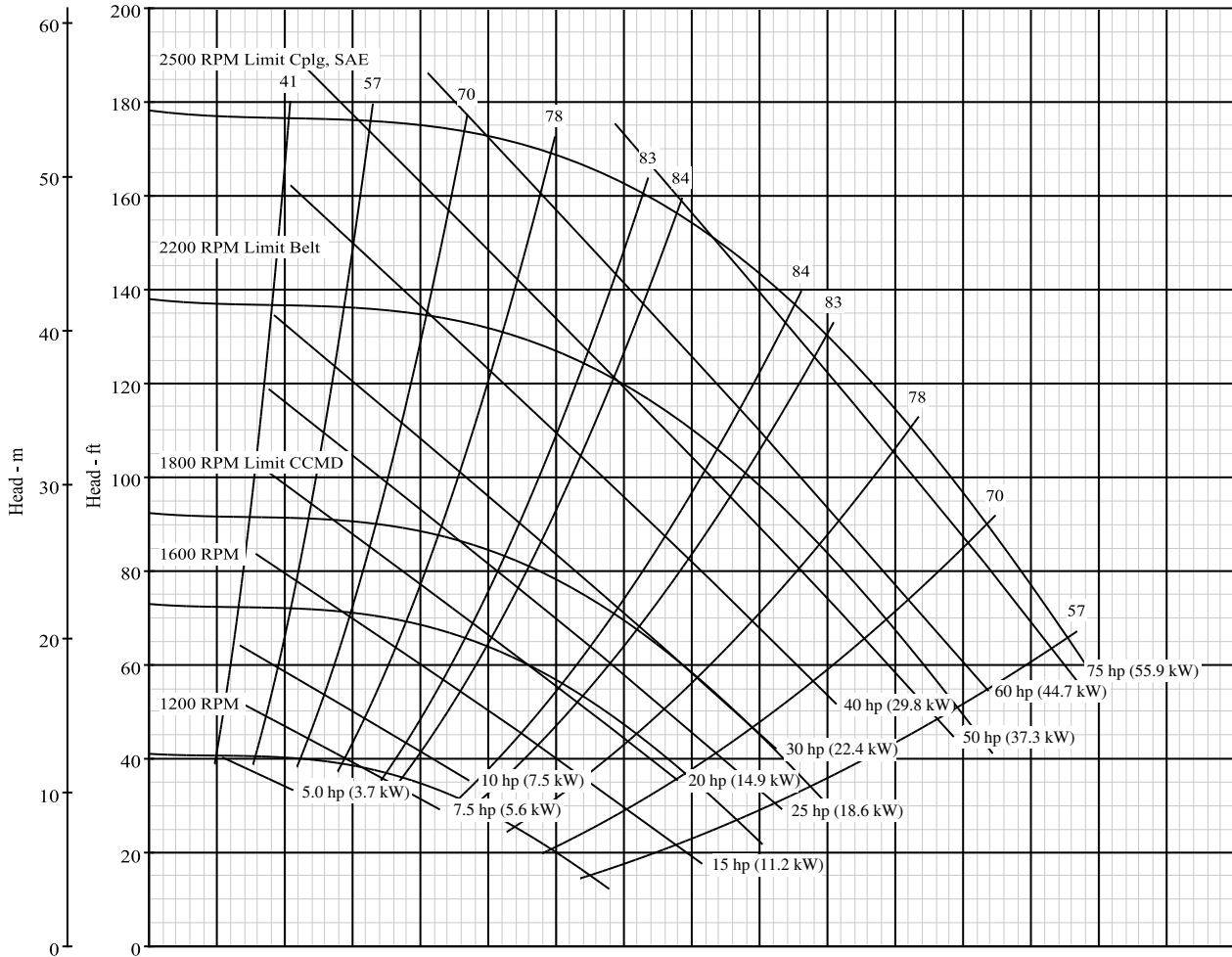

*NPSH data shown is at maximum speed

Pump Size: 6 x 8 x 9 L

Model: B6Z_L

Curve No. 5838

Type	CCMD	FM CPLG	FM BELT	SAE	Hydraulic	AC Engine
Model	B6ZPL	B6ZRL	B6ZRL	B6ZQL		

Nominal RPM: **1750**
 Based on Fresh Water @ **68°F (20°C)**
 Maximum Working Pressure: **266 PSI (18 BAR)**

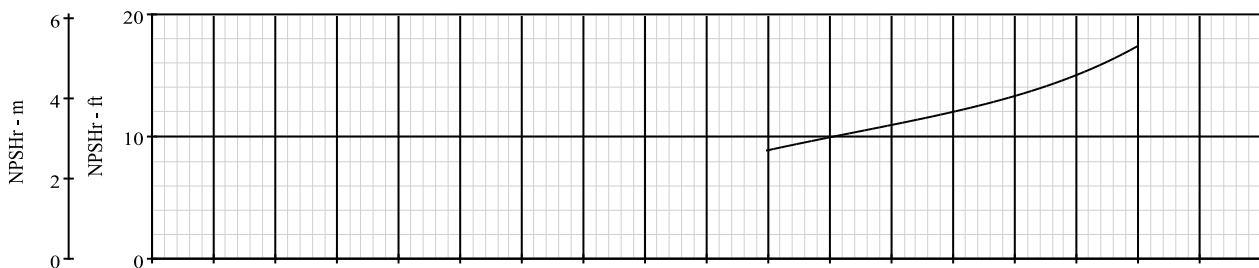
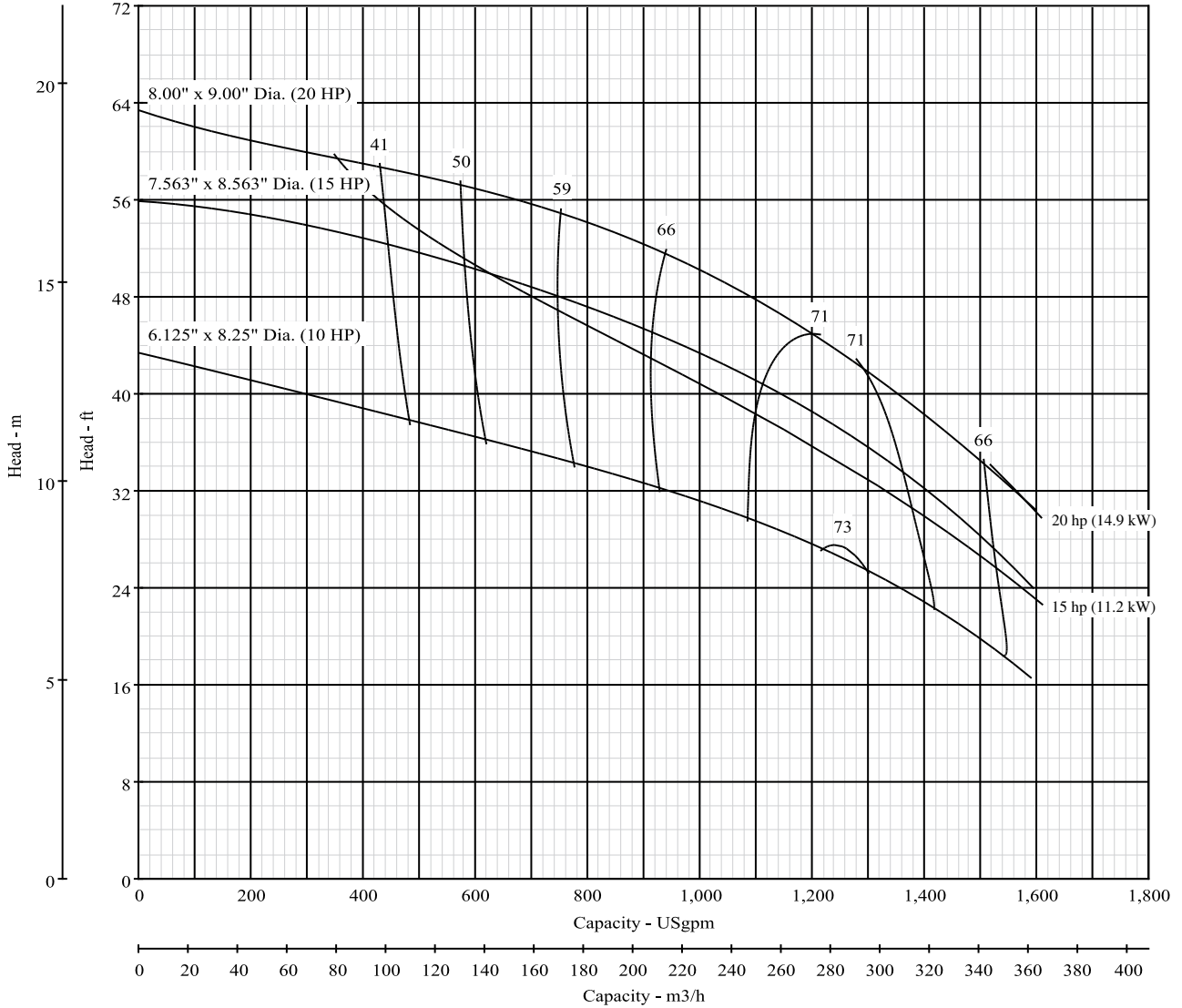

Pump Size: 6 x 8 x 9 L

Model: B6Z_L

Curve No. 5838

Type	CCMD	FM CPLG	FM BELT	SAE	Hydraulic	AC Engine
Model	B6ZPL	B6ZRL	B6ZRL	B6ZQL		
RPM	1201-1800	1400-2300	1400-2100	1200-1800		

Dia. 8.50" Nominal RPM: **VARIOUS**
Based on Fresh Water @ 68°F (20°C)
Maximum Working Pressure: 266 PSI (18 BAR)

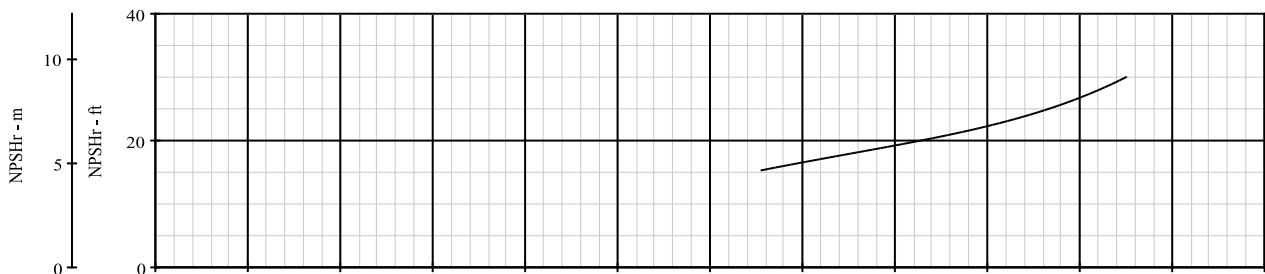
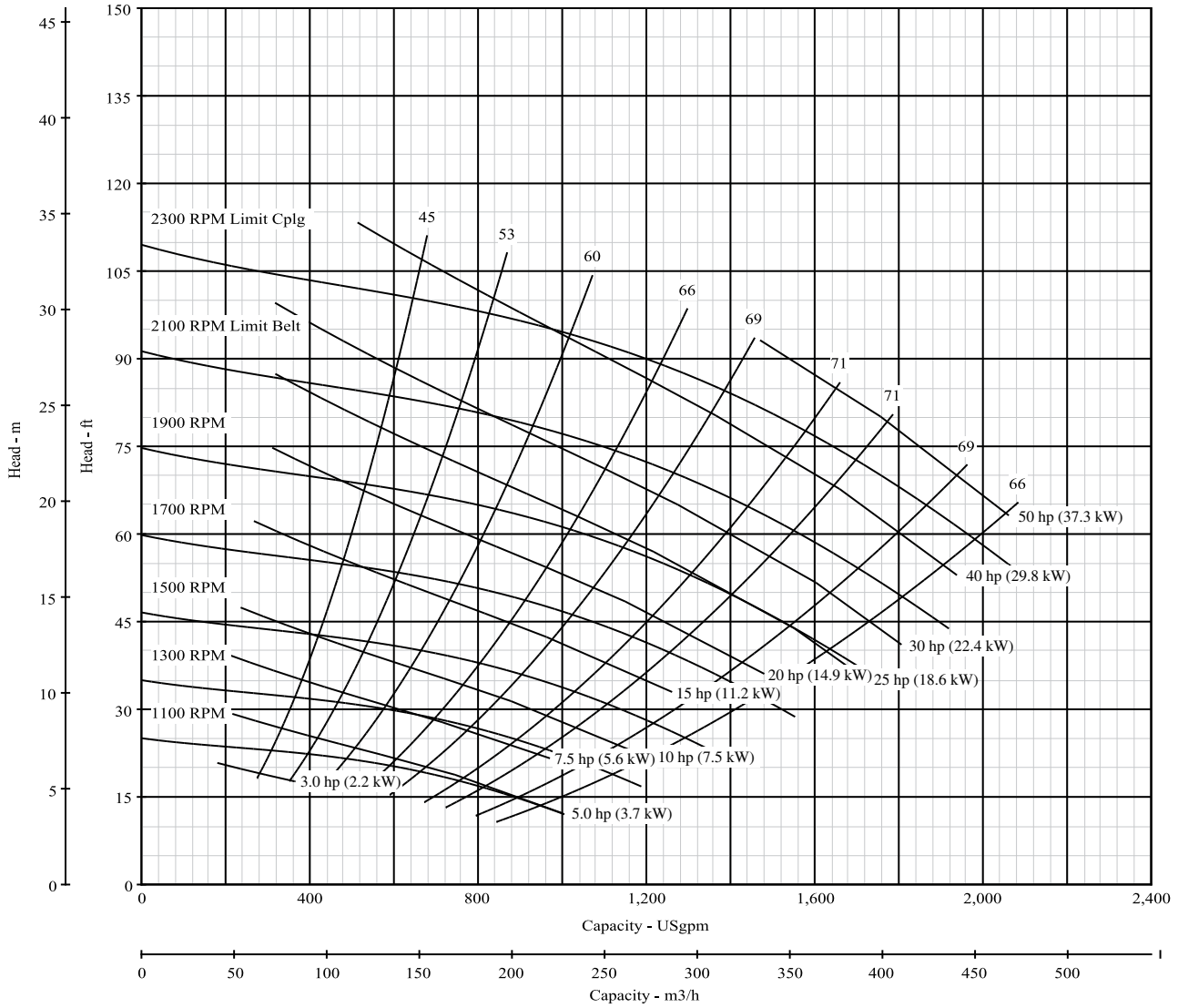

*NPSH data shown is at maximum speed

Pump Size: 6 x 8 x 9 M-CCW

Model: B6Z_M-CCW

Curve No. 7417

Type	CCMD	FM CPLG	FM BELT	SAE	Hydraulic	AC Engine
Model		B6ZRM-CCW	B6ZRM-CCW			

Nominal RPM: **1750**
 Based on Fresh Water @ **68°F (20°C)**
 Maximum Working Pressure: **266 PSI (18 BAR)**

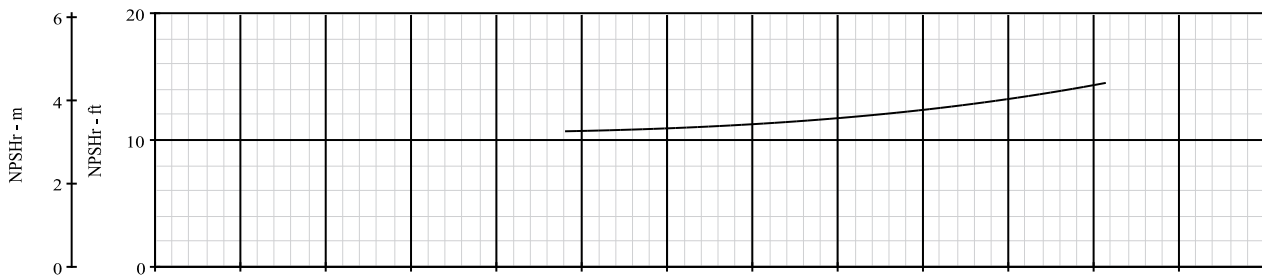
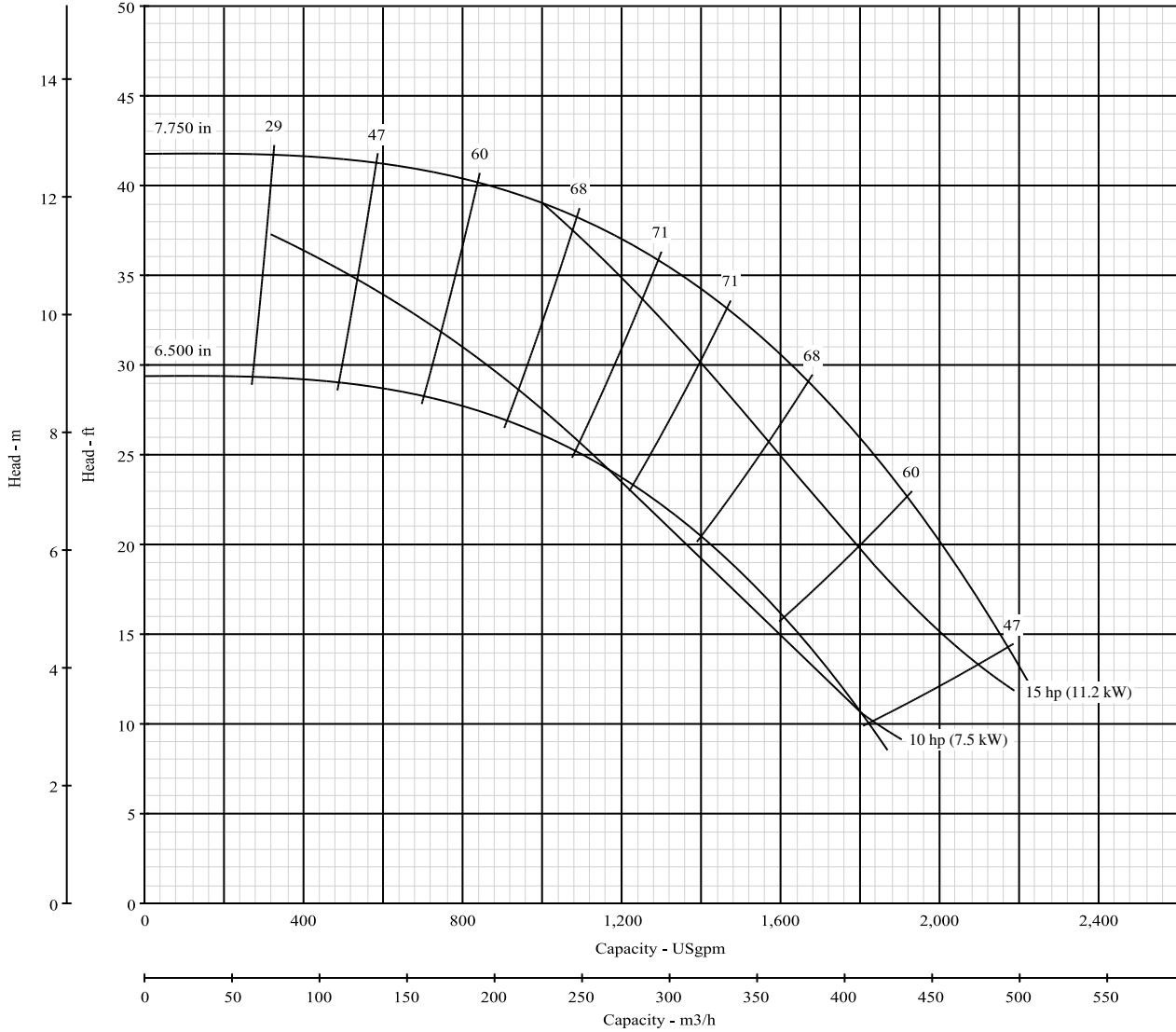

Pump Size: 6 x 8 x 9 M-CCW

Model: B6Z_M-CCW

Curve No. 7417

Type	CCMD	FM CPLG	FM BELT	SAE	Hydraulic	AC Engine
Model		B6ZRM-CCW	B6ZRM-CCW			
RPM		1600-2200	1600-2200			

Dia. 7.75"

Nominal RPM: **VARIOUS**
 Based on Fresh Water @ 68°F (20°C)
 Maximum Working Pressure: 266 PSI (18 BAR)

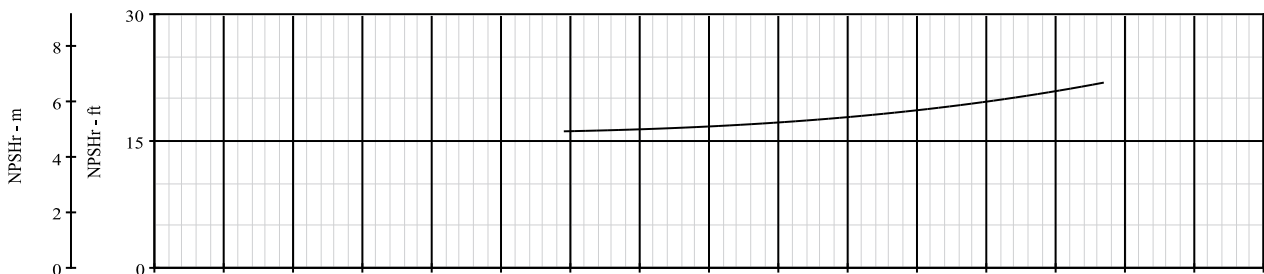
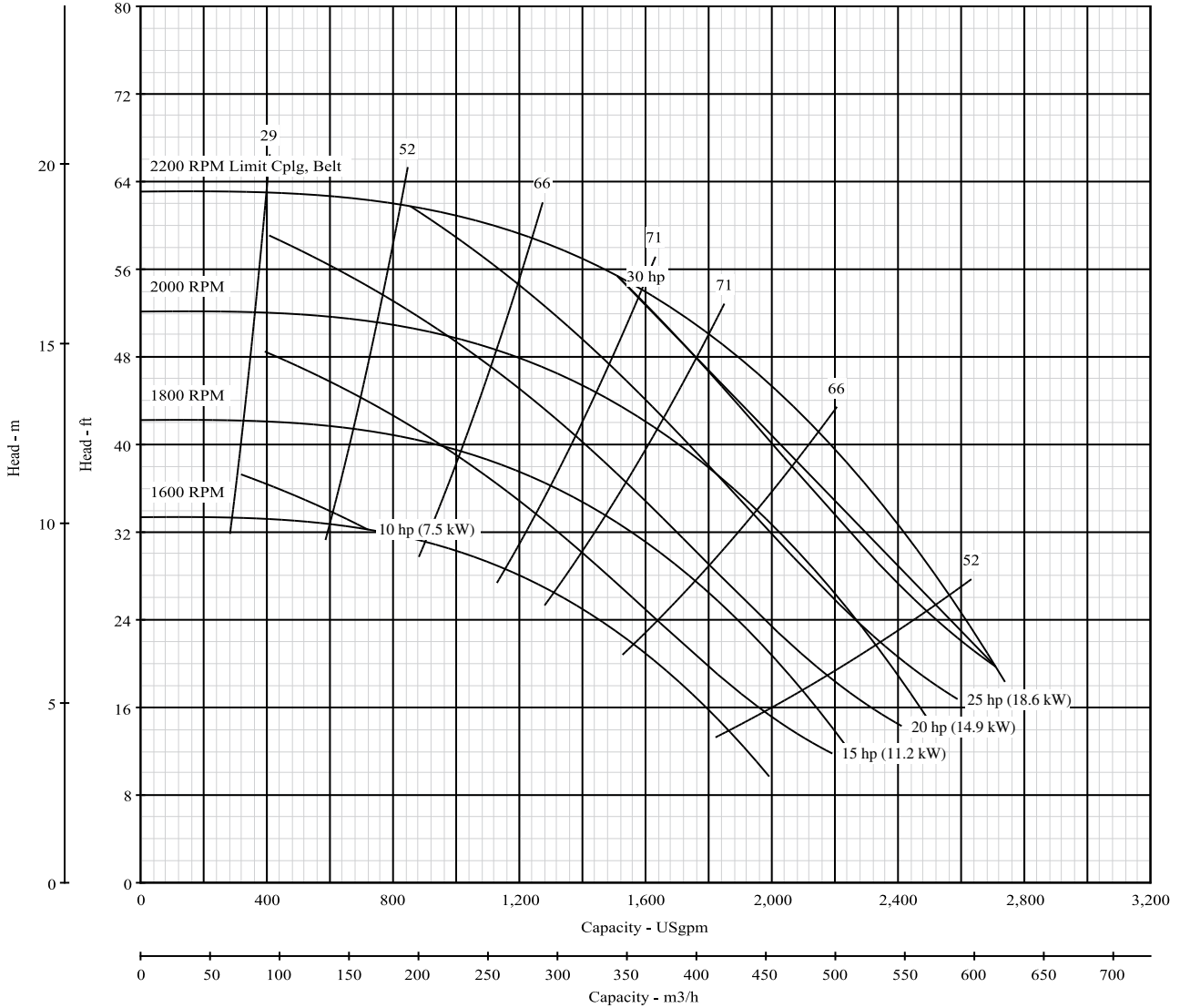

*NPSH data shown is at maximum speed

Pump Size: 6 x 8 x 9 H

Model: B6Z_H

Curve No. 9027

Type	CCMD	FM CPLG	FM BELT	SAE	Hydraulic	AC Engine
Model	B6ZPH	B6ZRH	B6ZPH	B6ZQH		

Nominal RPM: **1750**
 Based on Fresh Water @ **68°F (20°C)**
 Maximum Working Pressure: **266 PSI (18 BAR)**

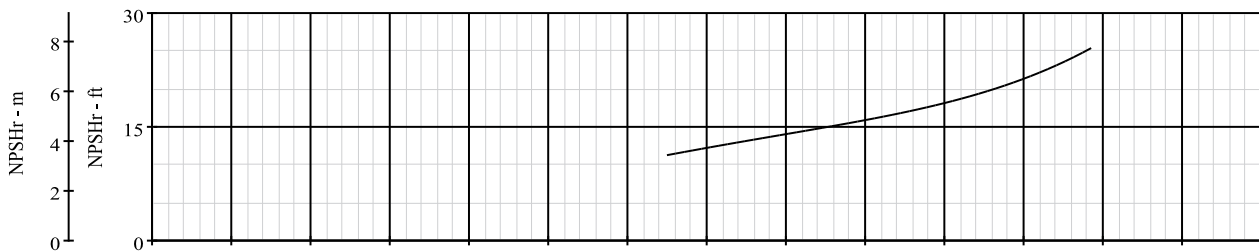
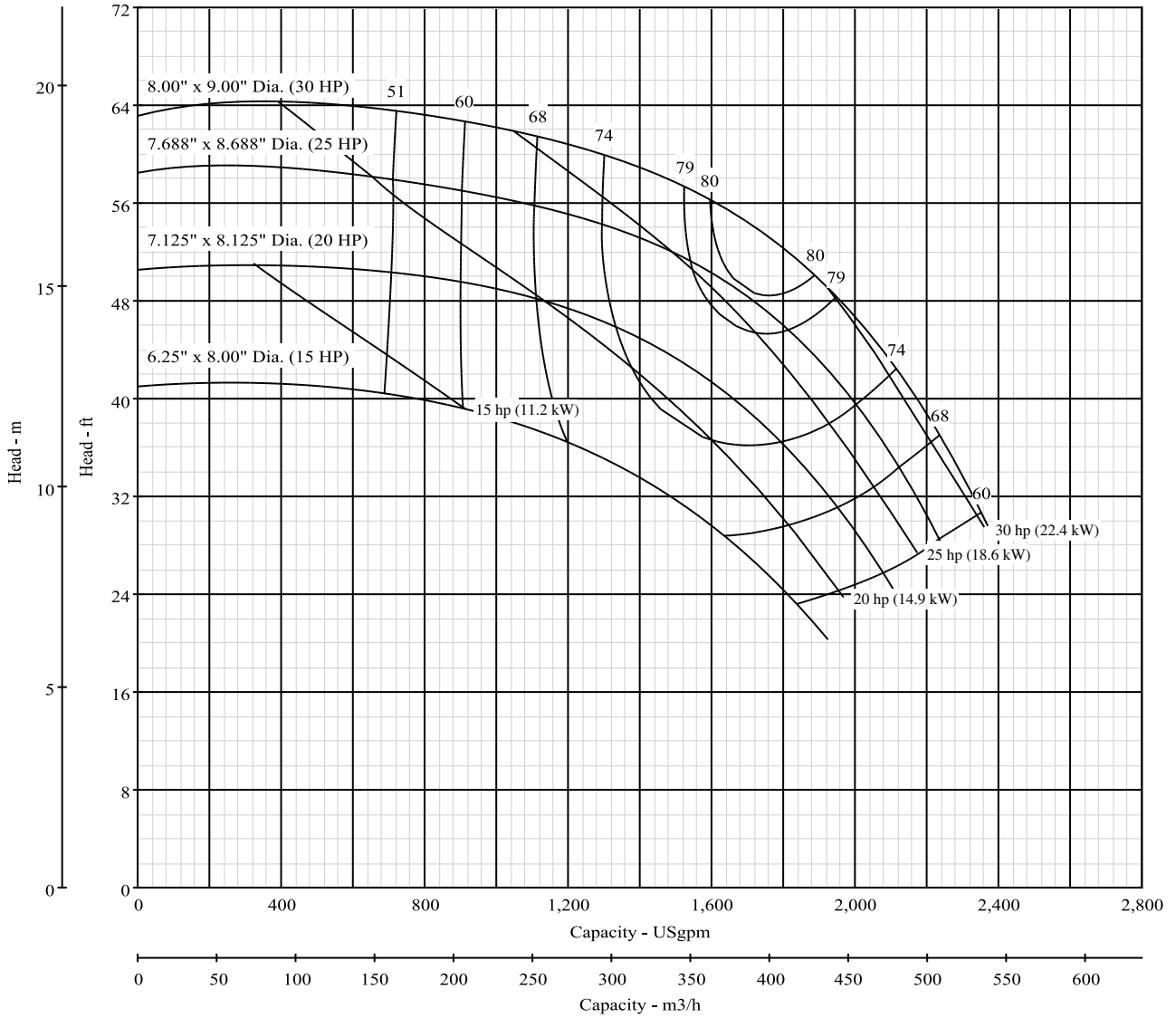

Pump Size: 6 x 8 x 9 H

Model: B6Z_H

Curve No. 9027

Type	CCMD	FM CPLG	FM BELT	SAE	Hydraulic	AC Engine
Model	B6ZPH	B6ZRH	B6ZPH	B6ZQH		
RPM	1201-1800	1200-2000	1200-1900	1200-1800		

Dia. 9.00" Nominal RPM: **VARIOUS**
Based on Fresh Water @ 68°F (20°C)
Maximum Working Pressure: 266 PSI (18 BAR)

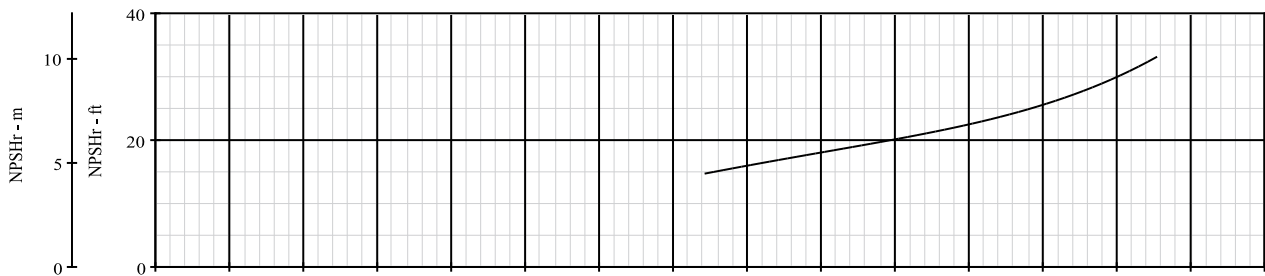
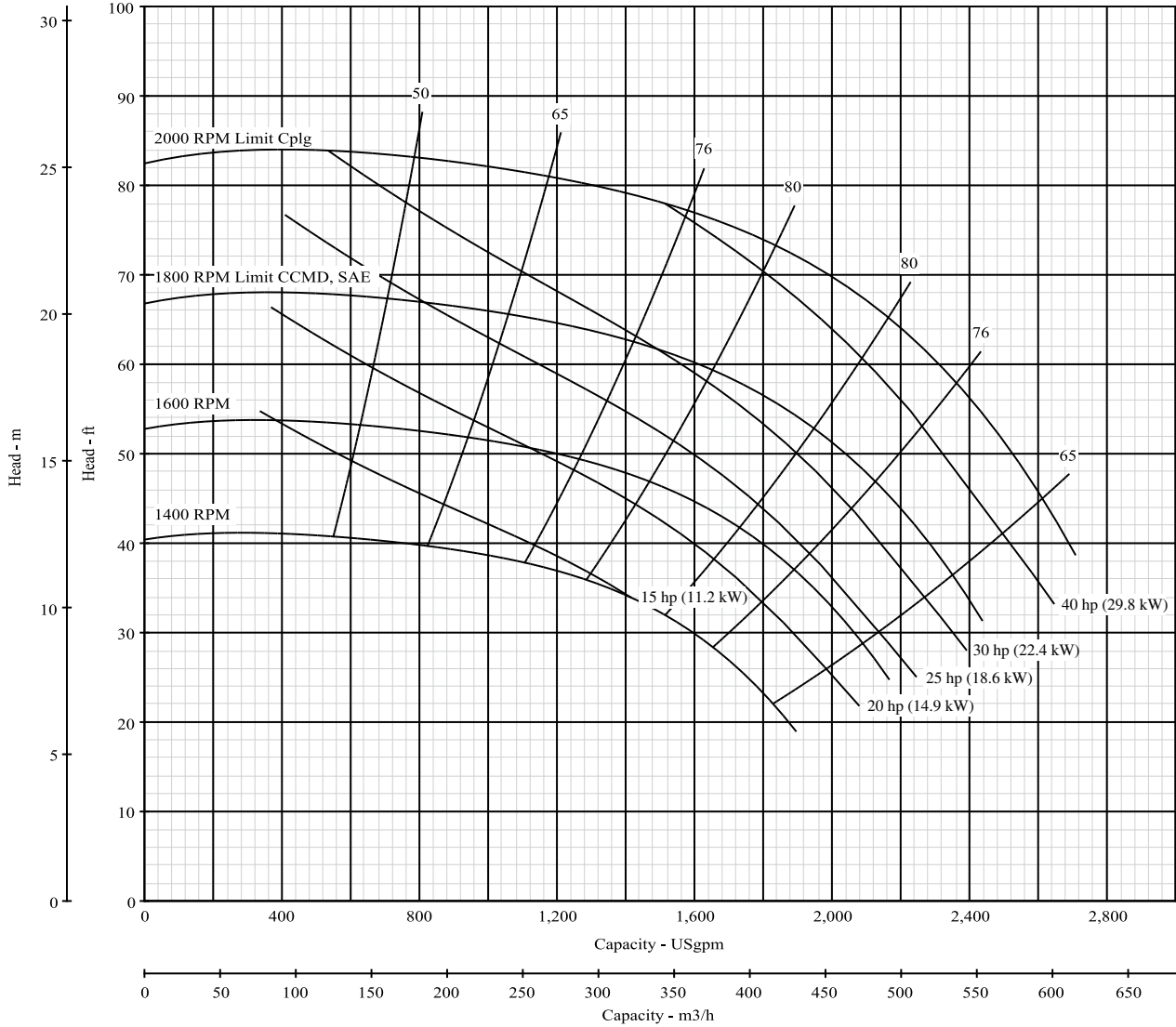

*NPSH data shown is at maximum speed

Pump Size: 6 x 8 x 9.5 BHH

Model: B6Z_BHH(S)

Curve No.

Type	CCMD	FM CPLG	FM BELT	SAE	Hydraulic	AC Engine
Model	B6ZPBHH	B6ZRBHH	B6ZRBHH	B6ZQBHH		

Nominal RPM: **1750**
 Based on Fresh Water @ **68°F (20°C)**
 Maximum Working Pressure: **175 PSI (12 BAR)**

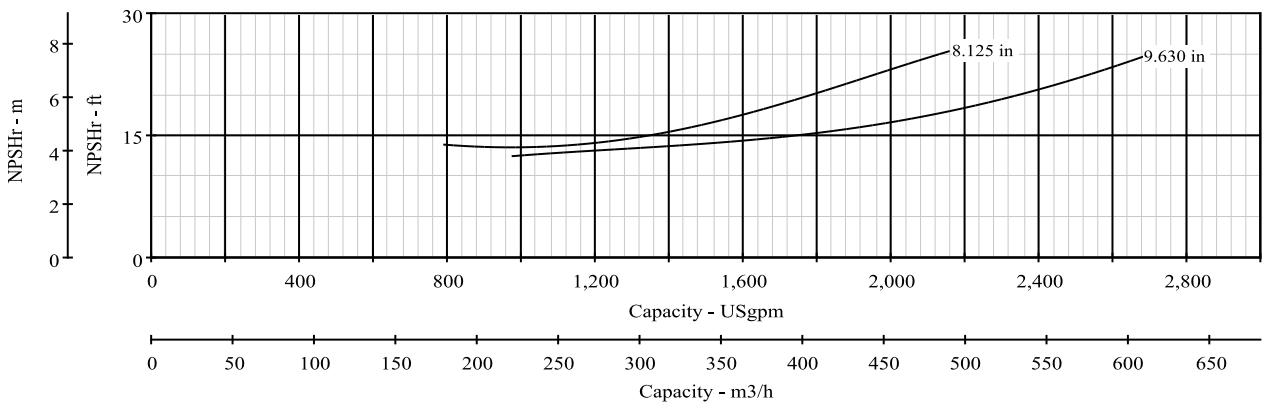
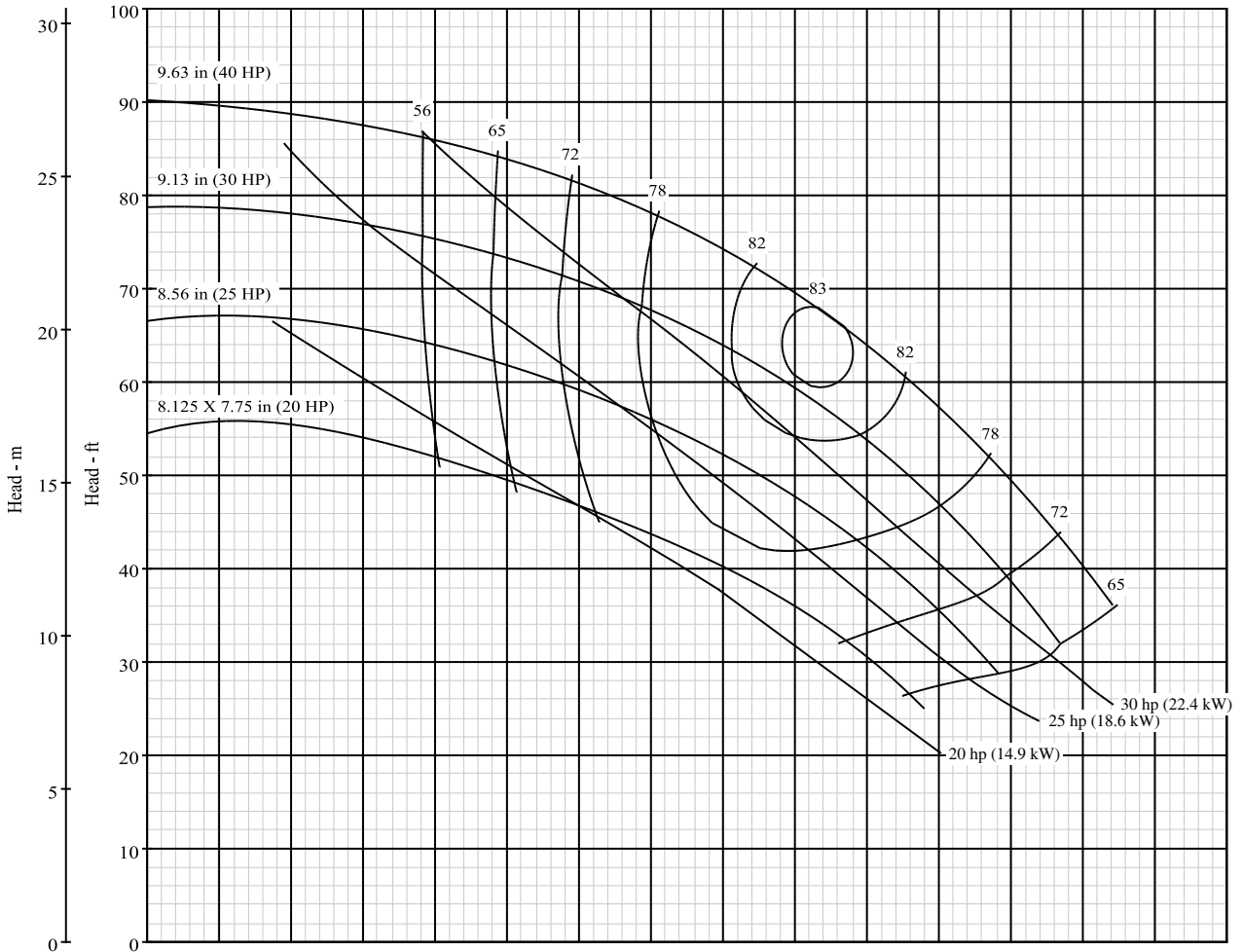

Pump Size: 6 x 8 x 9.5 BHH

Model: B6Z_BHH(S)

Curve No.

Type	CCMD	FM CPLG	FM BELT	SAE	Hydraulic	AC Engine
Model	B6ZPBHH	B6ZRBHH	B6ZRBHH	B6ZQBHH		
RPM	1201-1800	1600-2000	1600-2000	1600-2000		

Full Dia. 9.63"

Nominal RPM: **VARIOUS**
 Based on Fresh Water @ 68°F (20°C)
 Maximum Working Pressure: 175 PSI (12 BAR)

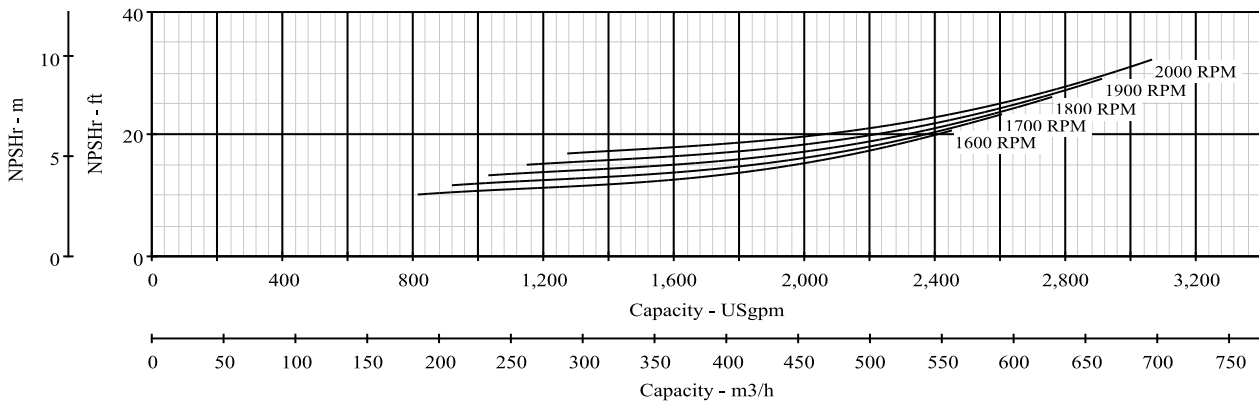
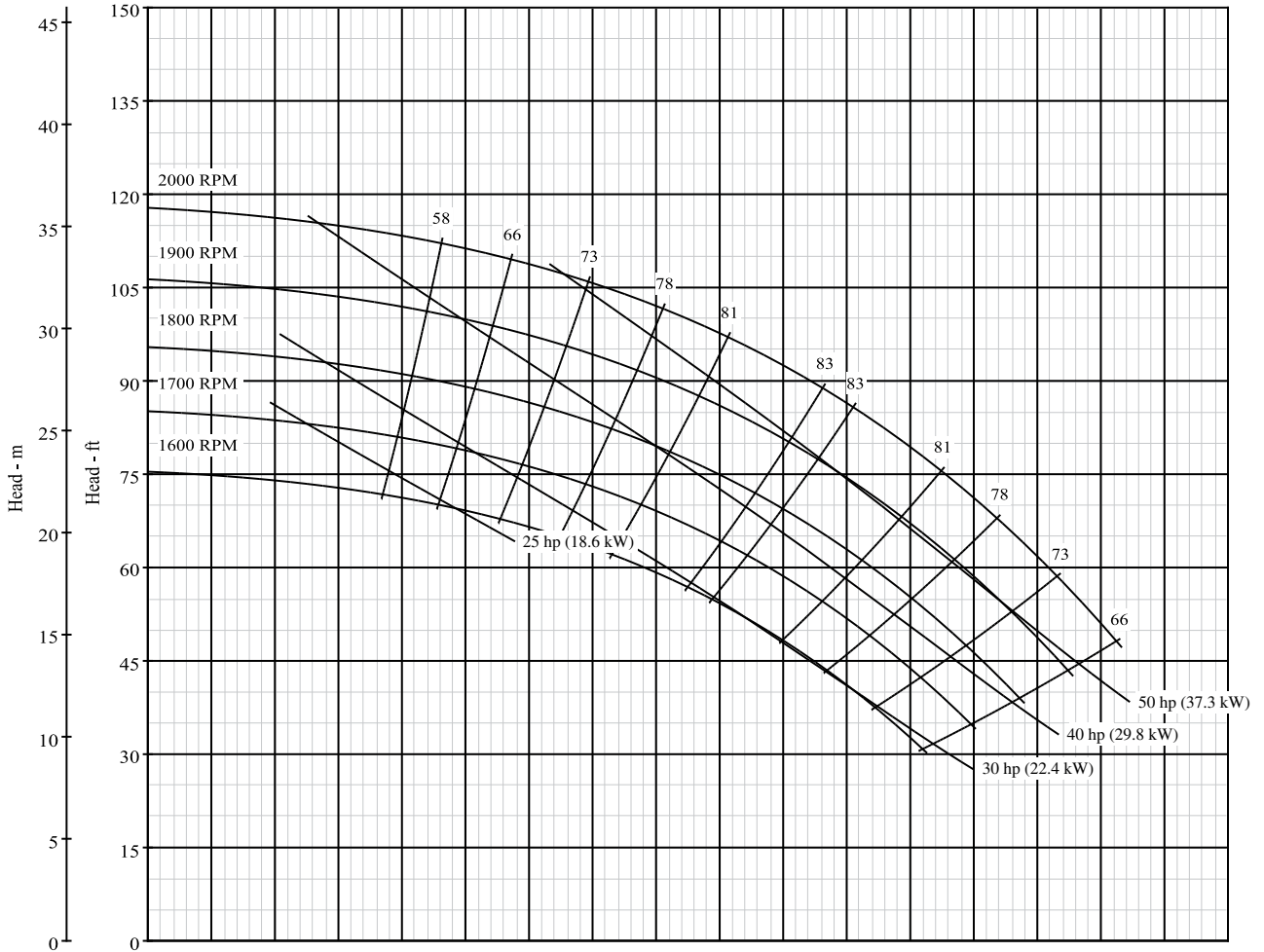

*NPSH data shown is at maximum speed

Pump Size: 1-1/2 x 2 x 10 L

Model: B1-1/2E_L

Curve No. 9089

Type	CCMD	FM CPLG	FM BELT	SAE	Hydraulic	AC Engine
Model	B1-1/2EPL					

Nominal RPM: **3500**
 Based on Fresh Water @ **68°F (20°C)**
 Maximum Working Pressure: **266 PSI (18 BAR)**

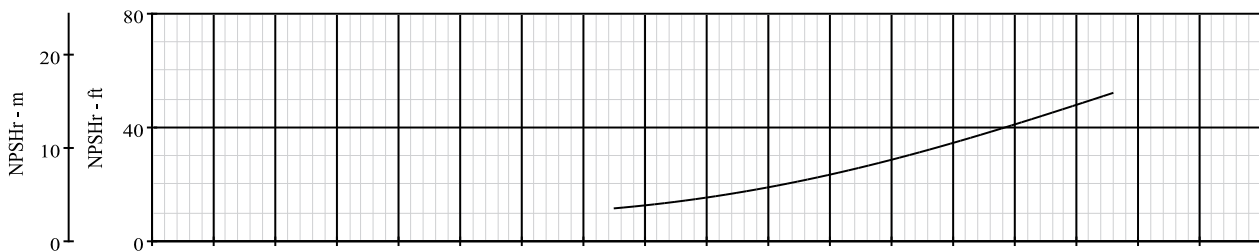
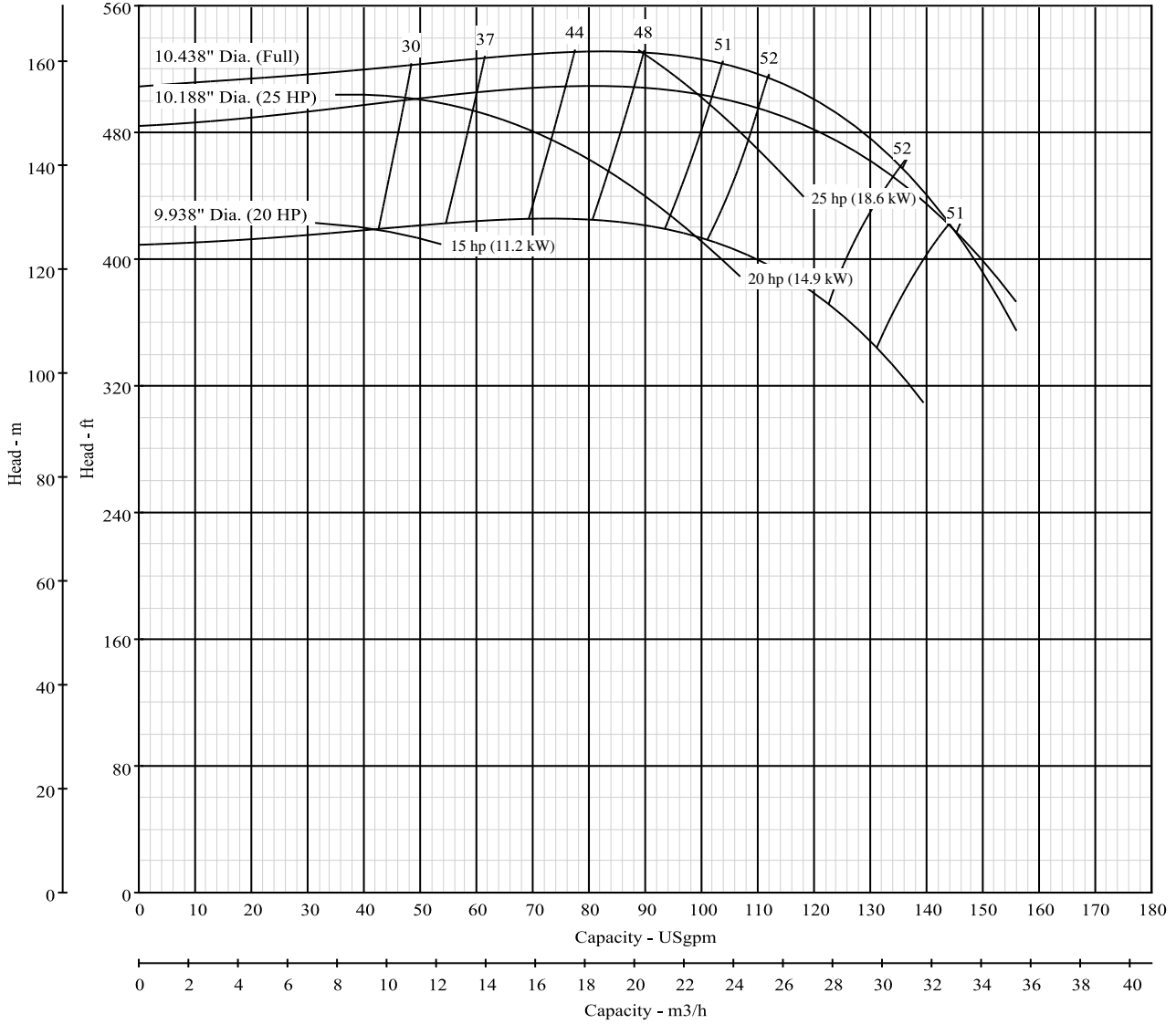

Pump Size: 1-1/2 x 2 x 10 L

Model: B1-1/2E_L

Curve No. 9089

Type	CCMD	FM CPLG	FM BELT	SAE	Hydraulic	AC Engine
Model	B1-1/2EPL	B1-1/2ERL	B1-1/2ERL	B1-1/2EQL		
RPM	1801-3600	1800-3000	1800-2800	2000-3200		

Dia. 10.44"

Nominal RPM: **VARIOUS**
 Based on Fresh Water @ 68°F (20°C)
 Maximum Working Pressure: 266 PSI (18 BAR)

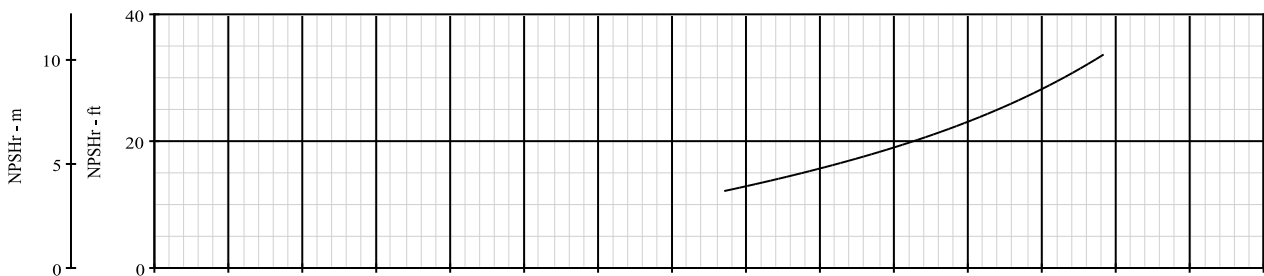
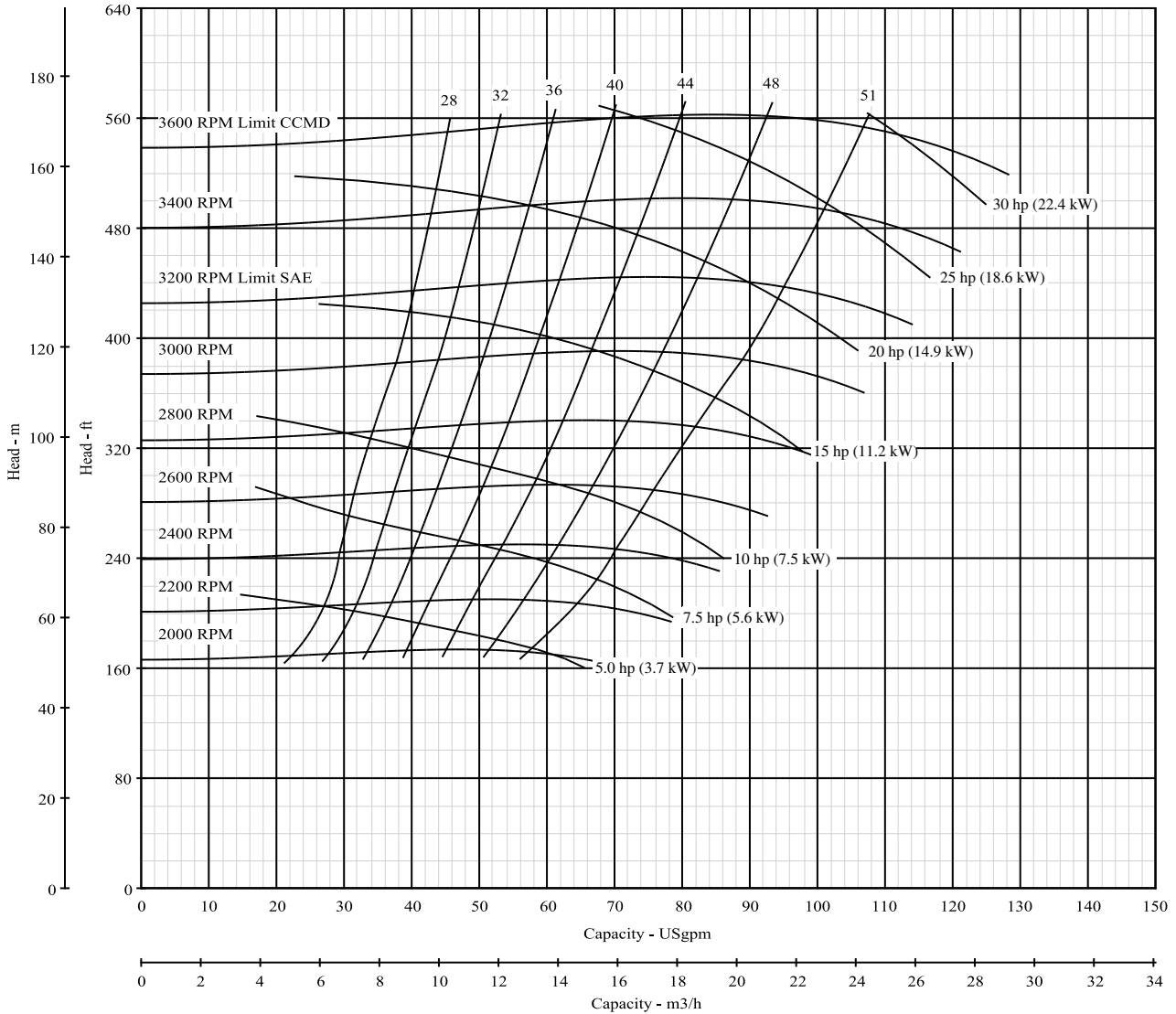

*NPSH data shown is at maximum speed

Pump Size: 2 x 3 x 10 BL

Model: B2E_BL

Curve No. 6541

Type	CCMD	FM CPLG	FM BELT	SAE	Hydraulic	AC Engine
Model	B2EPBL					

Nominal RPM: **3500**
 Based on Fresh Water @ **68°F (20°C)**
 Maximum Working Pressure: **266 PSI (18 BAR)**

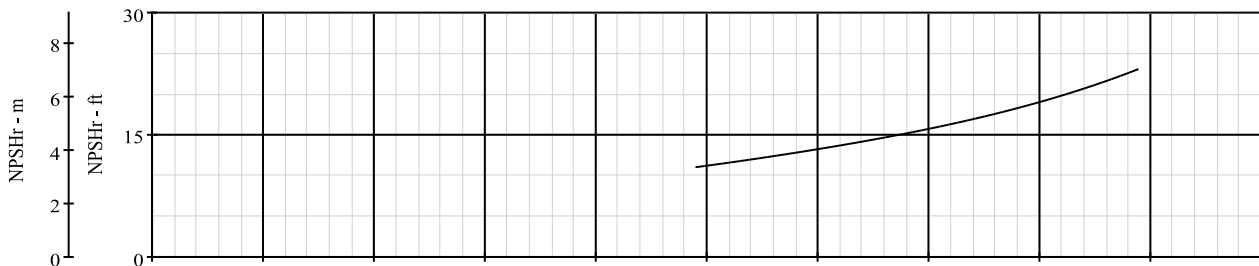
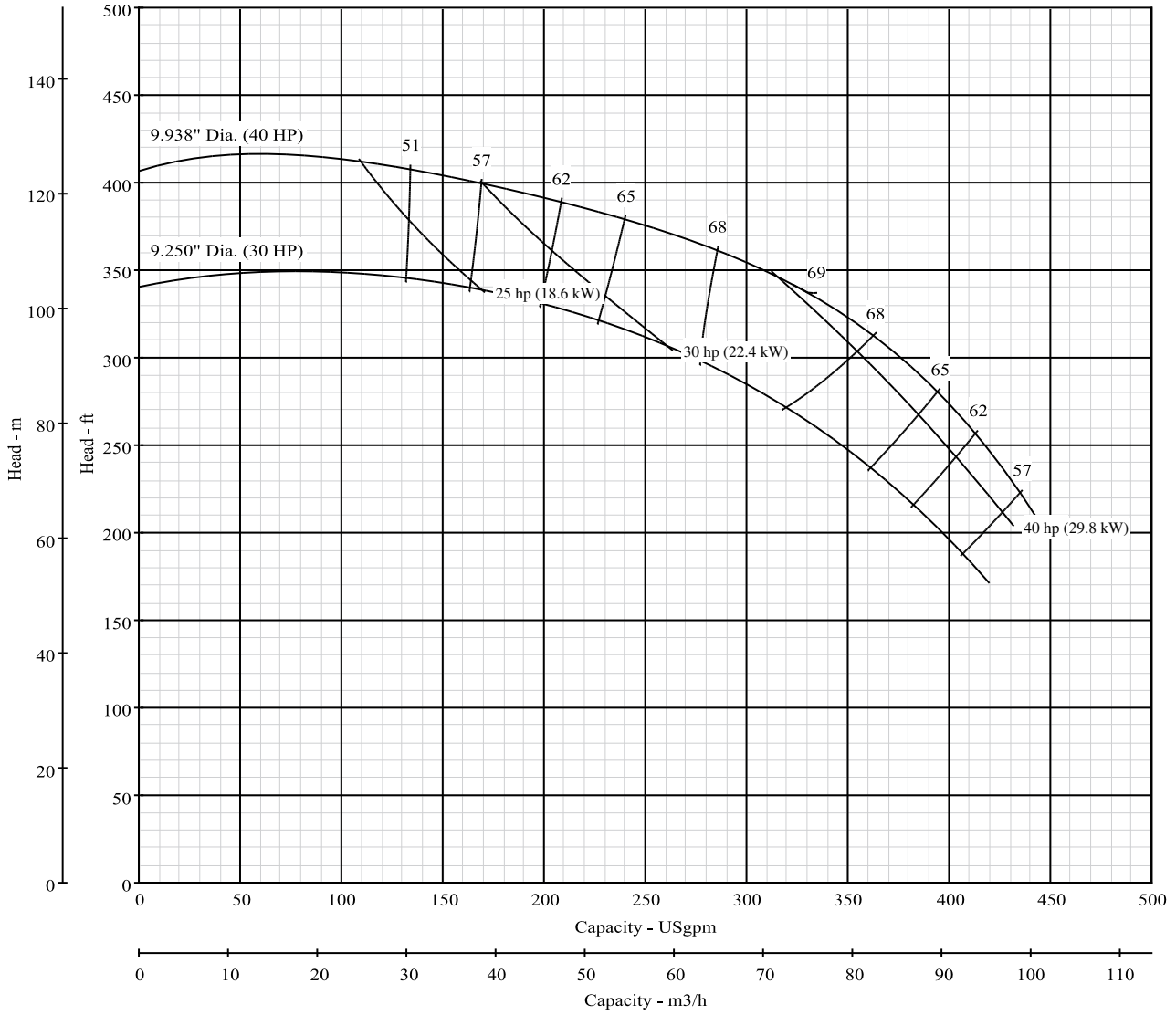

Pump Size: 2 x 3 x 10 BL

Model: B2E_BL

Curve No. 6541

Type	CCMD	FM CPLG	FM BELT	SAE	Hydraulic	AC Engine
Model	B2EPBL					
RPM	1801-3600					

Dia. 9.94"

Nominal RPM: **VARIOUS**
 Based on Fresh Water @ 68°F (20°C)
 Maximum Working Pressure: 266 PSI (18 BAR)

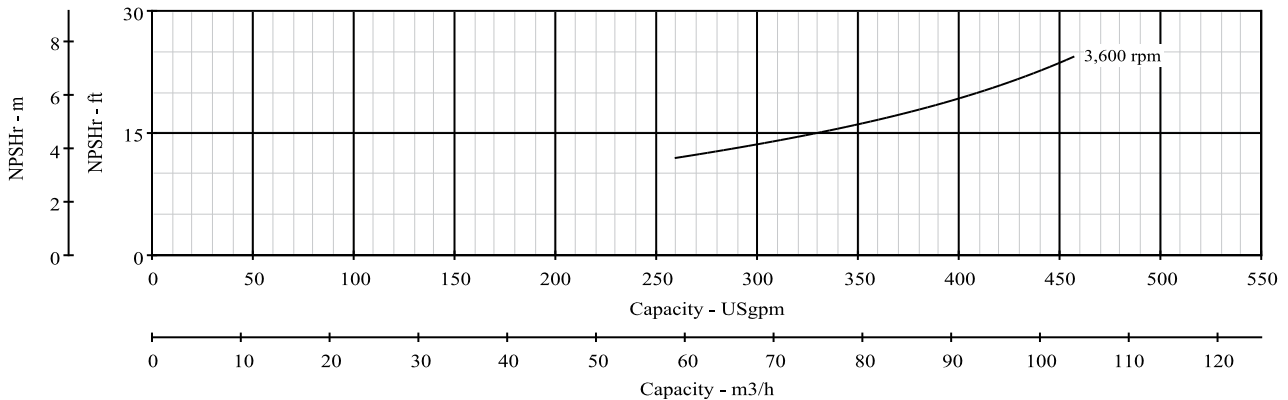
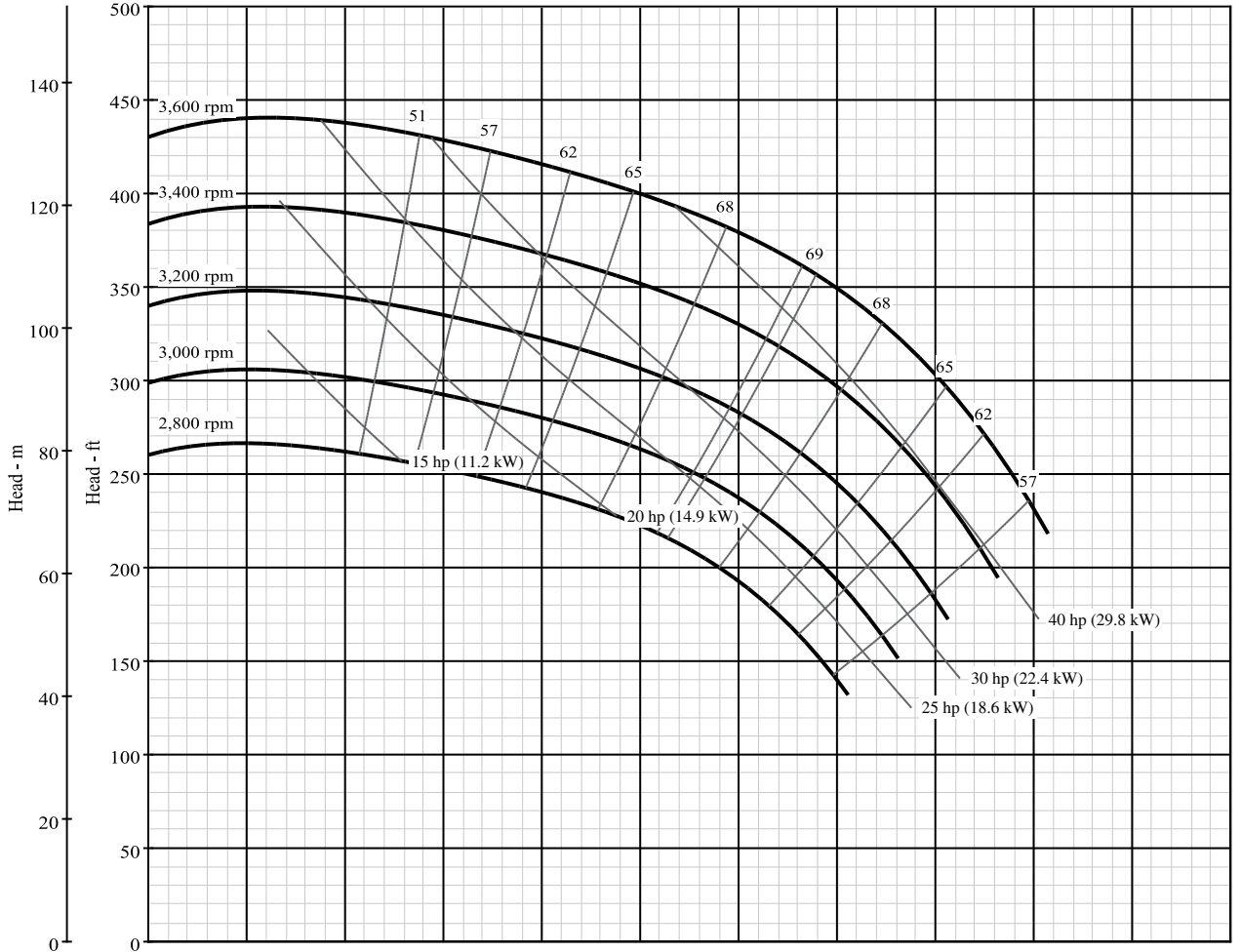

Pump Size: 2 x 3 x 10 BL

Model: B2E_L

Curve No. 7625

Type	CCMD	FM CPLG	FM BELT	SAE	Hydraulic	AC Engine
Model		B2ERL	B2ERL			
RPM		1800-3400	1800-2800			

Dia. 10.0"

Nominal RPM: **VARIOUS**
 Based on Fresh Water @ 68°F [20°C]
 Maximum Working Pressure: 266 PSI (18 BAR)

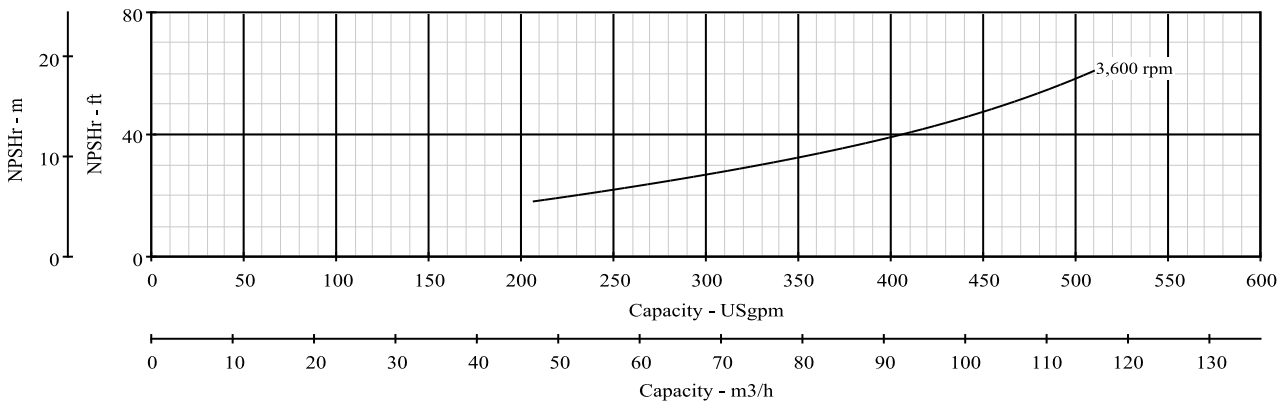
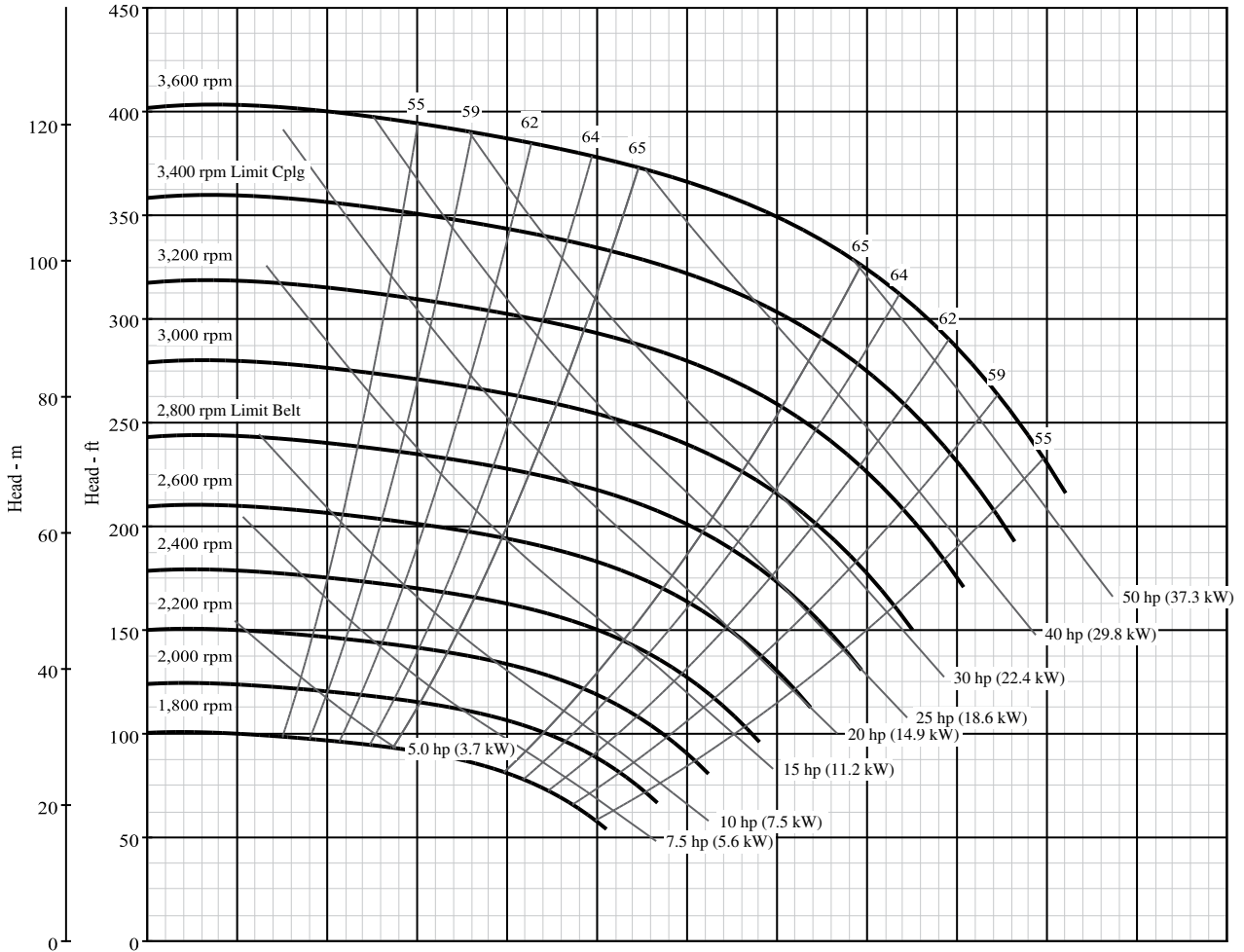

*NPSH data shown is at maximum speed

Pump Size: 2 x 3 x 10 H

Model: B2E_H

Curve No. 7626

Type	CCMD	FM CPLG	FM BELT	SAE	Hydraulic	AC Engine
Model		B2ERH	B2ERH			
RPM		1600-2800	1600-2400			

Dia. 9.94"

Nominal RPM: **VARIOUS**
 Based on Fresh Water @ 68°F (20°C)
 Maximum Working Pressure: 266 PSI (18 BAR)

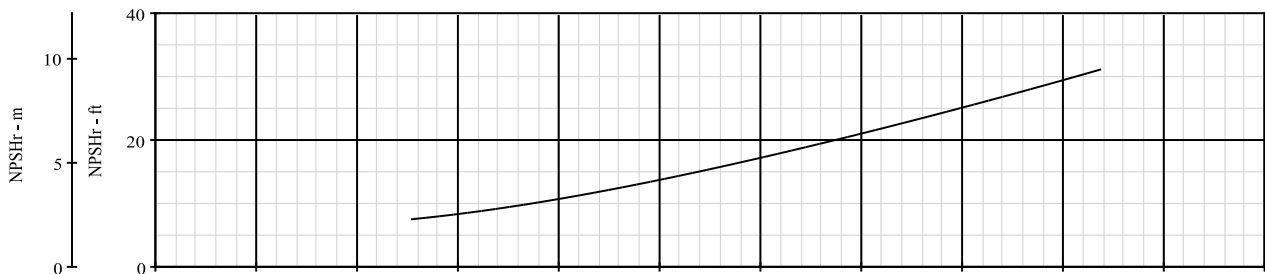
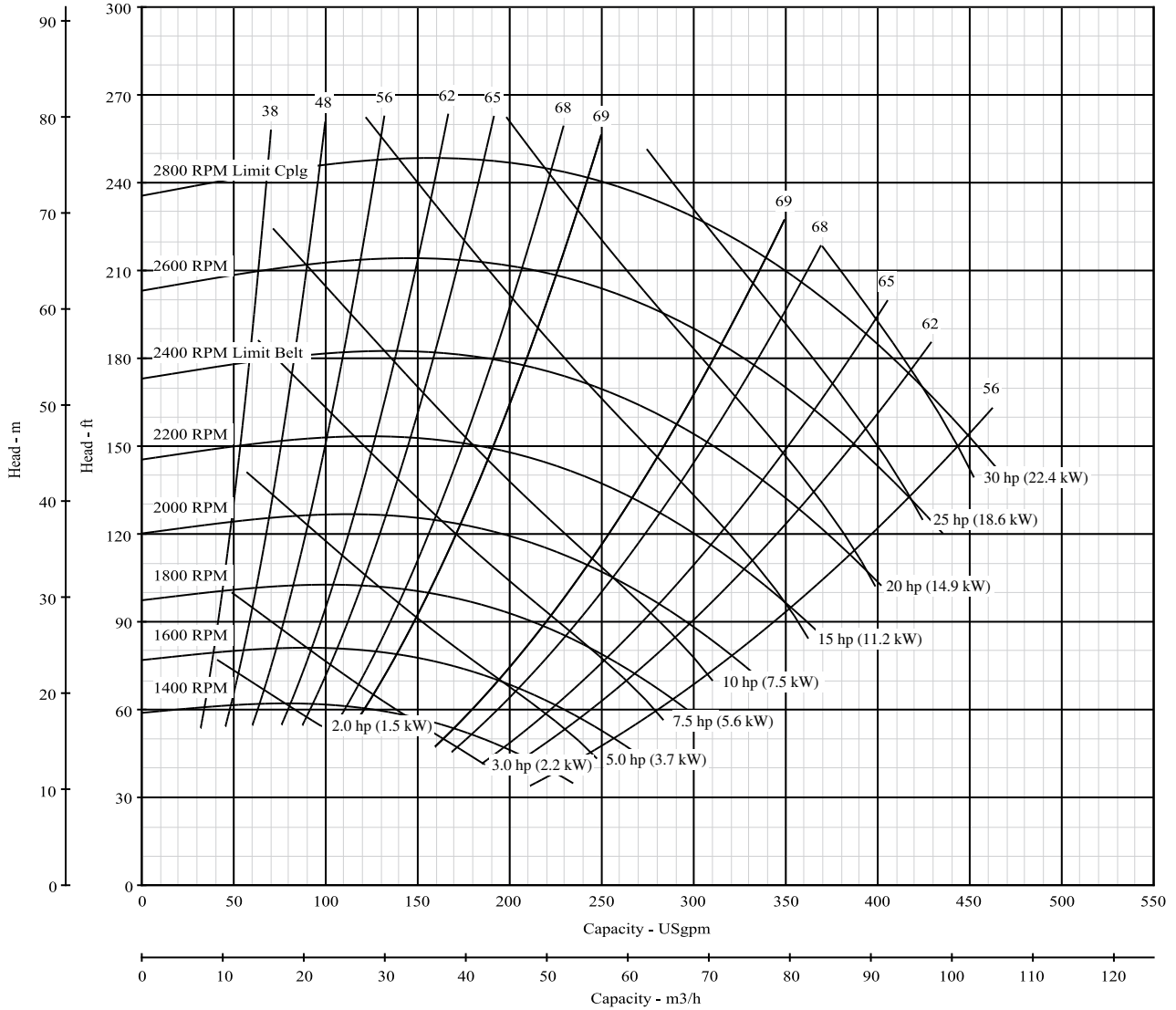

*NPSH data shown is at maximum speed

Pump Size: 2 x 3 x 10 BH

Model: B2E_BH

Curve No. 6657

Type	CCMD	FM CPLG	FM BELT	SAE	Hydraulic	AC Engine
Model		B2ERBH	B2ERBH			
RPM		1400-3200	1400-3200			

Dia. 10.44"

Nominal RPM: **VARIOUS**
 Based on Fresh Water @ 68°F (20°C)
 Maximum Working Pressure: 266 PSI (18 BAR)

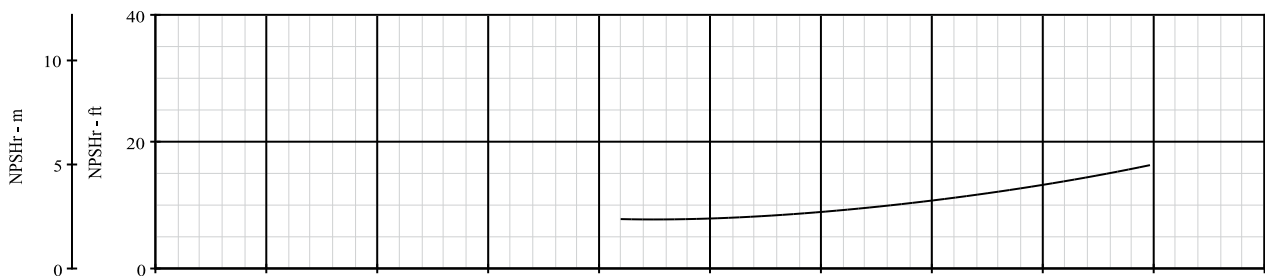
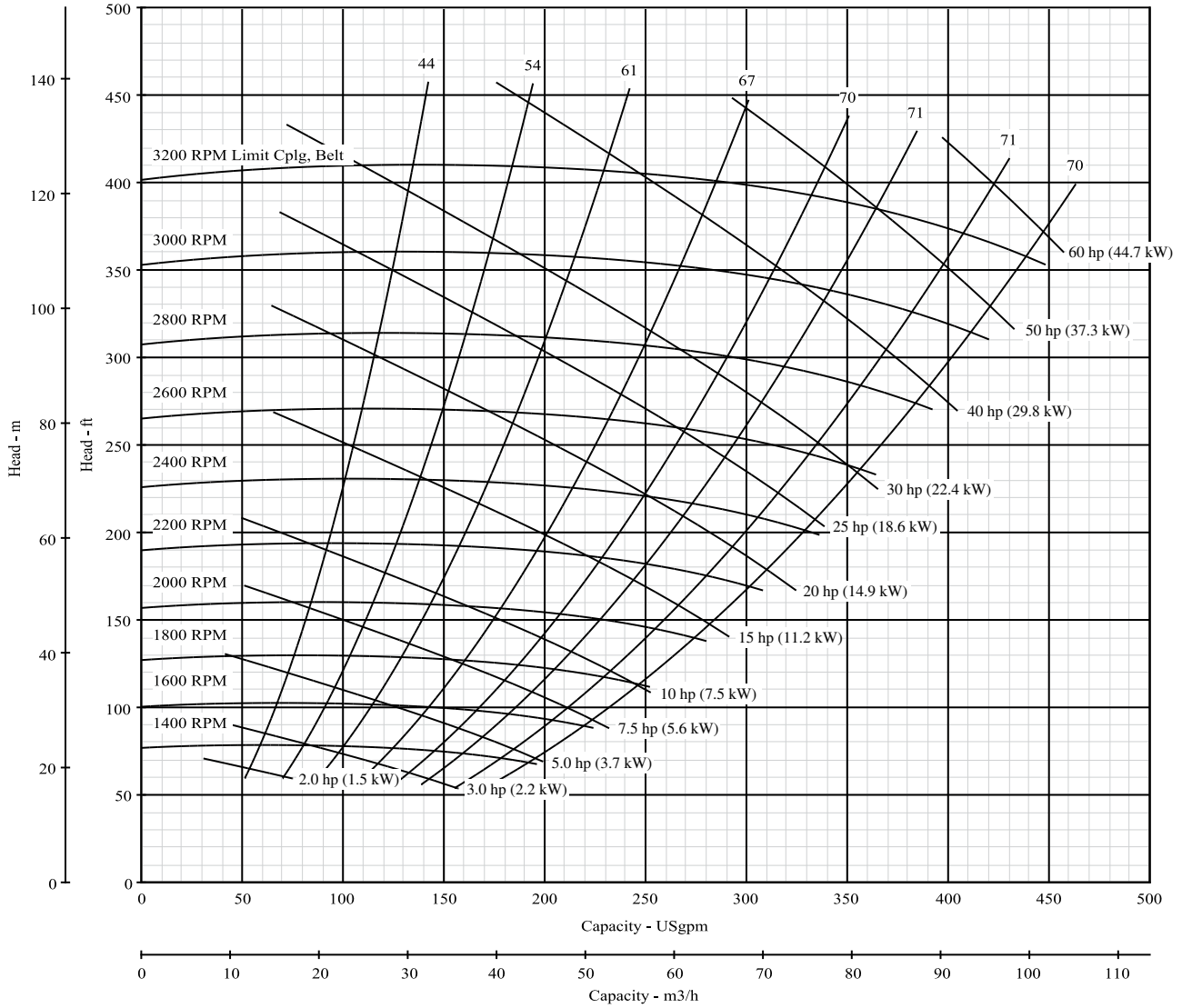

*NPSH data shown is at maximum speed

Pump Size: 2 x 3 x 10 BHH

Model: B2E_BHH

Curve No. 8671

Type	CCMD	FM CPLG	FM BELT	SAE	Hydraulic	AC Engine
Model	B2EPBHH					

Nominal RPM: **3500**
 Based on Fresh Water @ **68°F (20°C)**
 Maximum Working Pressure: **266 PSI (18 BAR)**

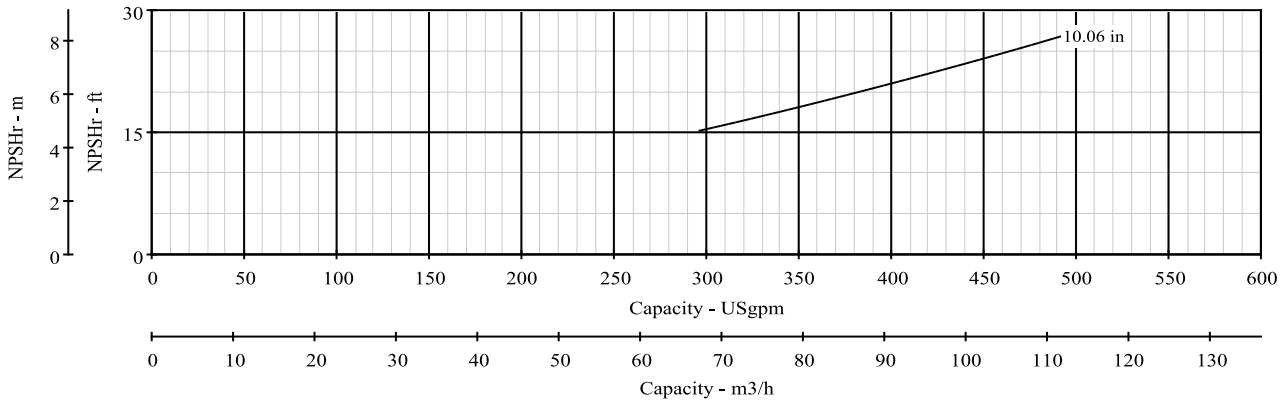
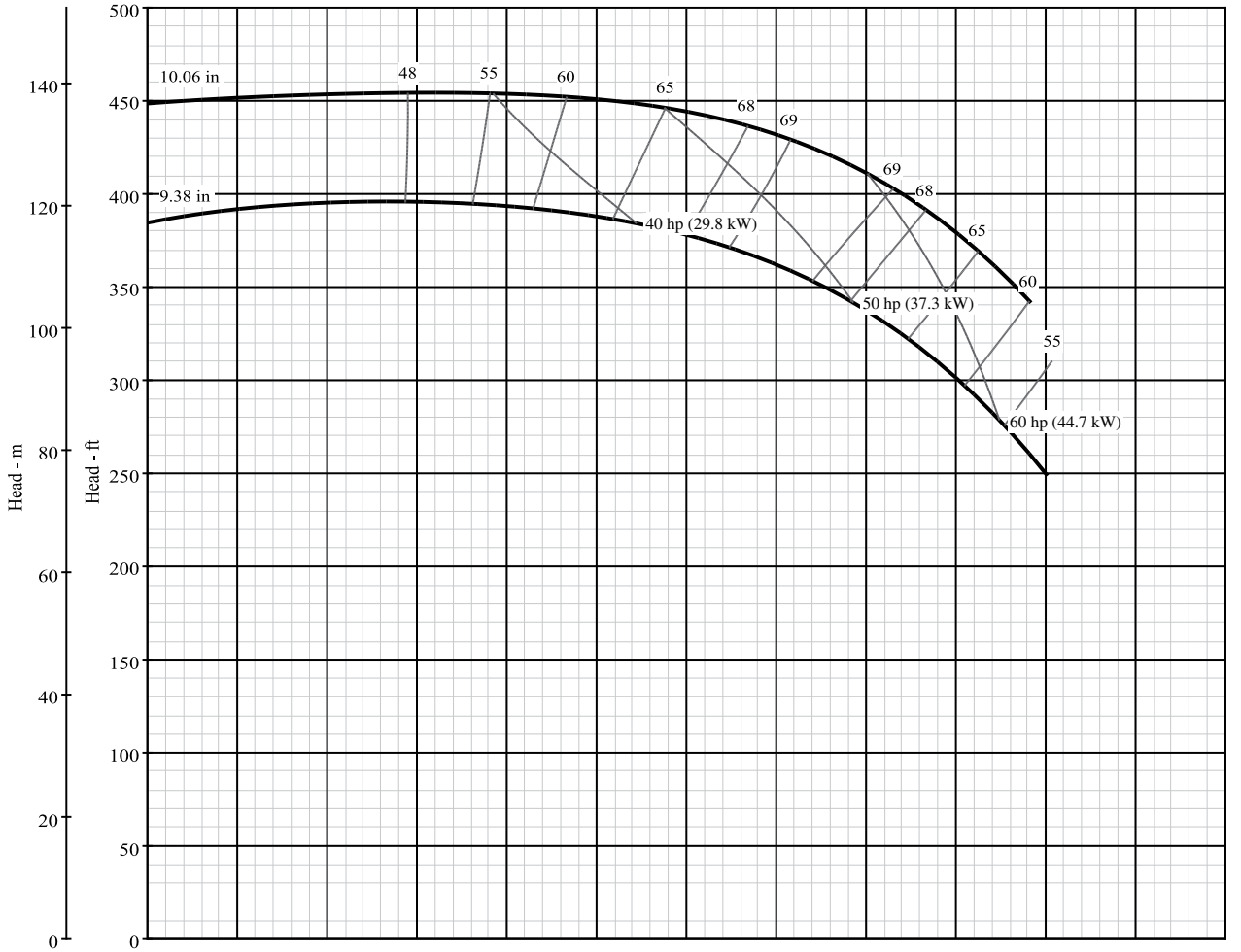

Pump Size: 2 x 3 x 10 BHH

Model: B2E_BHH

Curve No. 8671

Type	CCMD	FM CPLG	FM BELT	SAE	Hydraulic	AC Engine
Model	B2EPBHH					
RPM	1801-3600					

Dia. 10.06"

Nominal RPM: **VARIOUS**
 Based on Fresh Water @ 68°F (20°C)
 Maximum Working Pressure: 266 PSI (18 BAR)

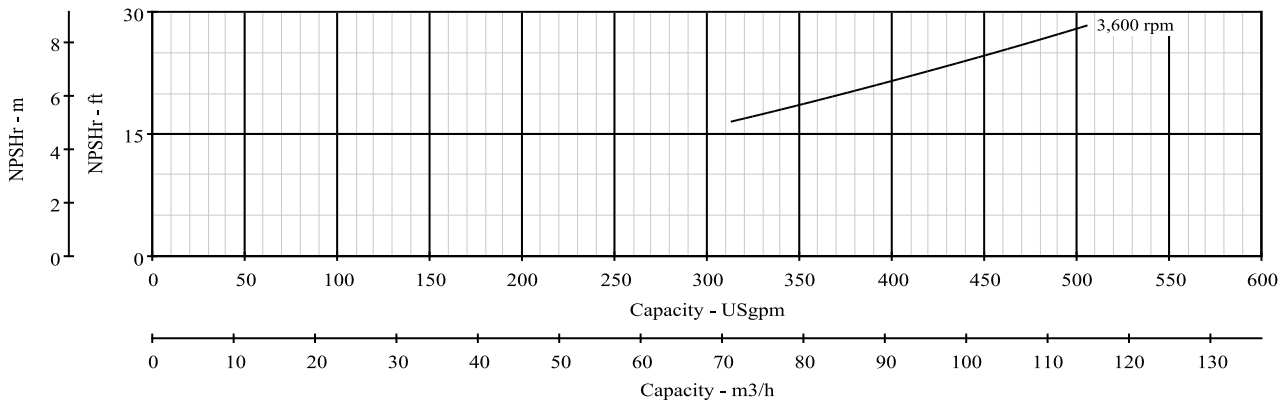
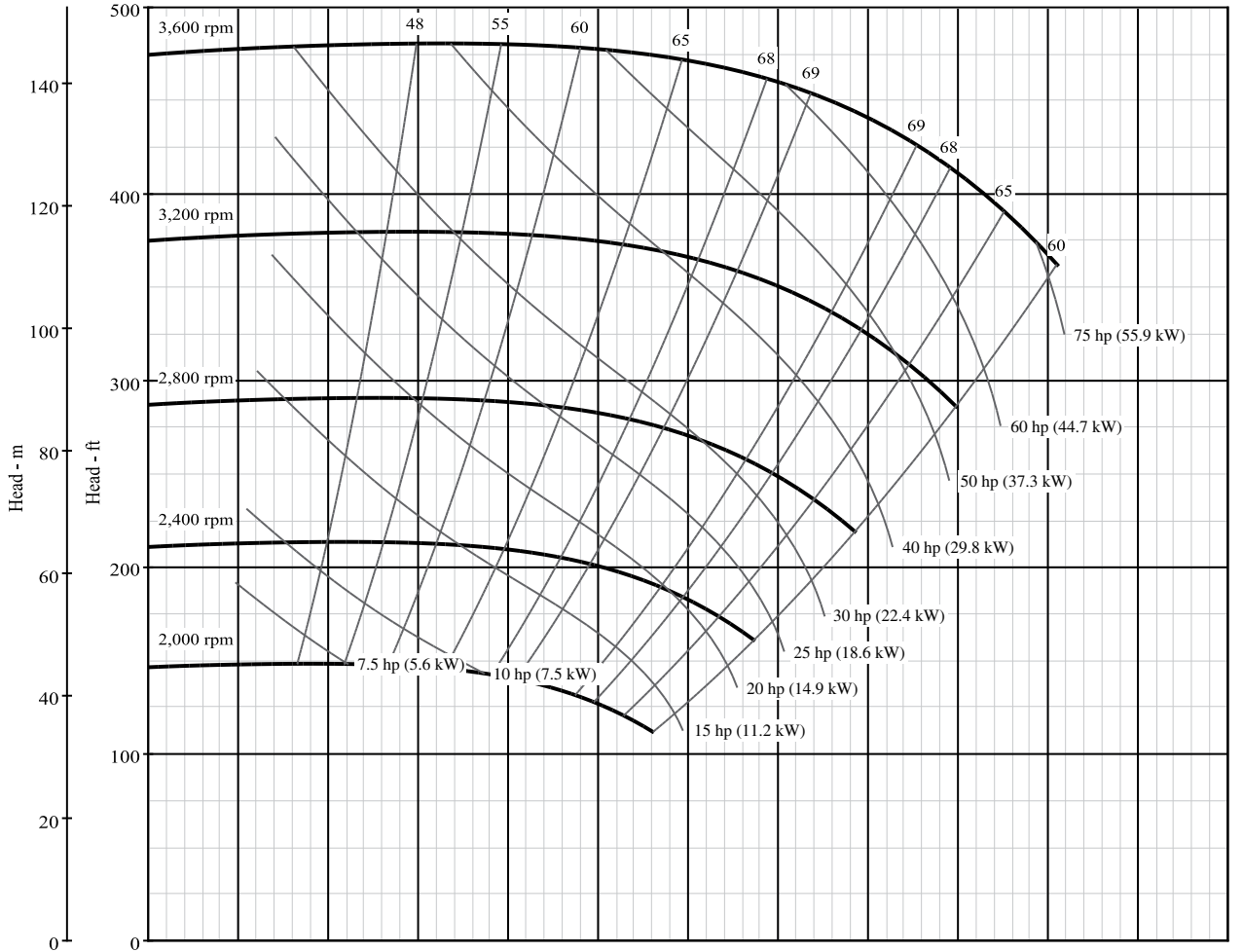

*NPSH data shown is at maximum speed

Pump Size: 2 x 3 x 10 HH

Model: B2E_HH

Curve No. 8648

Type	CCMD	FM CPLG	FM BELT	SAE	Hydraulic	AC Engine
Model		B2ERHH	B2ERHH	B2EQHH		
RPM		1400-2800	1400-2600	1600-3200		

Dia. 10.44"

Nominal RPM: **VARIOUS**
 Based on Fresh Water @ 68°F (20°C)
 Maximum Working Pressure: 266 PSI (18 BAR)

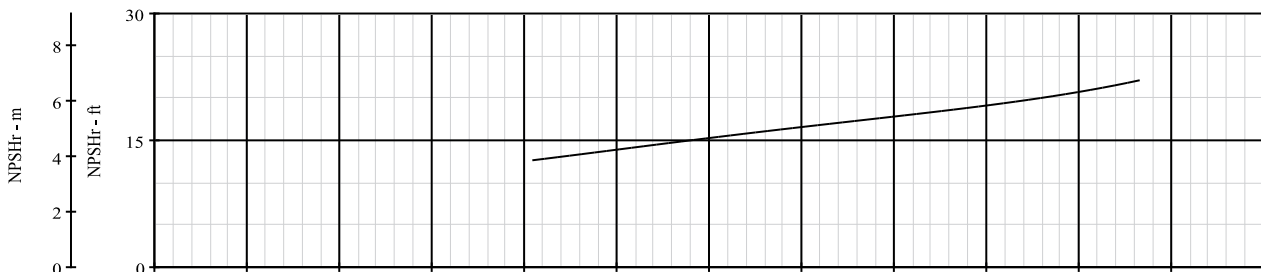
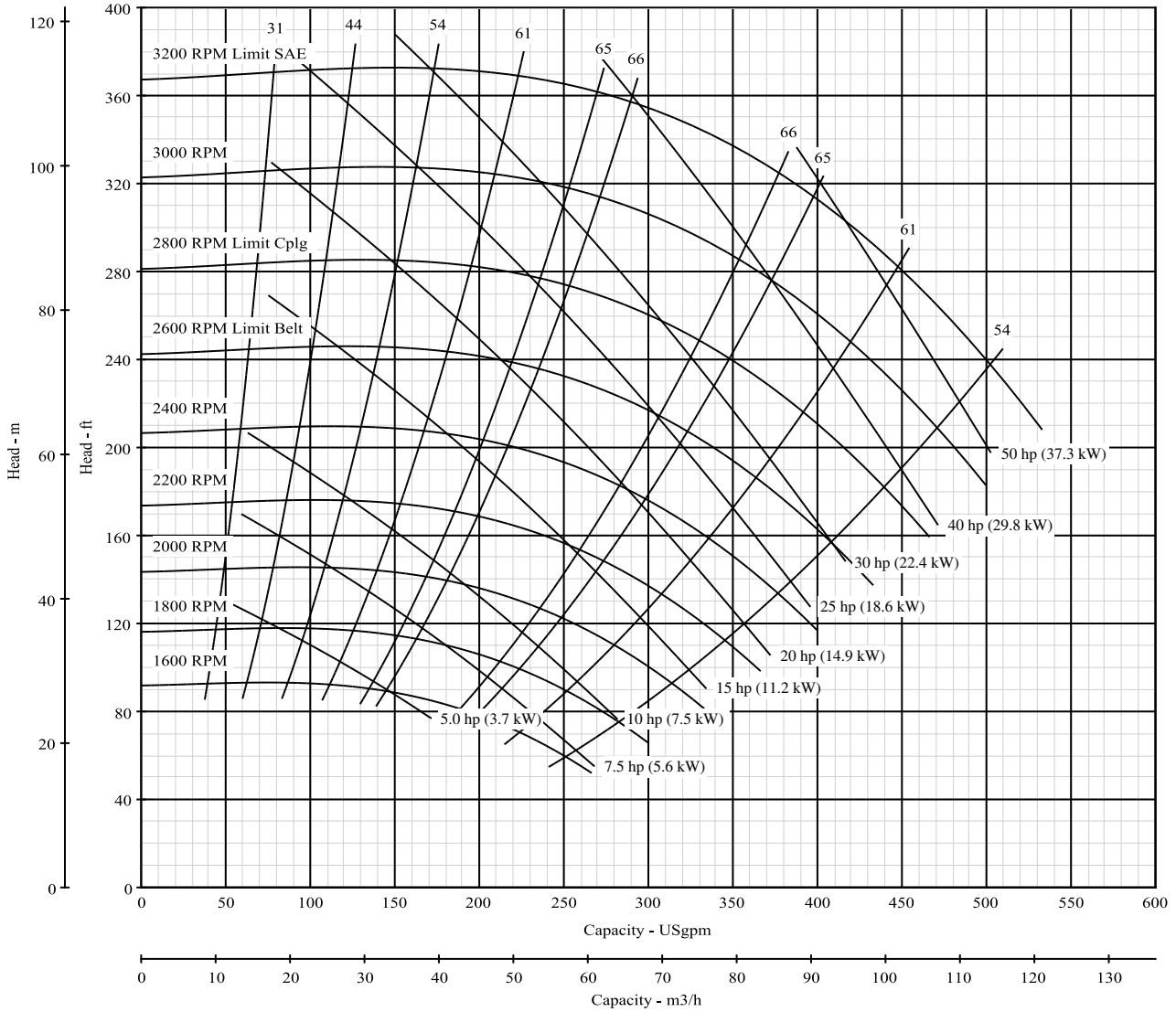

*NPSH data shown is at maximum speed

Pump Size: 3 x 4 x 10 BL

Model: B3E_BL

Curve No. 8904

Type	CCMD	FM CPLG	FM BELT	SAE	Hydraulic	AC Engine
Model	B3EPBL	B3ERBL	B3ERBL	B3EQBL		

Nominal RPM: **3500**
 Based on Fresh Water @ **68 °F (20 °C)**
 Maximum Working Pressure: **266 PSI (18 BAR)**

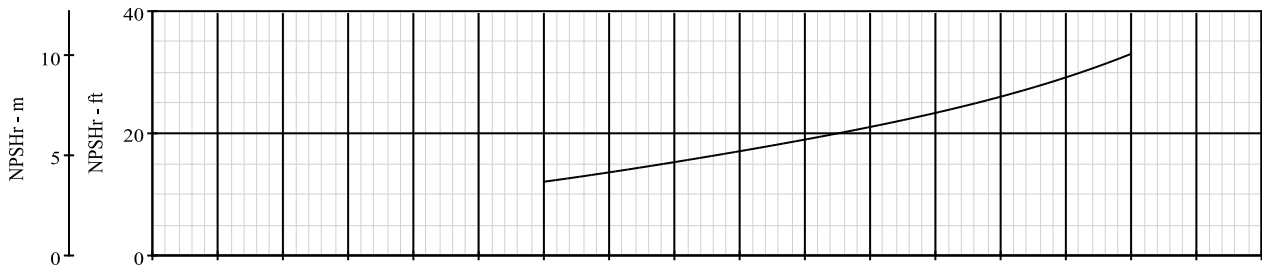
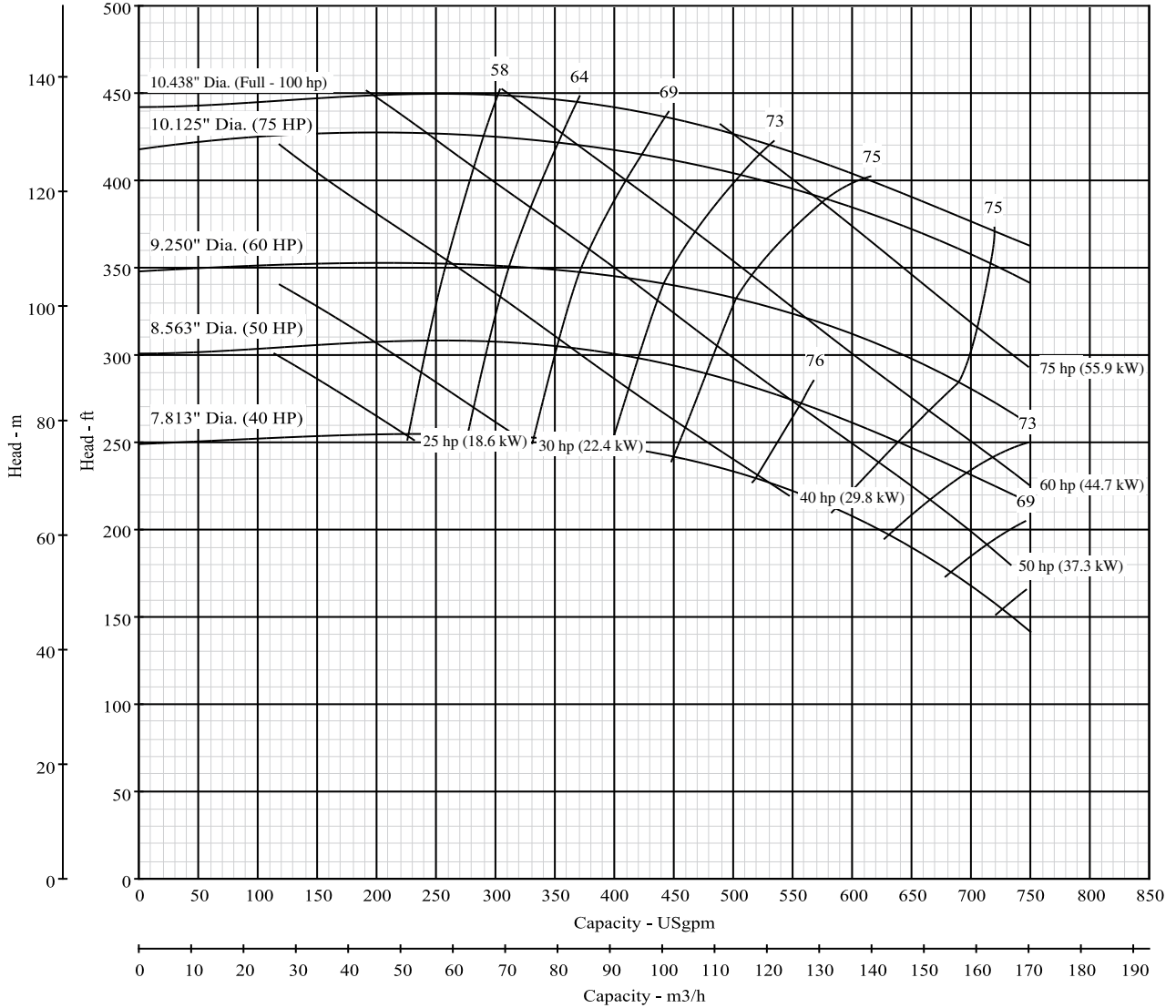

Pump Size: 3 x 4 x 10 BL

Model: B3E_BL

Curve No. 8904

Type	CCMD	FM CPLG	FM BELT	SAE	Hydraulic	AC Engine
Model	B3EPBL	B3ERBL	B3ERBL	B3EQBL		
RPM	1801-3600	1400-3500	1400-3500	1800-3500		

Dia. 10.49"

Nominal RPM: **VARIOUS**
 Based on Fresh Water @ 68°F (20°C)
 Maximum Working Pressure: 266 PSI (18 BAR)

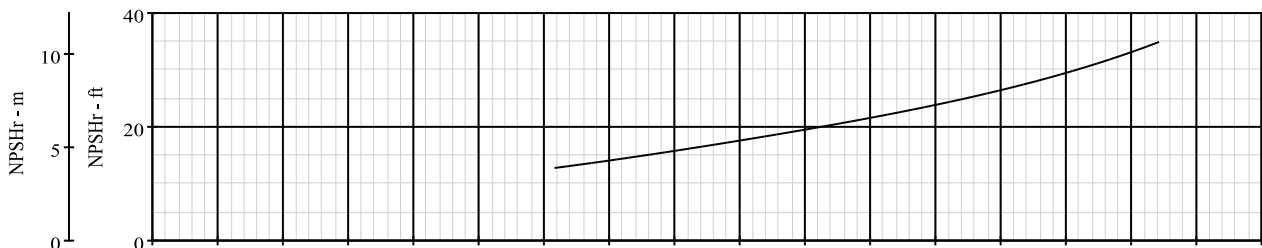
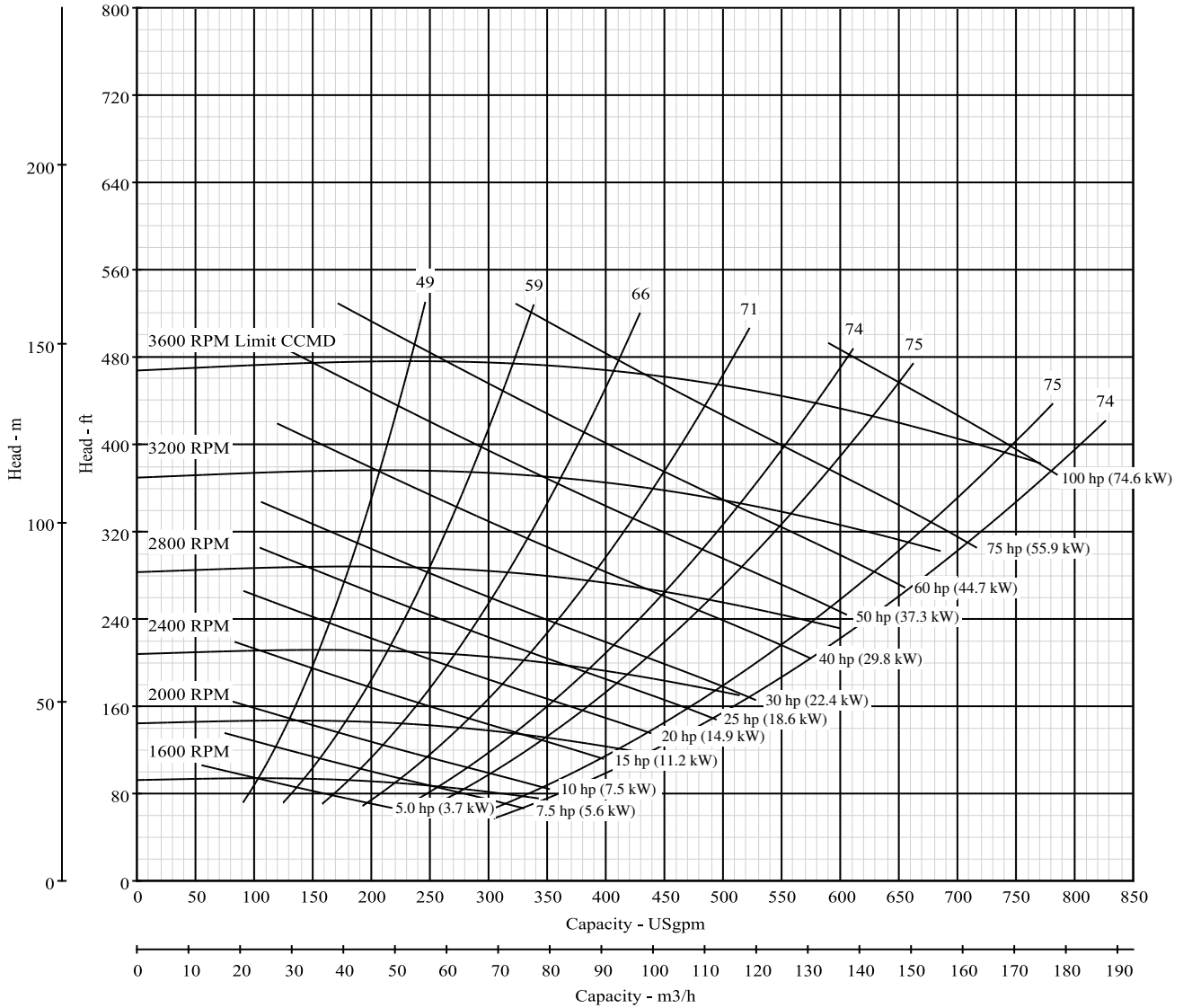

*NPSH data shown is at maximum speed

Pump Size: 3 x 4 x 10 M

Model: B3E_M

Curve No. 6545

Type	CCMD	FM CPLG	FM BELT	SAE	Hydraulic	AC Engine
Model	B3EPM	B3ERM	B3ERM			

Nominal RPM: **1740**
 Based on Fresh Water @ **68°F (20°C)**
 Maximum Working Pressure: **266 PSI (18 BAR)**

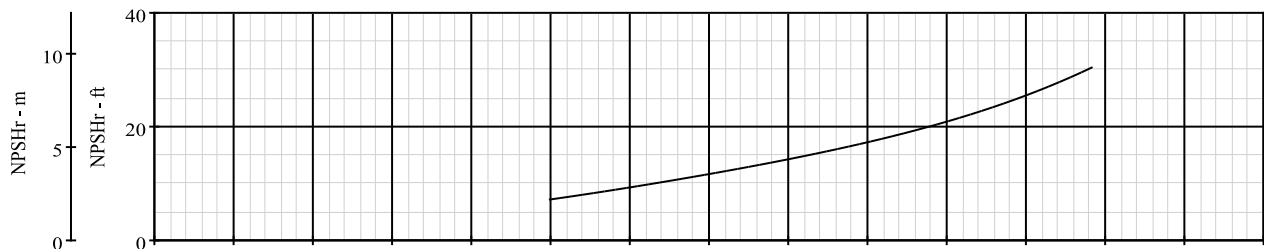
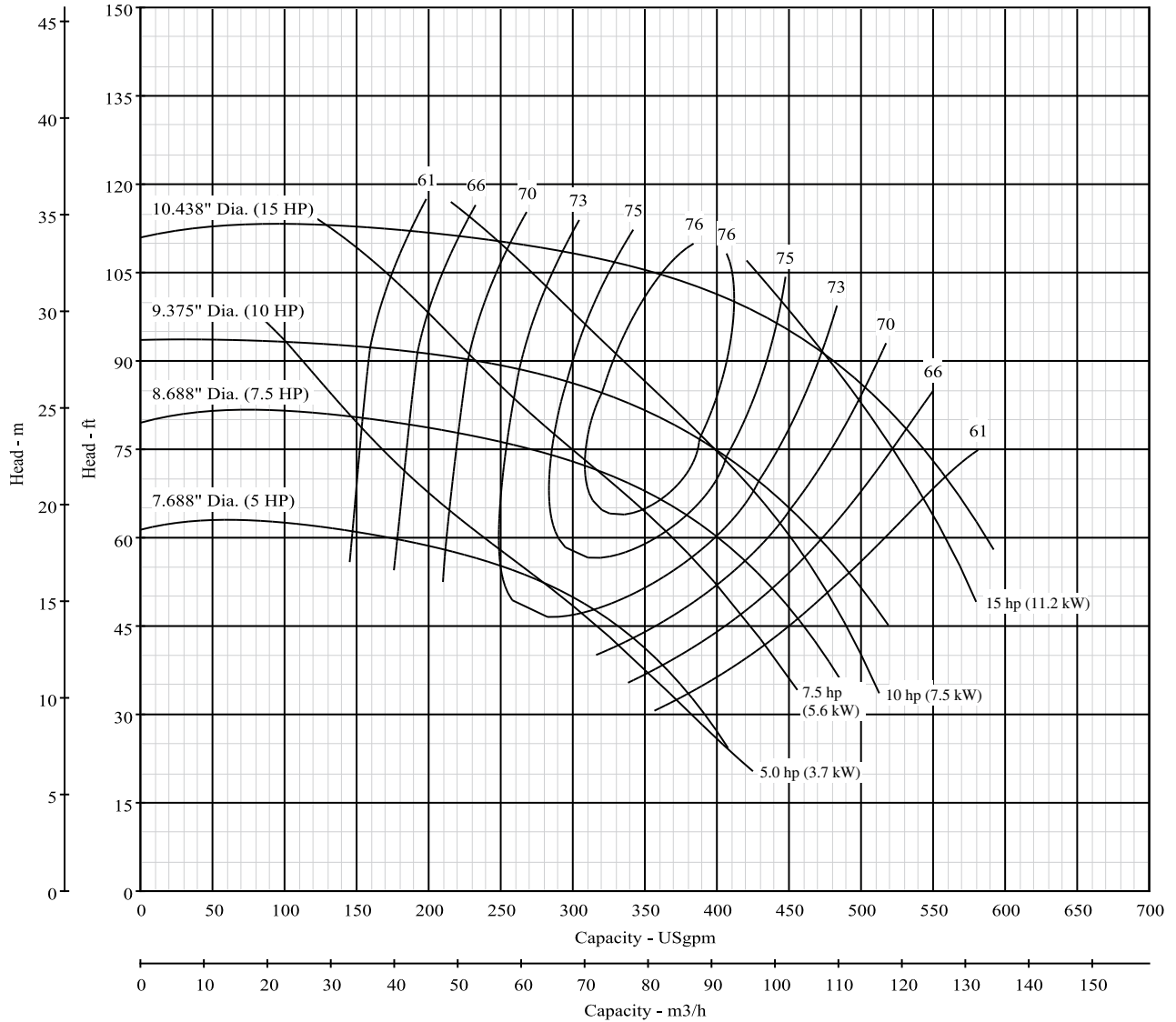

Pump Size: 3 x 4 x 10 M

Model: B3E_M

Curve No. 6545

Type	CCMD	FM CPLG	FM BELT	SAE	Hydraulic	AC Engine
Model	B3EPM	B3ERM	B3ERM			
RPM	1201-1800	1400-2200	1400-2000			

Dia. 10.44"

Nominal RPM: **VARIOUS**
 Based on Fresh Water @ 68°F (20°C)
 Maximum Working Pressure: 266 PSI (18 BAR)

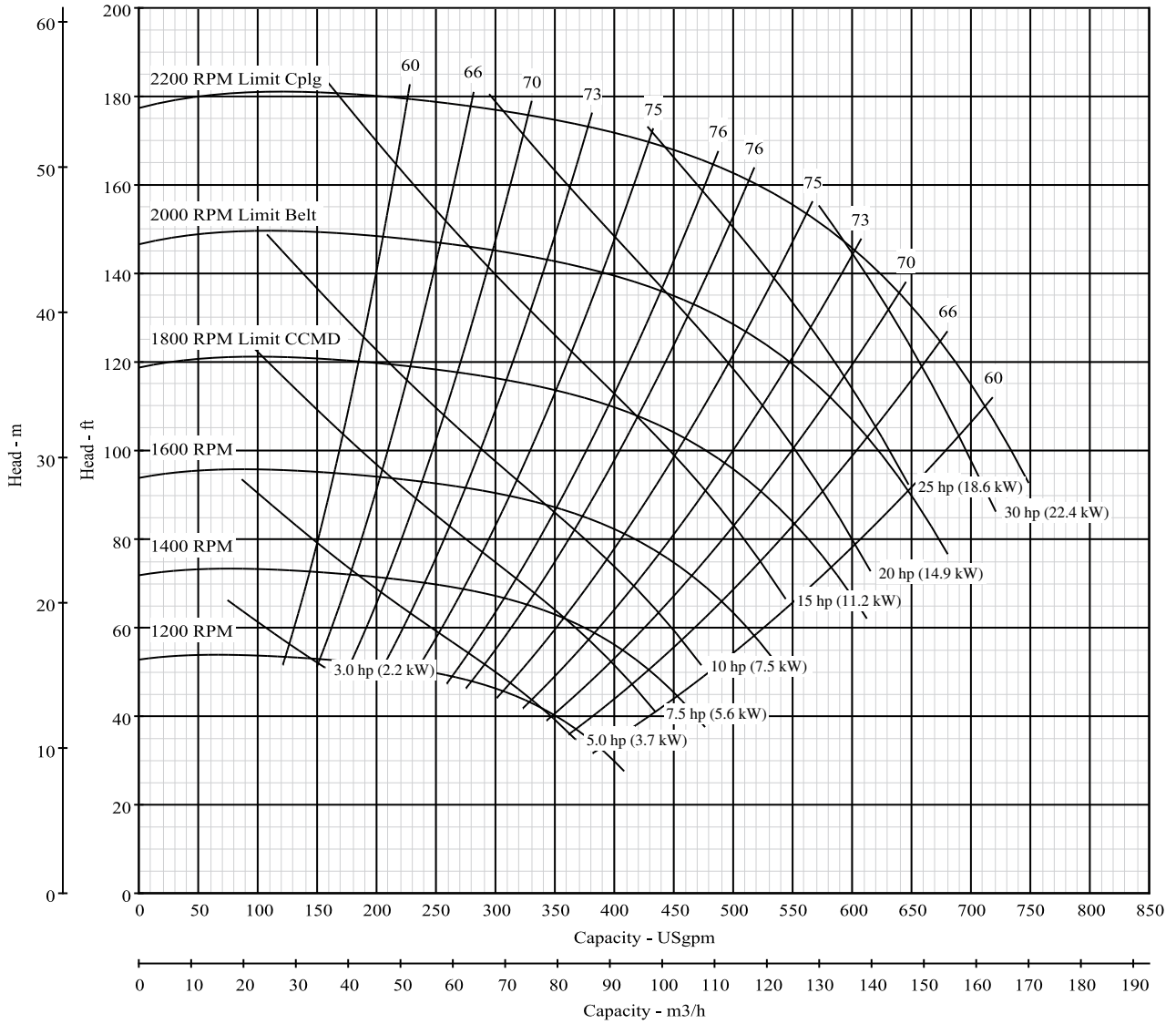

*NPSH data shown is at maximum speed

Pump Size: 4 x 5 x 10 BM

Model: B4E_BM

Curve No. 8989

Type	CCMD	FM CPLG	FM BELT	SAE	Hydraulic	AC Engine
Model	B4EPBM	B4ERBM				

Nominal RPM: **3550**
 Based on Fresh Water @ **68 °F (20 °C)**
 Maximum Working Pressure: **266 PSI (18 BAR)**

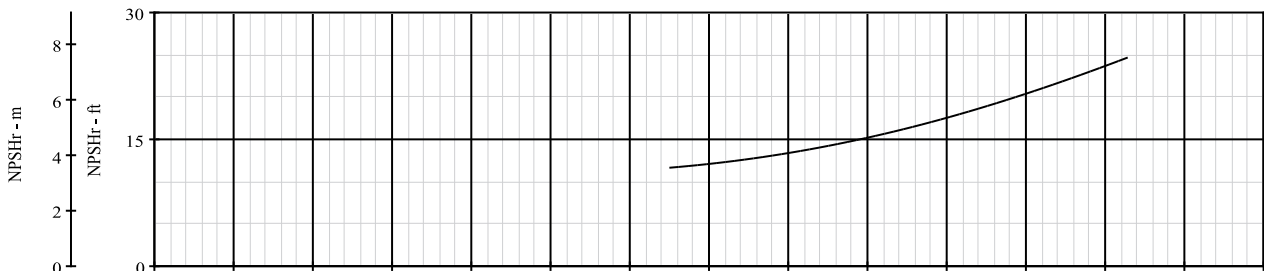
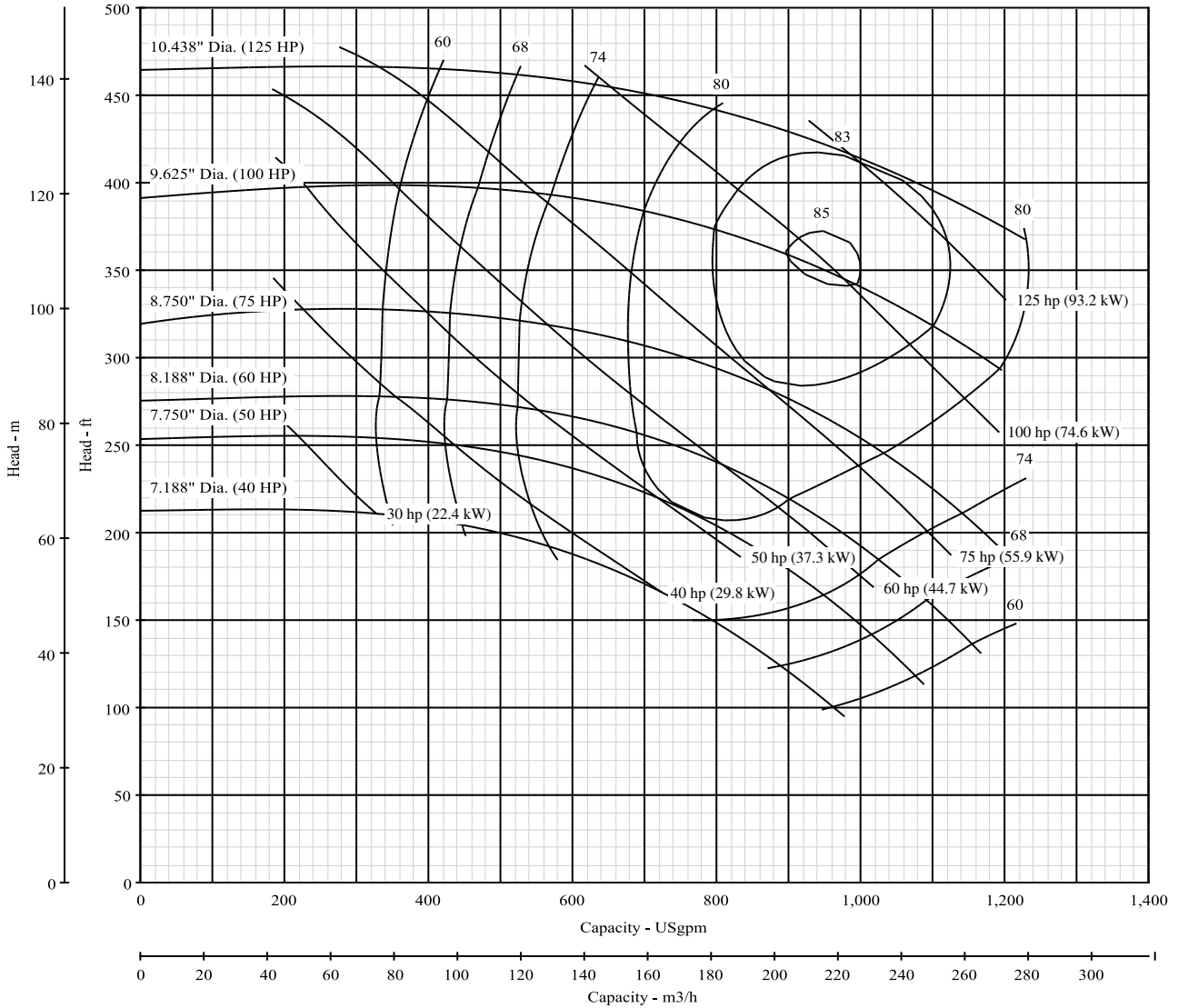

Pump Size: 4 x 5 x 10 BM

Model: B4E_BM

Curve No. 8989

Type	CCMD	FM CPLG	FM BELT	SAE	Hydraulic	AC Engine
Model	B4EPBM	B4ERBM	B4ERBM			
RPM	1801-3600	1400-3600	1400-2800			

Dia. 10.44"

Nominal RPM: **VARIOUS**
 Based on Fresh Water @ 68°F (20°C)
 Maximum Working Pressure: 266 PSI (18 BAR)

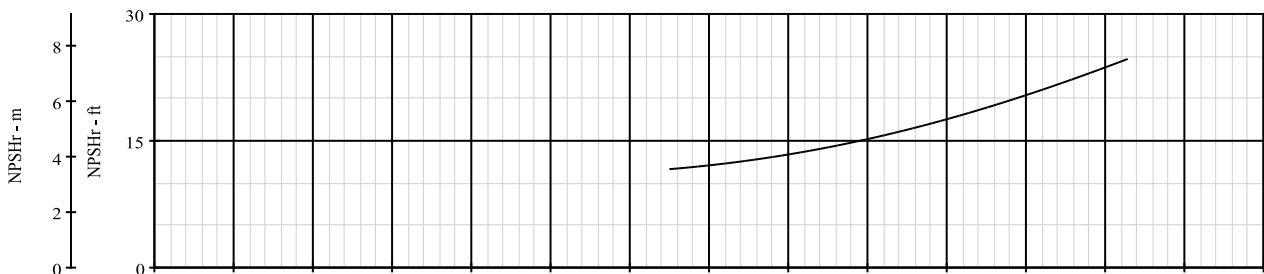
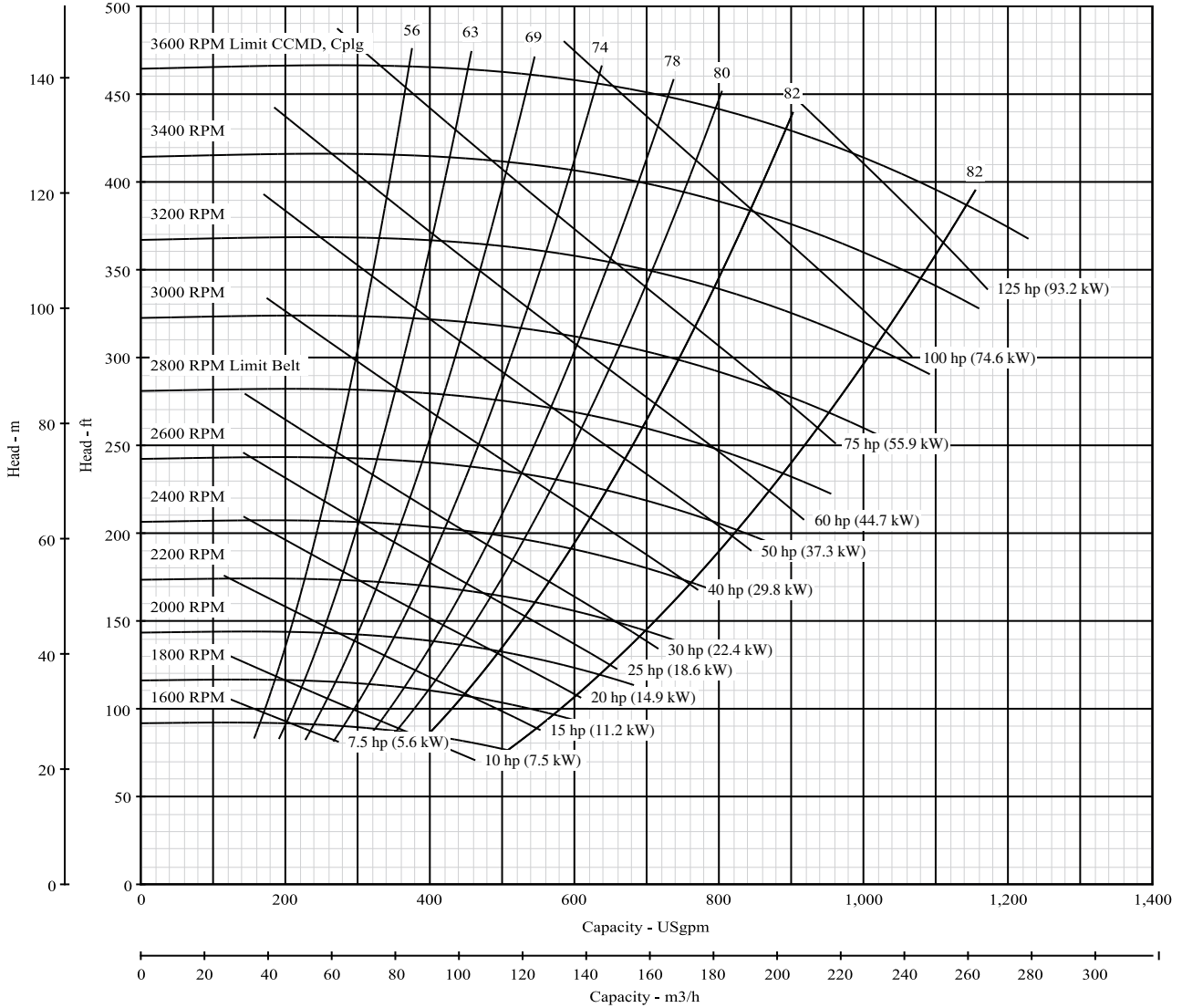

*NPSH data shown is at maximum speed

Pump Size: 4 x 5 x 10 M

Model: B4E_M

Curve No. 6425

Type	CCMD	FM CPLG	FM BELT	SAE	Hydraulic	AC Engine
Model	B4EPM	B4ERM	B4ERM	B4EQM		

Nominal RPM: **1750**
 Based on Fresh Water @ **68°F (20°C)**
 Maximum Working Pressure: **266 PSI (18 BAR)**

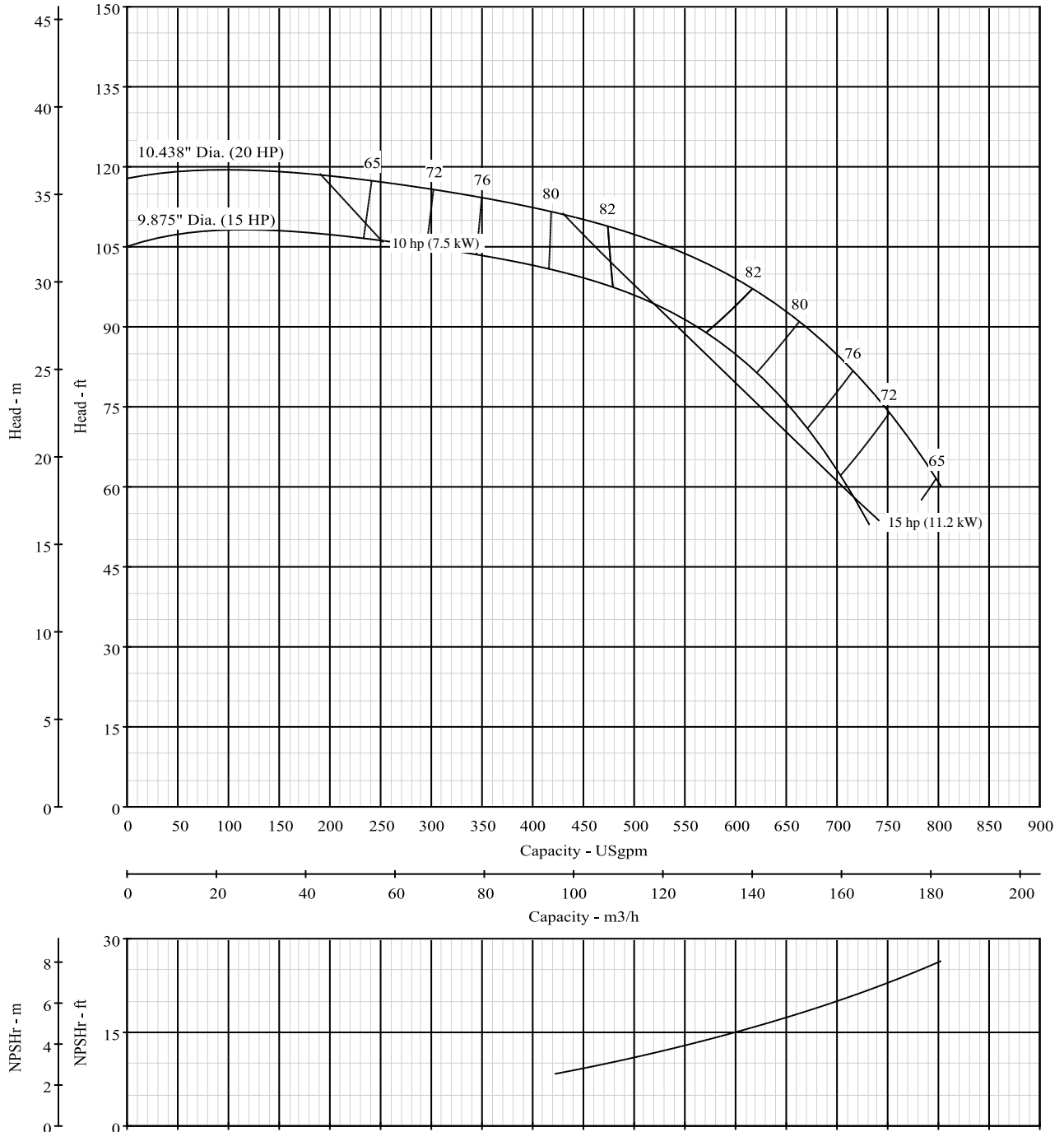

Pump Size: 4 x 5 x 10 M

Model: B4E_M

Curve No. 6425

Type	CCMD	FM CPLG	FM BELT	SAE	Hydraulic	AC Engine
Model	B4EPM	B4ERM	B4ERM	B4EQM		
RPM	1201-1800	1400-2000	1400-1800	1800-3100		

Dia. 10.44"

Nominal RPM: **VARIOUS**
 Based on Fresh Water @ 68°F (20°C)
 Maximum Working Pressure: 266 PSI (18 BAR)

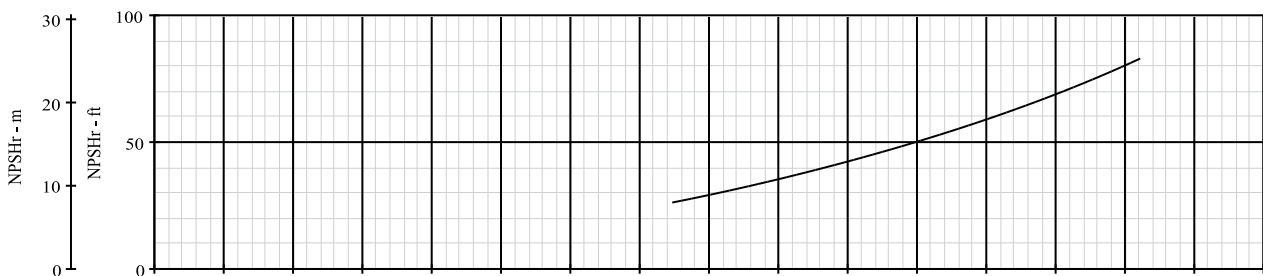
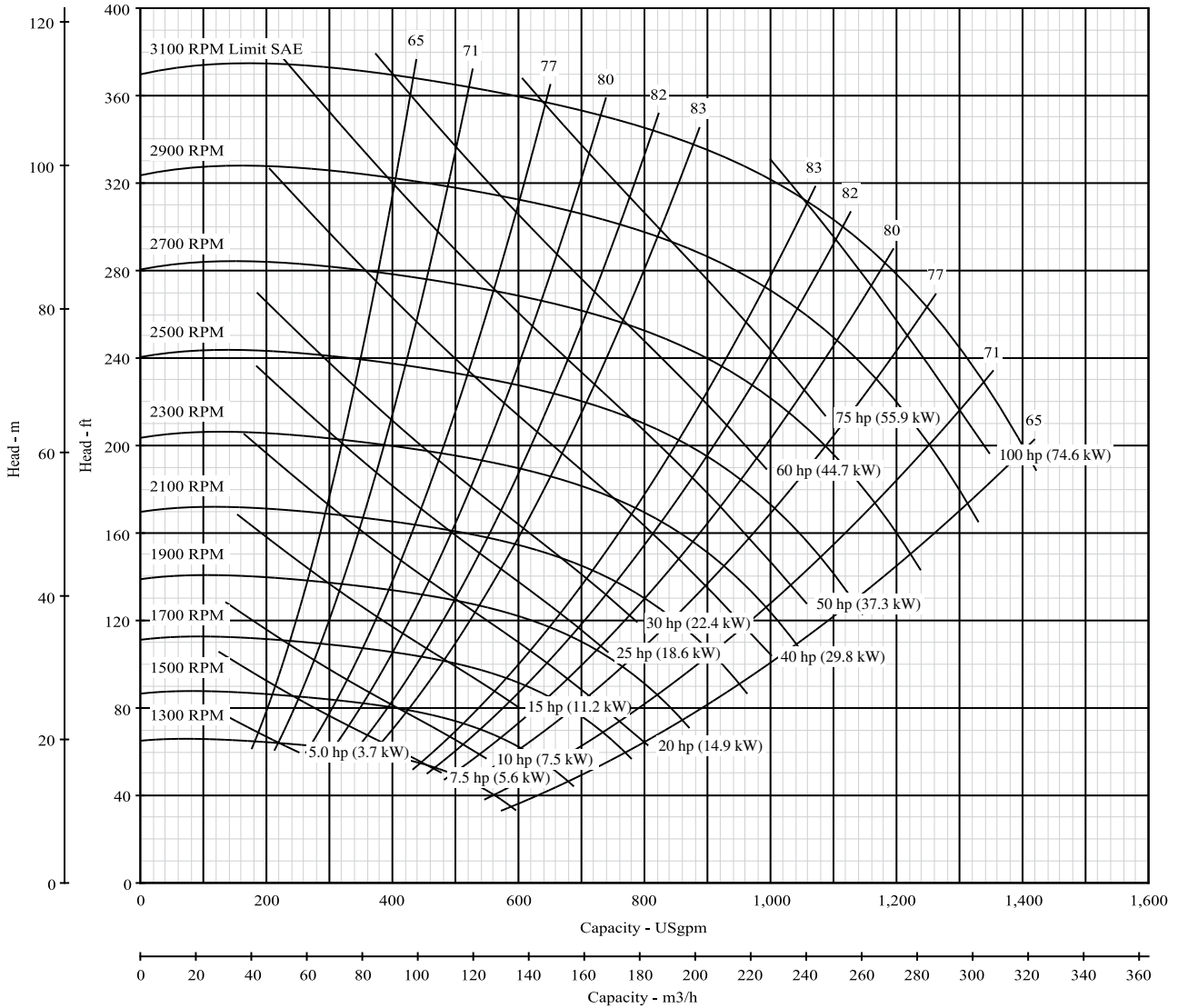

*NPSH data shown is at maximum speed

Pump Size: 5 x 6 x 10 BM

Model: B5E_BM

Curve No. 8726

Type	CCMD	FM CPLG	FM BELT	SAE	Hydraulic	AC Engine
Model	B5EPBM					

Nominal RPM: **3550**
 Based on Fresh Water @ **68°F (20°C)**
 Maximum Working Pressure: **266 PSI (18 BAR)**

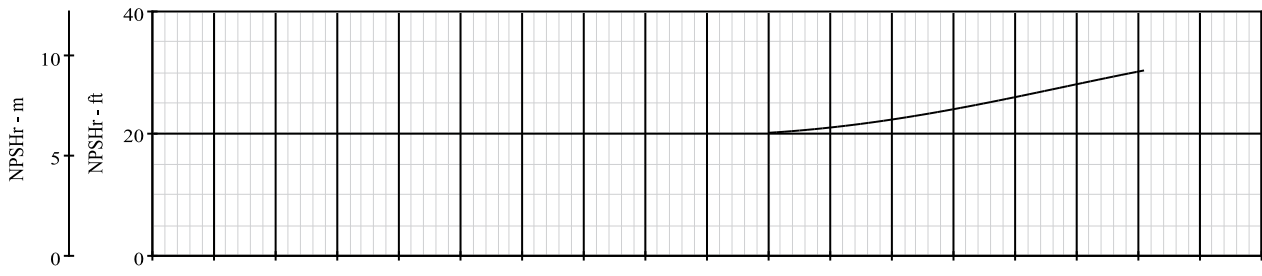
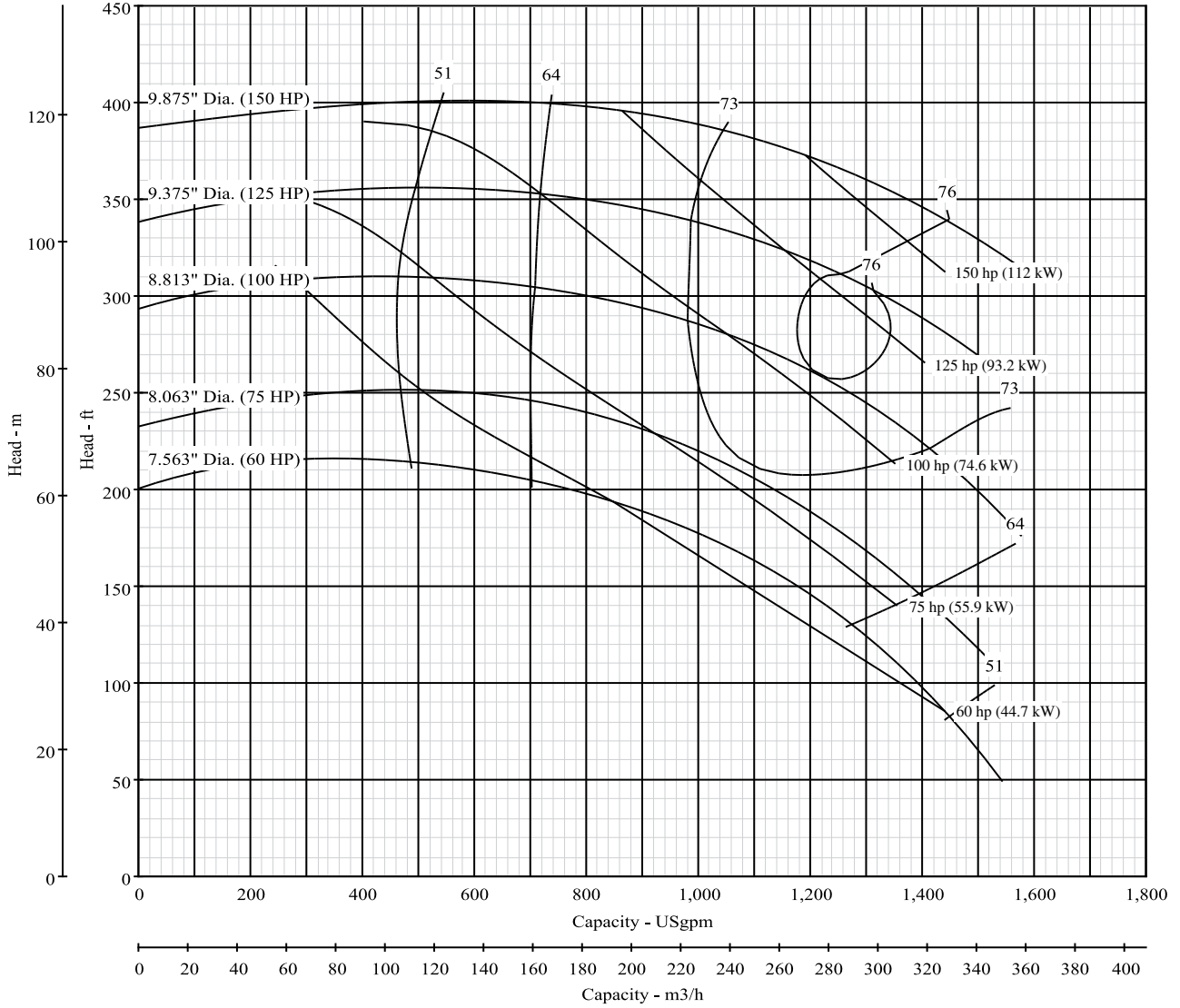

Pump Size: 5 x 6 x 10 BM

Model: B5E_BM

Curve No. 8726

Type	CCMD	FM CPLG	FM BELT	SAE	Hydraulic	AC Engine
Model	B5EPBM					
RPM	1801-3600					

Dia. 9.88"

Nominal RPM: **VARIOUS**
 Based on Fresh Water @ 68°F (20°C)
 Maximum Working Pressure: 266 PSI (18 BAR)

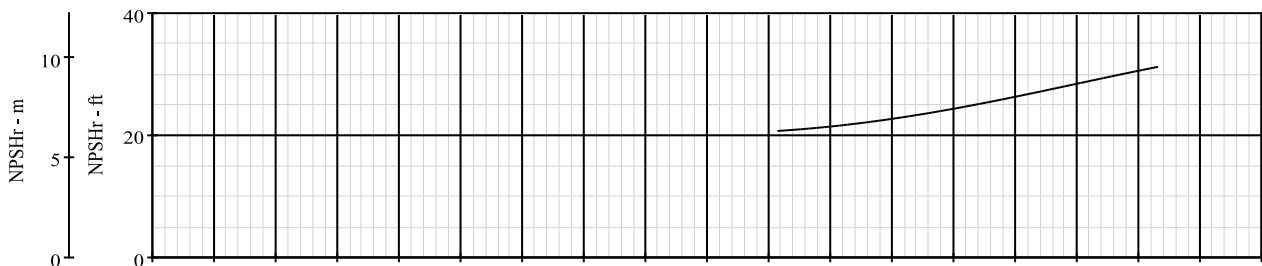
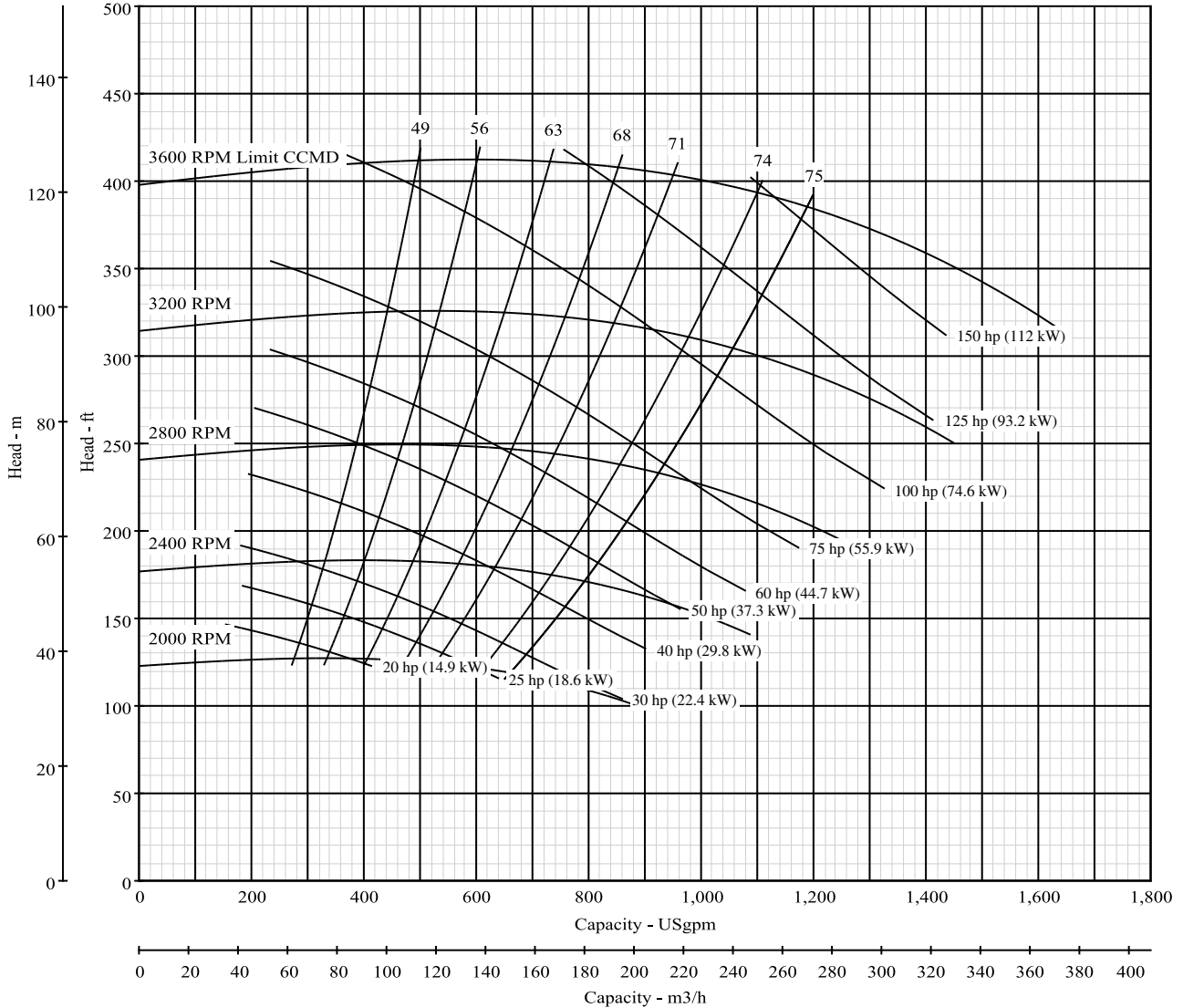

*NPSH data shown is at maximum speed

Pump Size: 5 x 6 x 10 H

Model: B5E_H

Curve No. 7801

Type	CCMD	FM CPLG	FM BELT	SAE	Hydraulic	AC Engine
Model	B5EPH	B5ERH	B5ERH			

Nominal RPM: **1750**
 Based on Fresh Water @ **68°F (20°C)**
 Maximum Working Pressure: **266 PSI (18 BAR)**

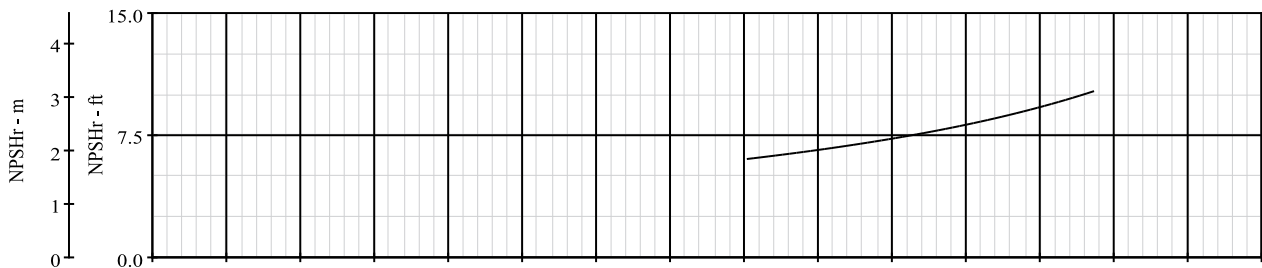
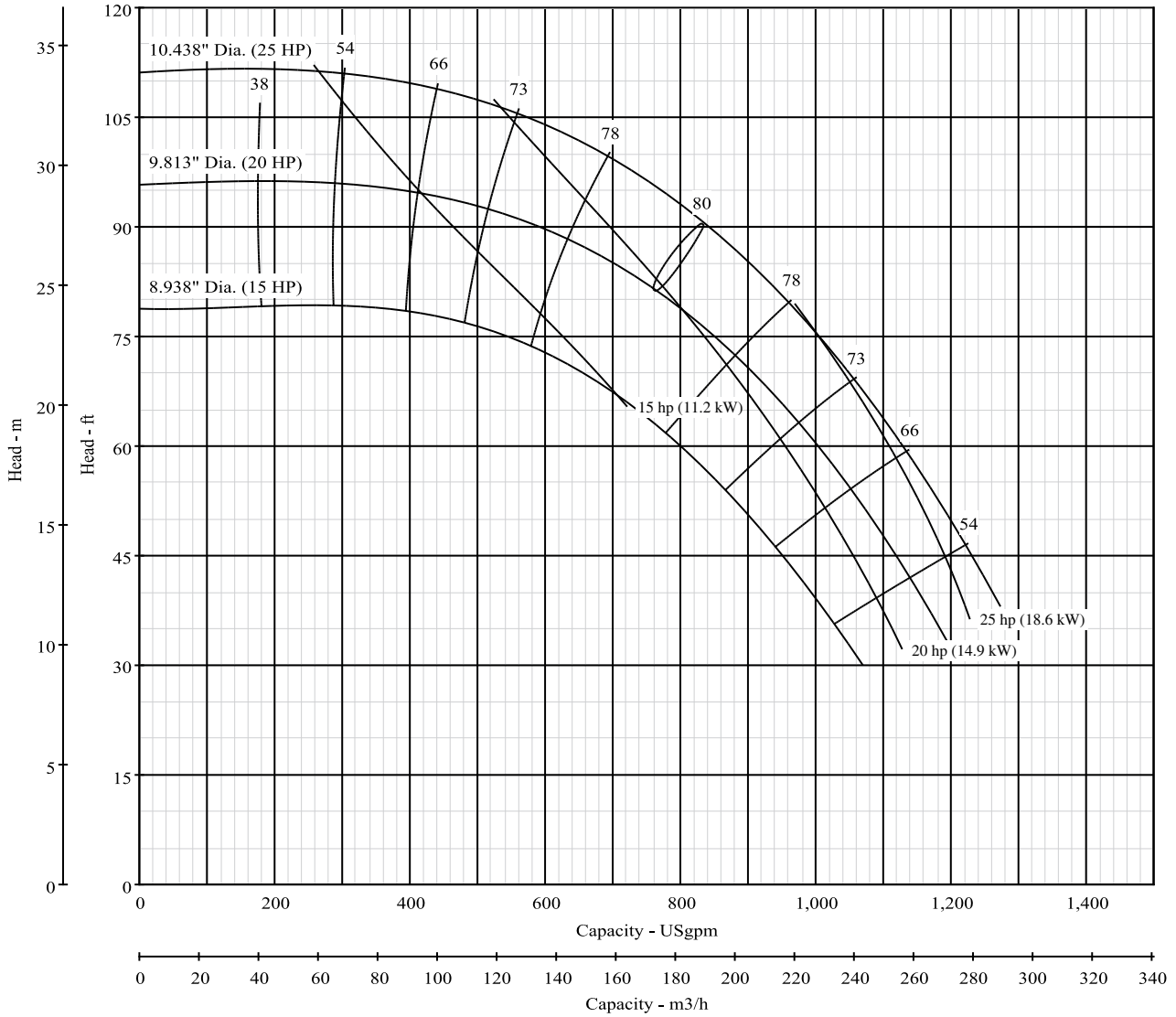

Pump Size: 5 x 6 x 10 H

Model: B5E_H

Curve No. 7801

Type	CCMD	FM CPLG	FM BELT	SAE	Hydraulic	AC Engine
Model	B5EPH	B5ERH	B5ERH			
RPM	1201-1800	1400-2000	1400-1800			

Dia. 10.44"

Nominal RPM: **VARIOUS**
 Based on Fresh Water @ 68°F (20°C)
 Maximum Working Pressure: 266 PSI (18 BAR)

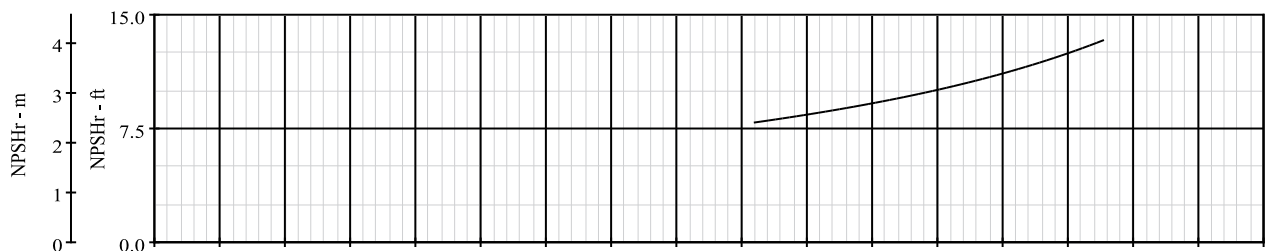
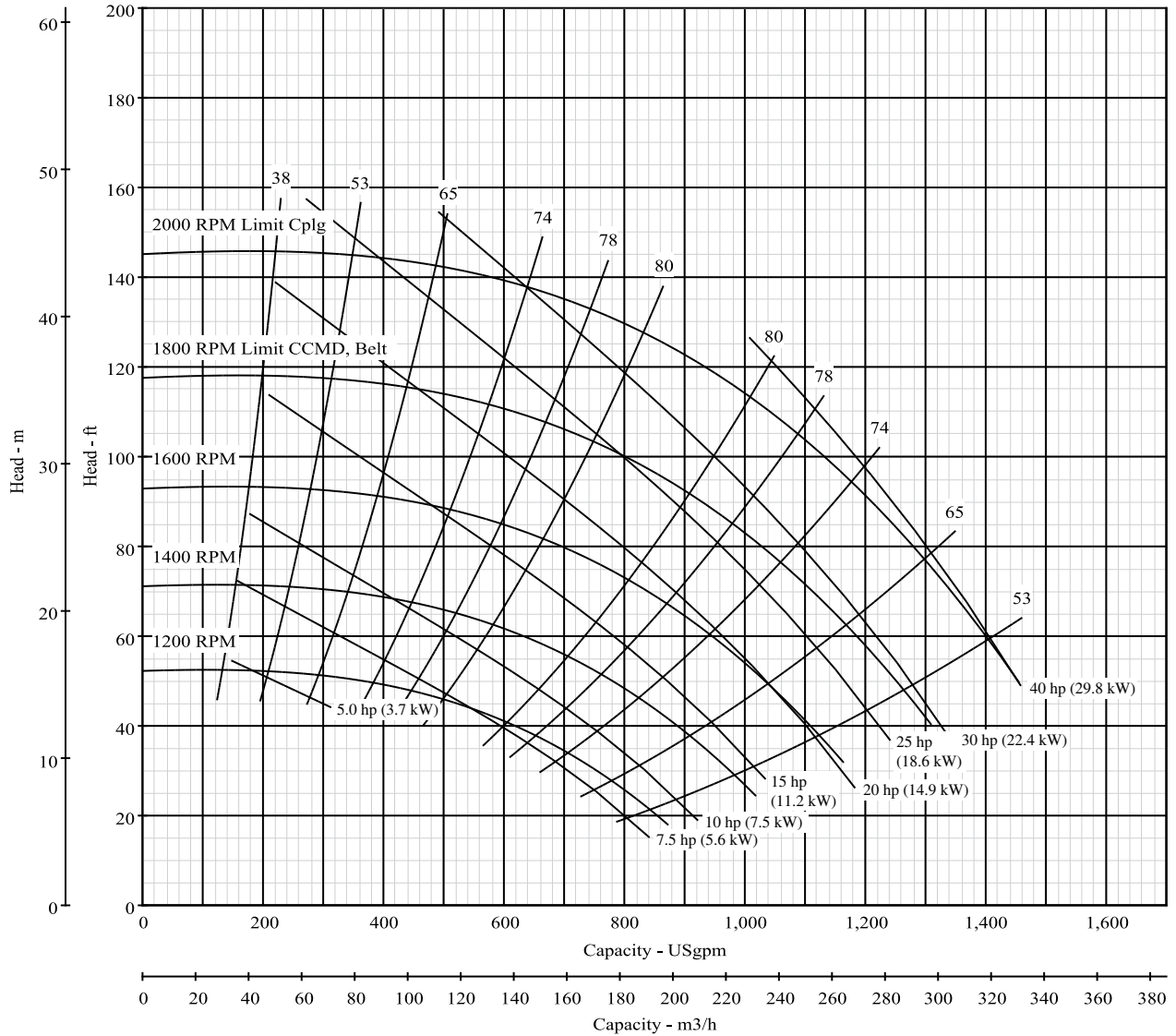

*NPSH data shown is at maximum speed

Pump Size: 5 x 6 x 10 H

Model: B5E_BH

Curve No. 7801A

Type	CCMD	FM CPLG	FM BELT	SAE	Hydraulic	AC Engine
Model				B5EQBH		
RPM				1600-2900		

Dia. 10.44"

Nominal RPM: **VARIOUS**
 Based on Fresh Water @ 68°F (20°C)
 Maximum Working Pressure: 266 PSI (18 BAR)

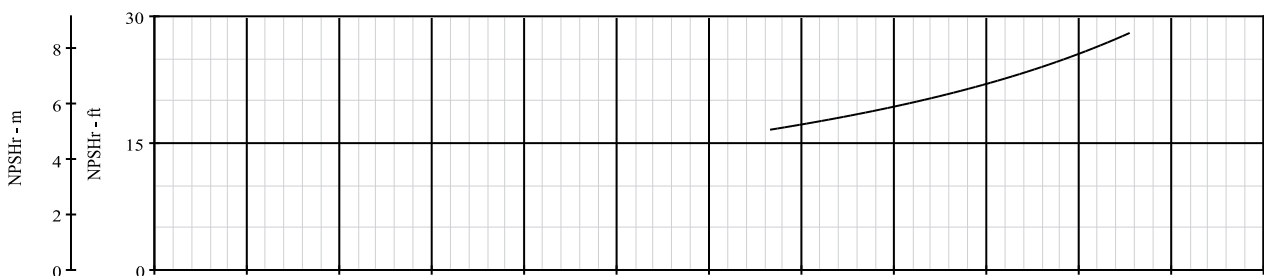
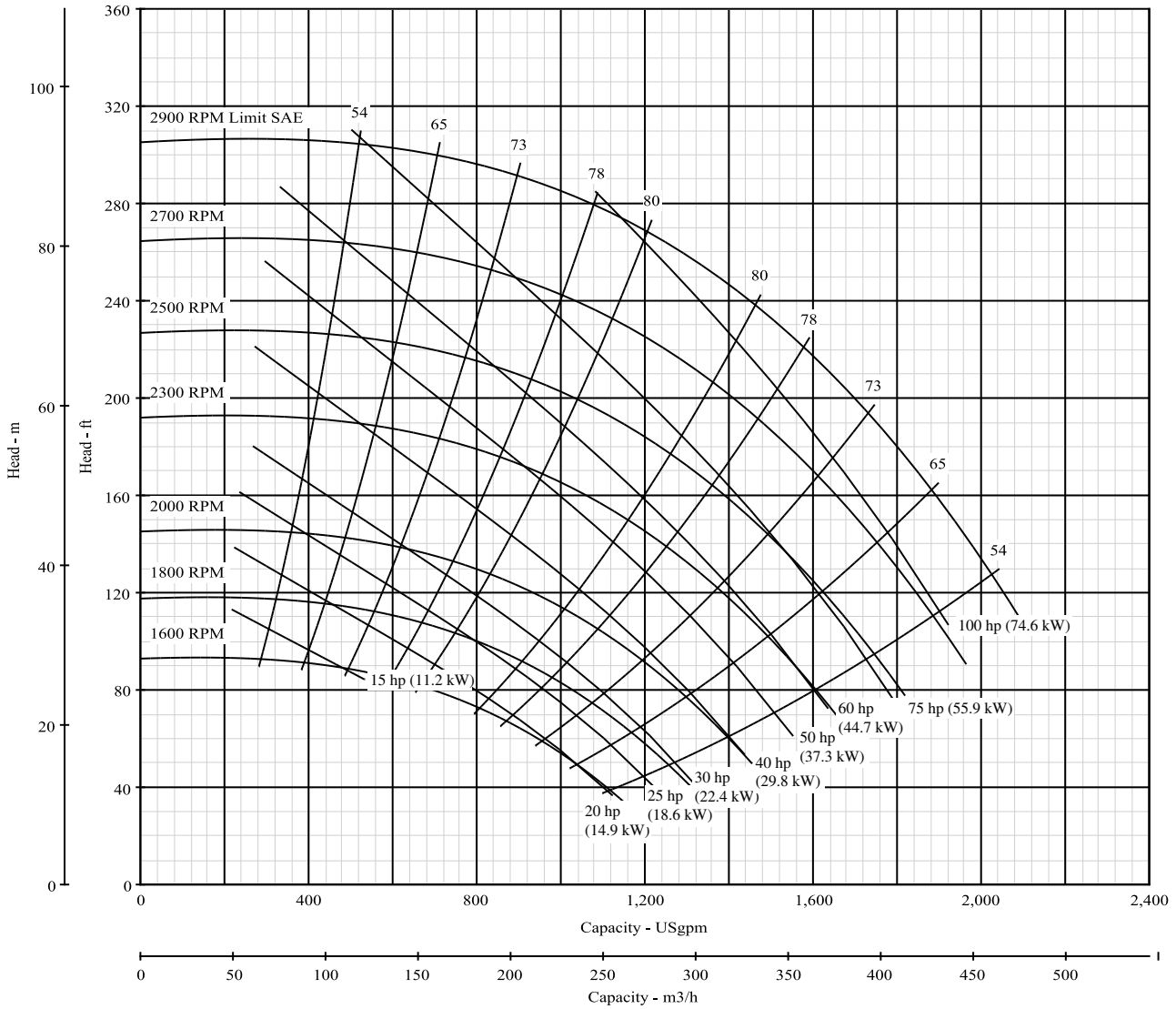

*NPSH data shown is at maximum speed

Pump Size: 4 x 5 x 12 BH

Model: B4G_BH

Curve No. 1234

Type	CCMD	FM CPLG	FM BELT	SAE	Hydraulic	AC Engine
Model	B4GPBH	B4GRMBH	B4GRMBH	B4GQBH		

Nominal RPM: **1750**
 Based on Fresh Water @ **68°F (20°C)**
 Maximum Working Pressure: 266 PSI (18 BAR)

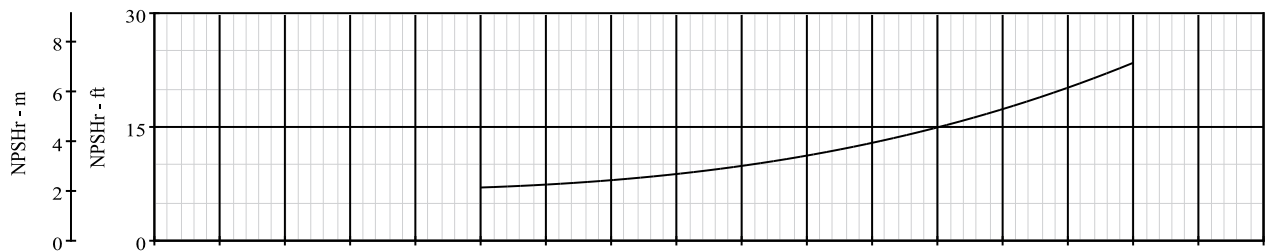
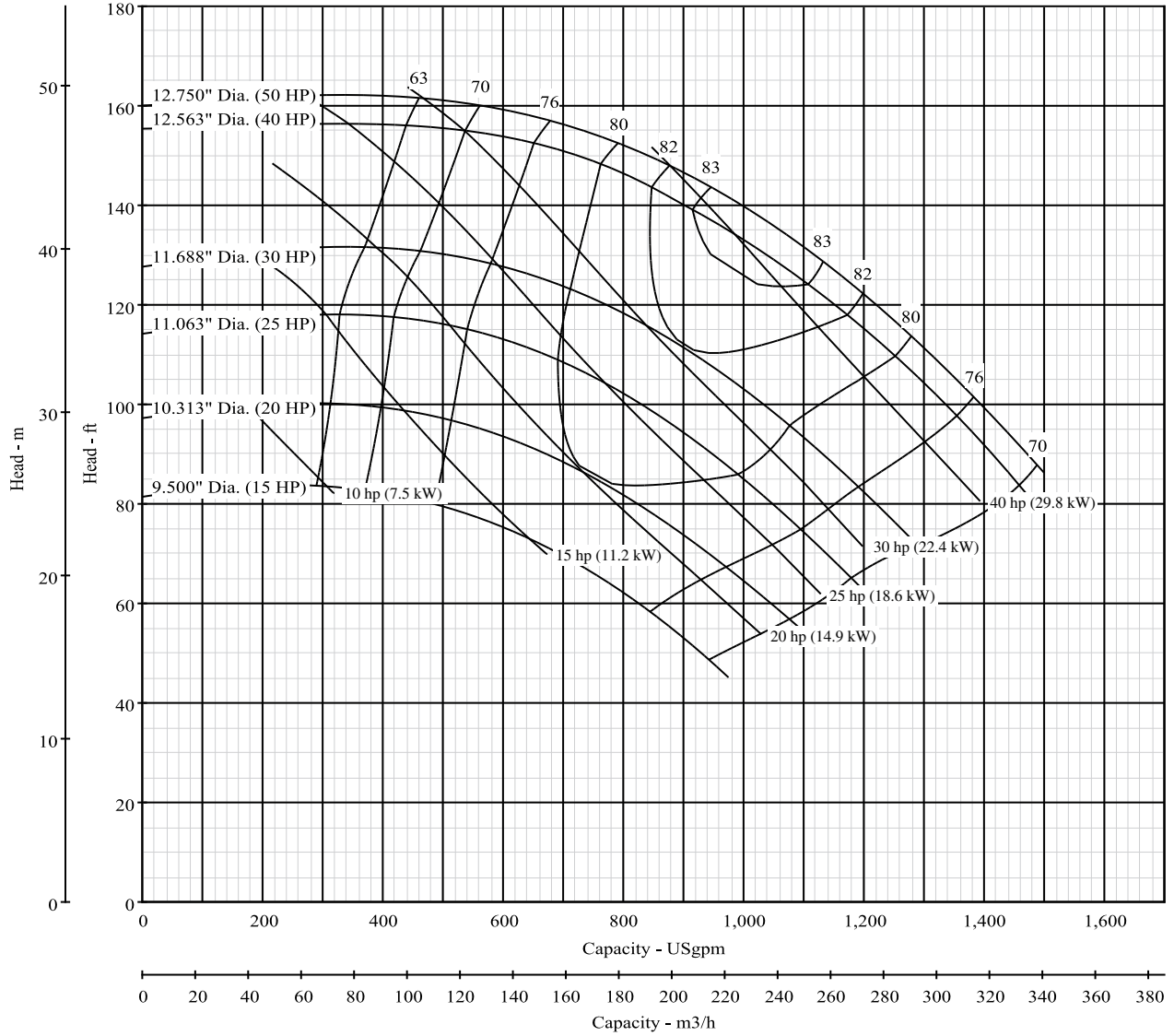

Pump Size: 4 x 5 x 12 BH

Model: B4G_BH

Curve No. 1234

Type	CCMD	FM CPLG	FM BELT	SAE	Hydraulic	AC Engine
Model	B4GPBH	B4GRMBH	B4GRMBH	B4GQBH		
RPM	1201-1800	1400-2400	1400-2200	1600-2400		

Dia. 12.75"

Nominal RPM: **VARIOUS**
 Based on Fresh Water @ 68°F (20°C)
 Maximum Working Pressure: 266 PSI (18 BAR)

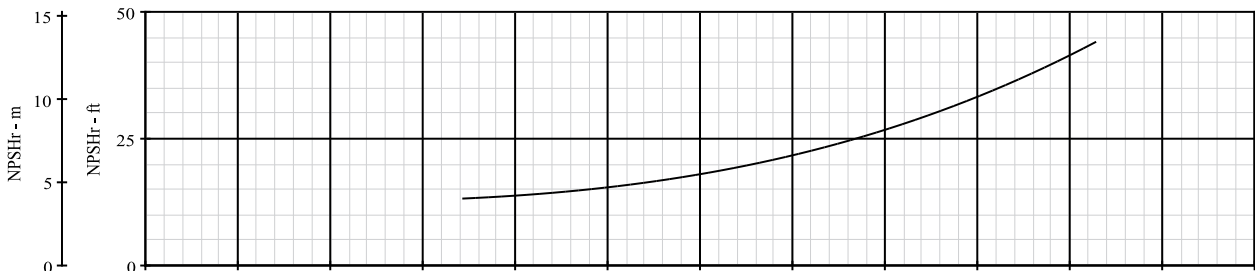
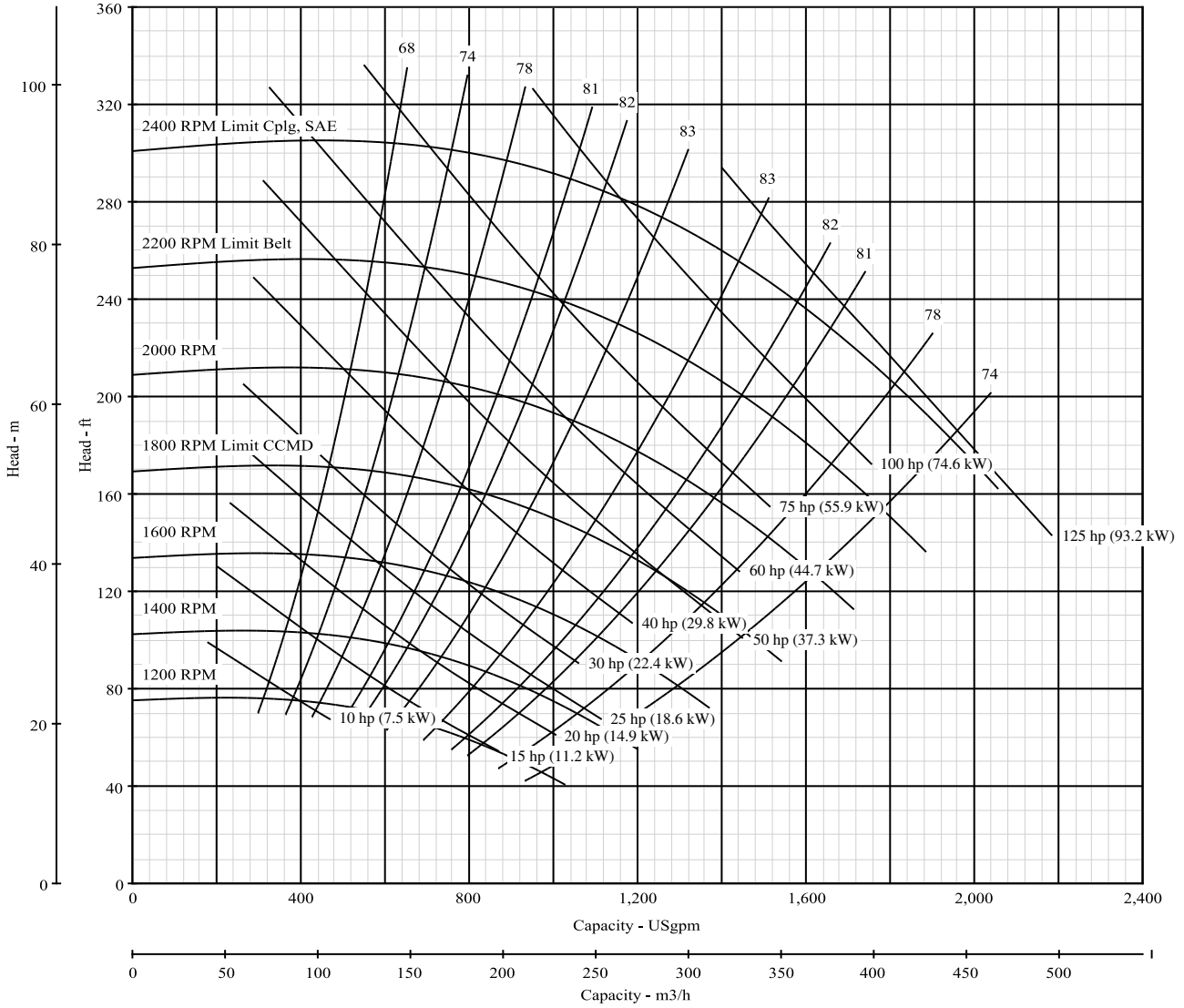

*NPSH data shown is at maximum speed

Pump Size: 8 x 10 x 12 BM

Model: B8G_BM

Curve No. 5028A

Type	CCMD	FM CPLG	FM BELT	SAE	Hydraulic	AC Engine
Model	B8GPBM	B8GRMBM		B8GQBM		

Nominal RPM: **1770**
 Based on Fresh Water @ **68°F (20°C)**
 Maximum Working Pressure: 266 PSI (18 BAR)

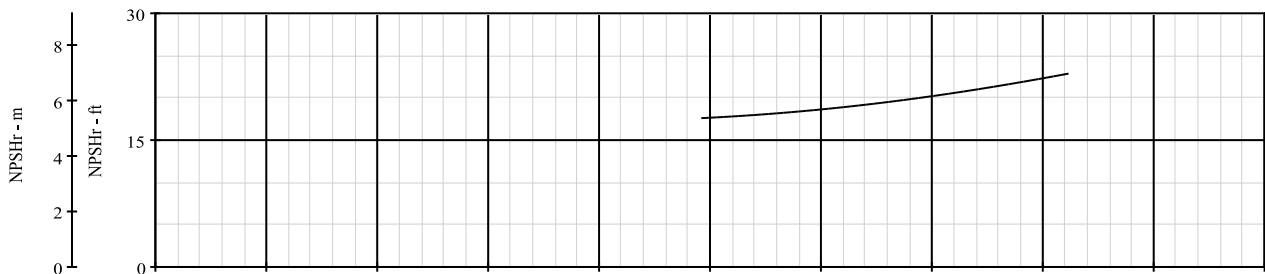
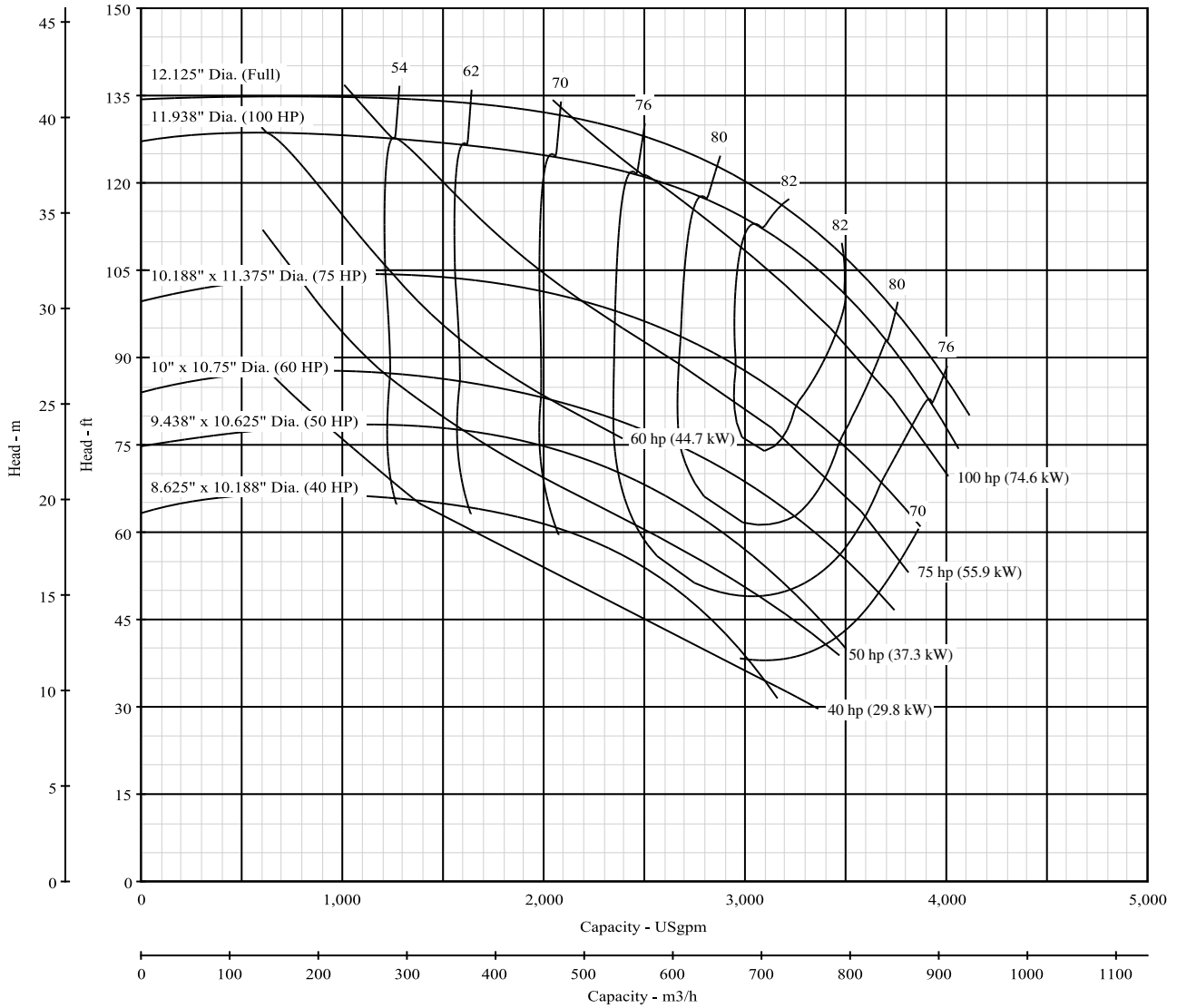

Pump Size: 8 x 10 x 12 BM

Model: B8G_BM

Curve No. 5033

Type	CCMD	FM CPLG	FM BELT	SAE	Hydraulic	AC Engine
Model	B8GPBM	B8GRMBM	B8GRMBM			

Nominal RPM: **1165**
 Based on Fresh Water @ **68°F (20°C)**
 Maximum Working Pressure: **266 PSI (18 BAR)**

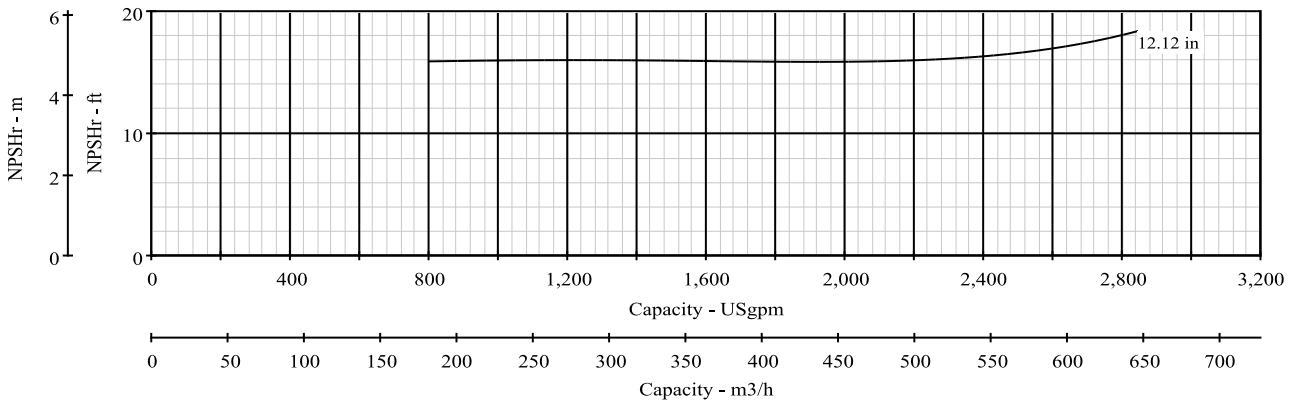
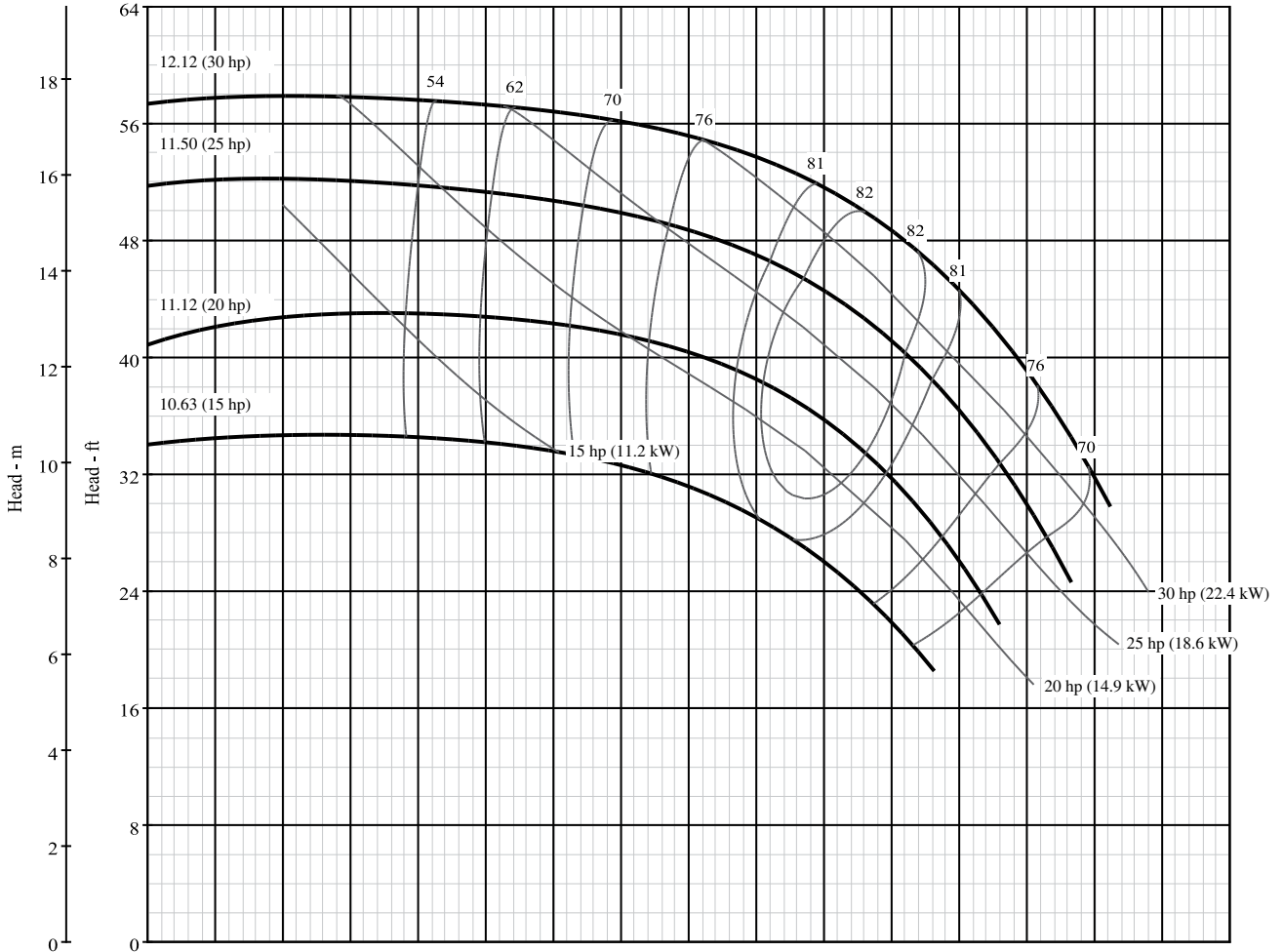

Pump Size: 8 x 10 x 12 BM

Model: B8G_BM

Curve No. 5028A

Type	CCMD	FM CPLG	FM BELT	SAE	Hydraulic	AC Engine
Model	B8GPBM	B8GRMBM	B8GRMBM	B8GQBM		
RPM	901-1800	1200-2200	1200-1700	1000-2100		

Dia. 12.13"

Nominal RPM: **VARIOUS**
 Based on Fresh Water @ 68°F (20°C)
 Maximum Working Pressure: 266 PSI (18 BAR)

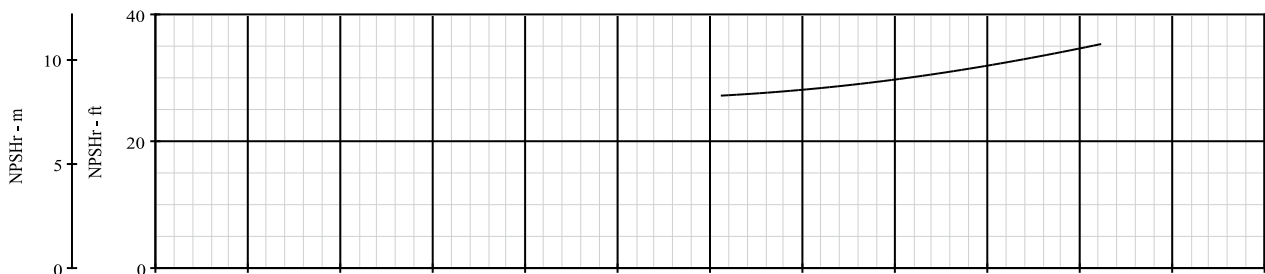
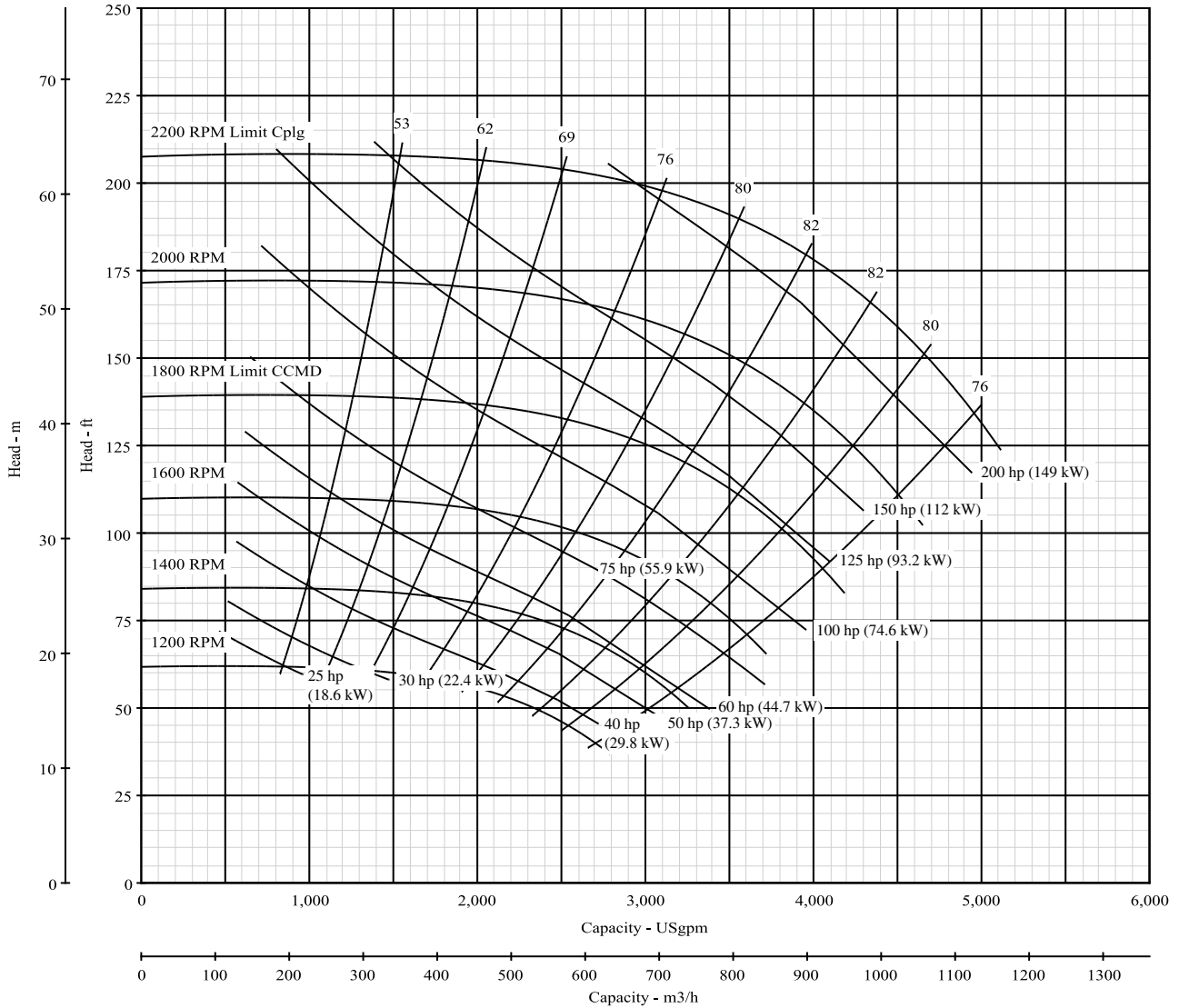

*NPSH data shown is at maximum speed

Pump Size: 10 x 12 x 12 BM

Model: B10G_BM - 4 pole

Curve No. 7632

Type	CCMD	FM CPLG	FM BELT	SAE	Hydraulic	AC Engine
Model	B10GPBM	B10GRMBM		B10GQBM		

Nominal RPM: **1770**
 Based on Fresh Water @ **68°F (20°C)**
 Maximum Working Pressure: **266 PSI (18 BAR)**

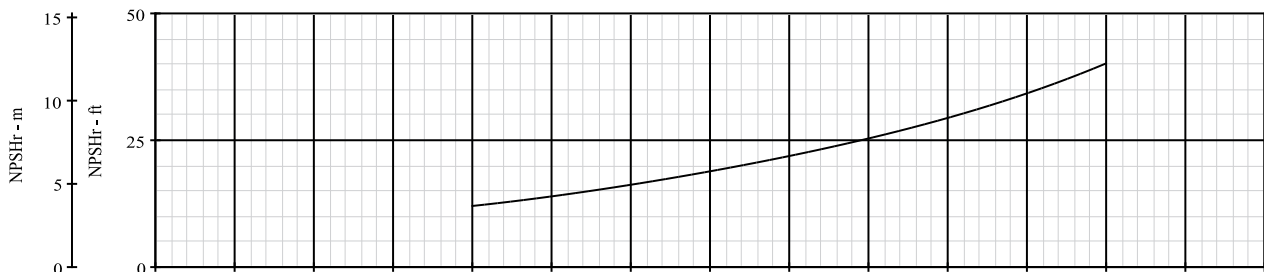
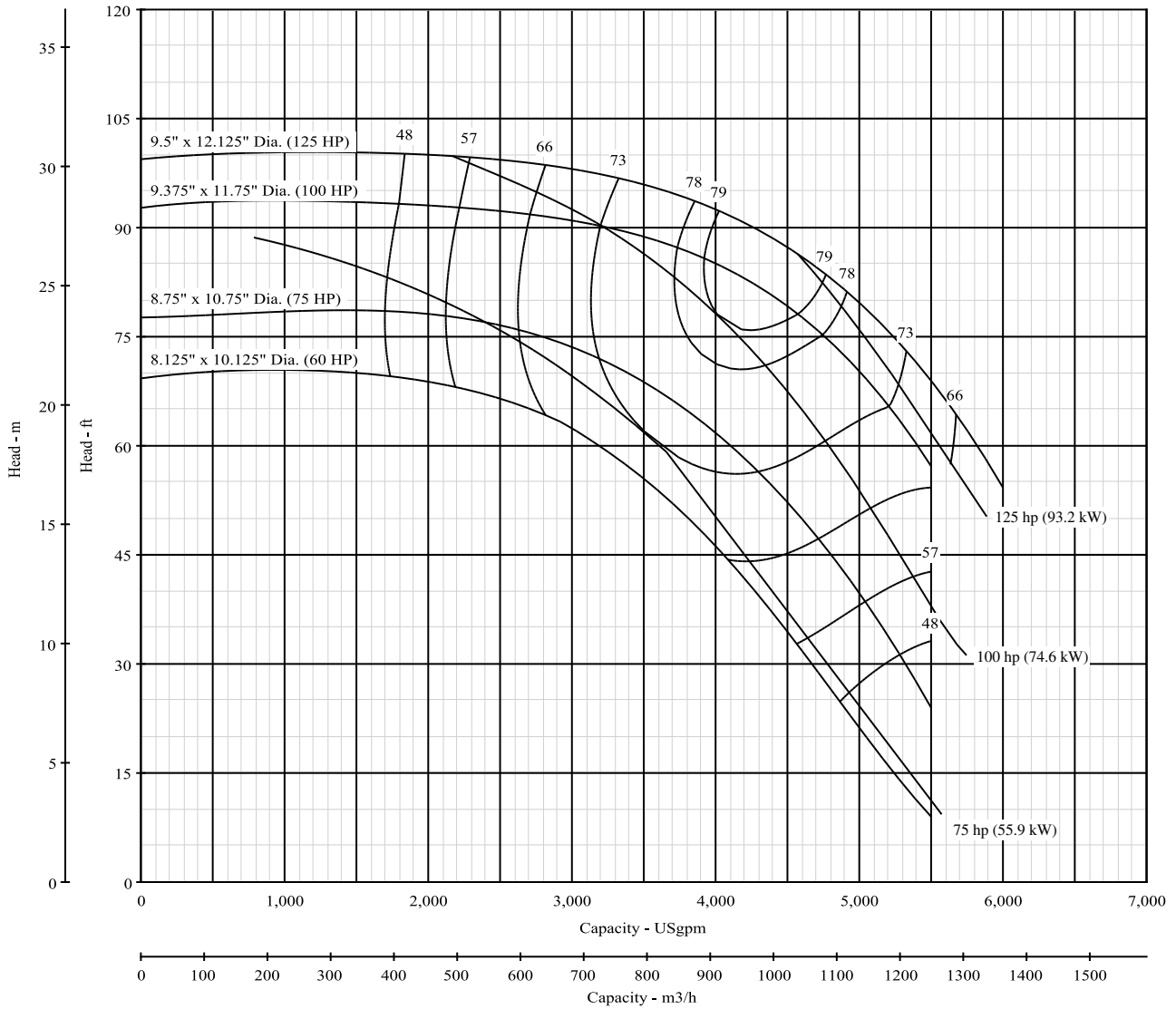

Pump Size: 10 X 12 X 12 BM

Model: B10G_BM - 6 pole

Curve No. 7512

Type	CCMD	FM CPLG	FM BELT	SAE	Hydraulic	AC Engine
Model	B10GPBM	B10GRMBM	B10GRMBM	B10GQBM		

Nominal RPM: **1160**
 Based on Fresh Water @ **68°F (20°C)**
 Maximum Working Pressure: **266 PSI (18 BAR)**

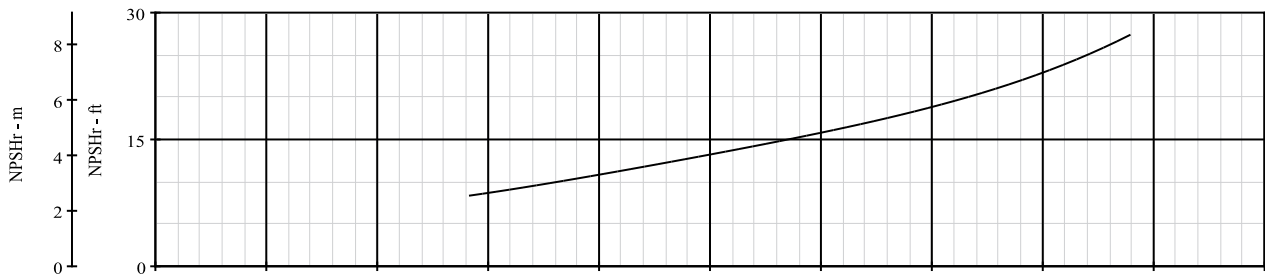
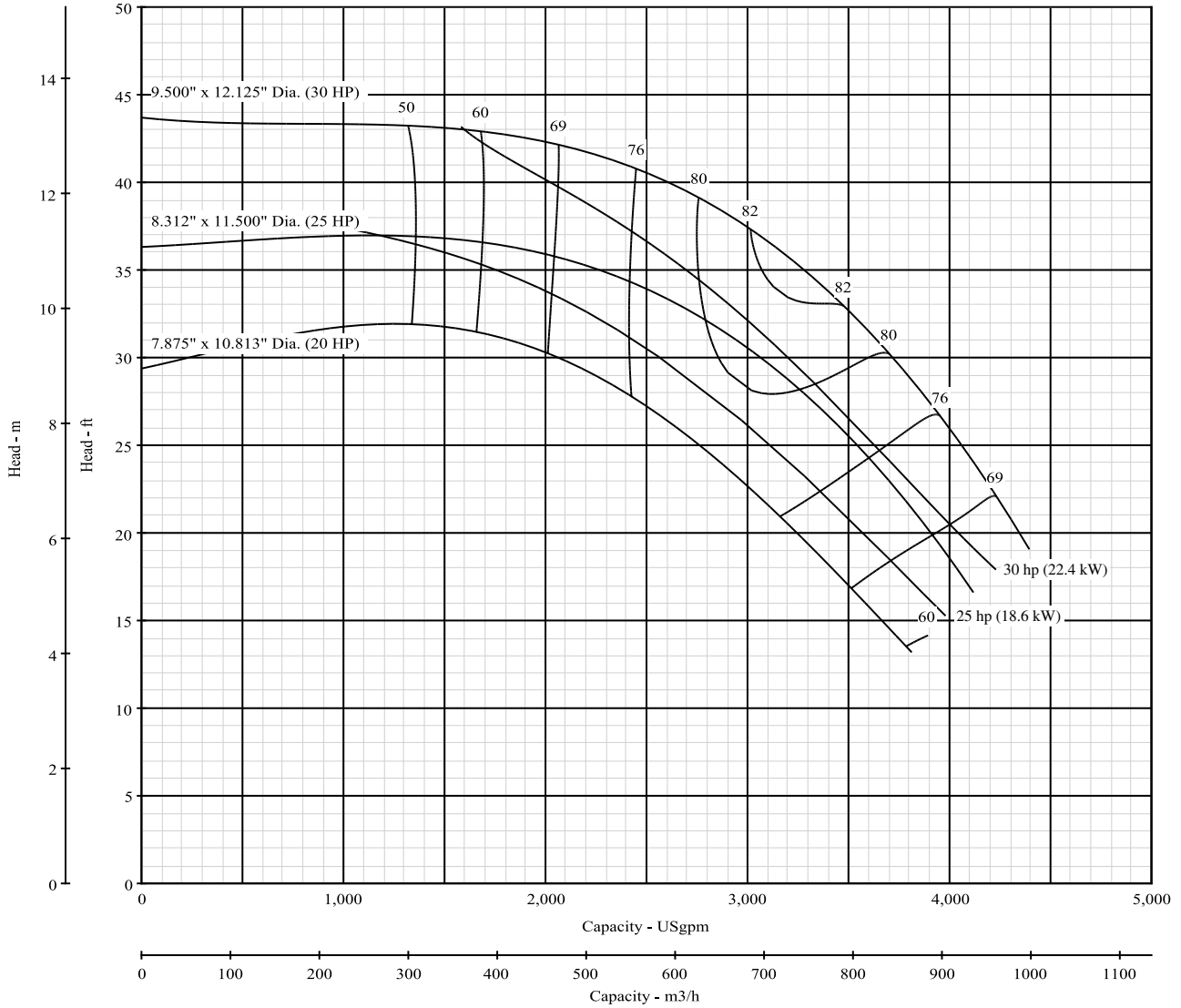

Pump Size: 10 x 12 x 12 BM

Model: B10G_BM

Curve No. 7512

Type	CCMD	FM CPLG	FM BELT	SAE	Hydraulic	AC Engine
Model	B10GPBM	B10GRMBM	B10GRMBM	B10GQBM		
RPM	901-1200	1000-1800	1000-1700	900-1900		

Dia. 12.13"

Nominal RPM: **VARIOUS**
 Based on Fresh Water @ 68°F (20°C)
 Maximum Working Pressure: 266 PSI (18 BAR)

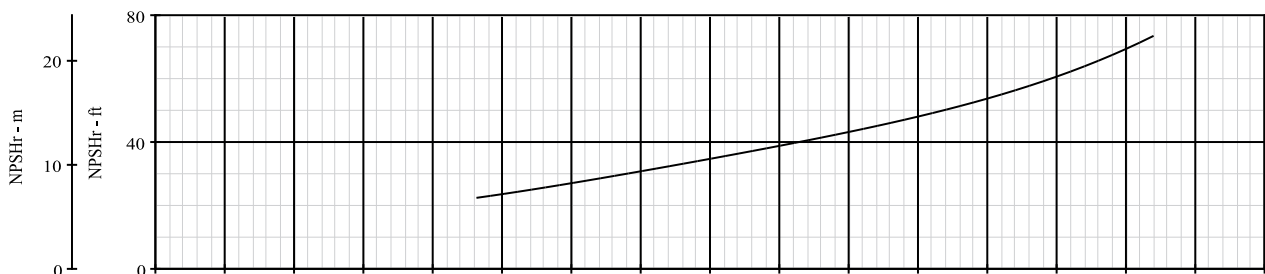
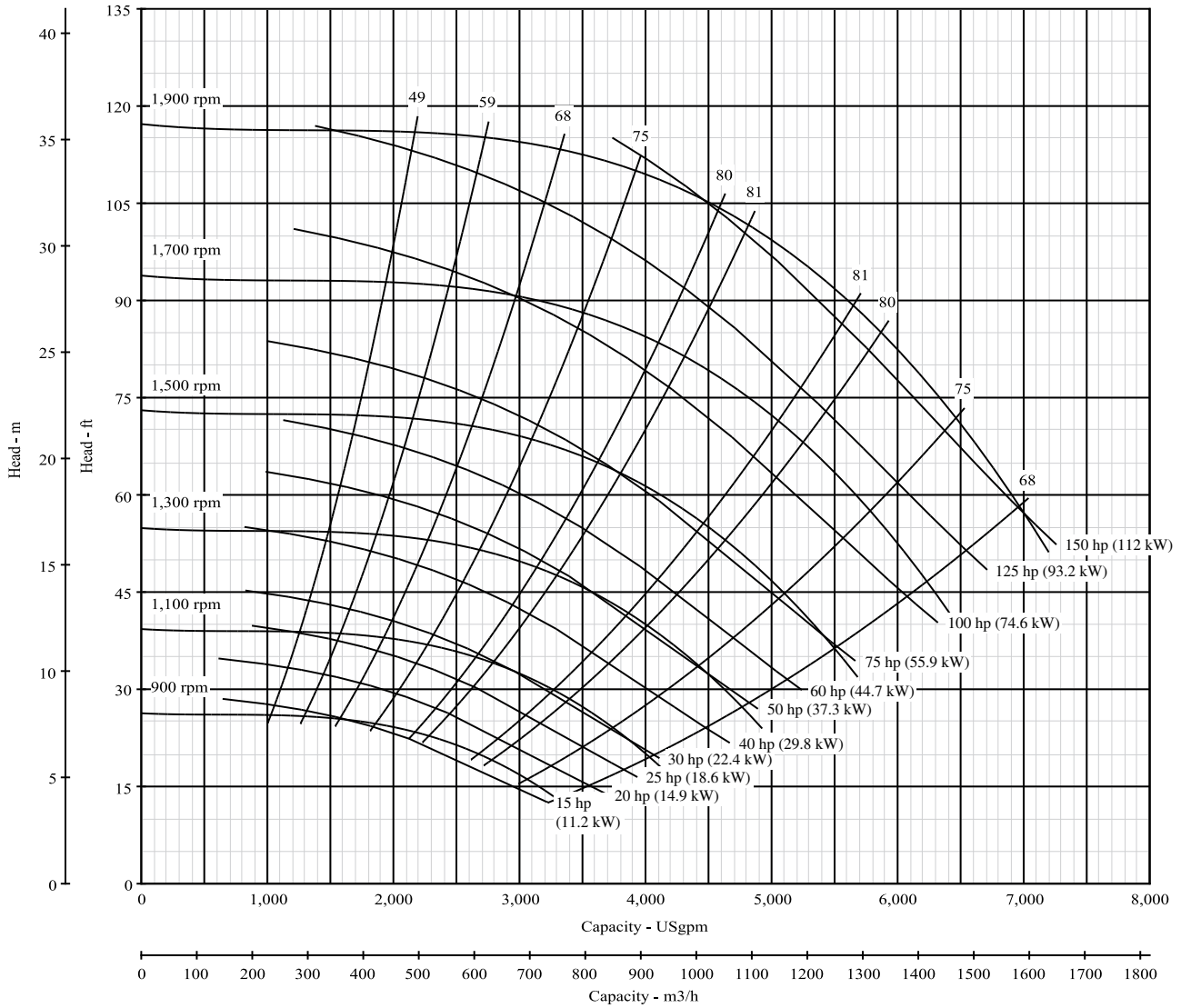

*NPSH data shown is at maximum speed

Pump Size: 2-1/2 x 4 x 13 BL

Model: B2-1/2J_BL

Curve No. 7045

Type	CCMD	FM CPLG	FM BELT	SAE	Hydraulic	AC Engine
Model				B2-1/2JQBL		
RPM				1600-2800		

Dia. 13.50"

Nominal RPM: **VARIOUS**
 Based on Fresh Water @ 68°F (20°C)
 Maximum Working Pressure: 266 PSI (18 BAR)

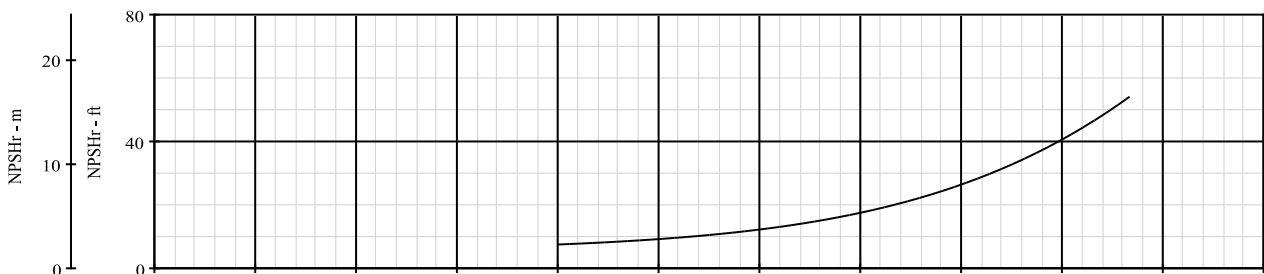
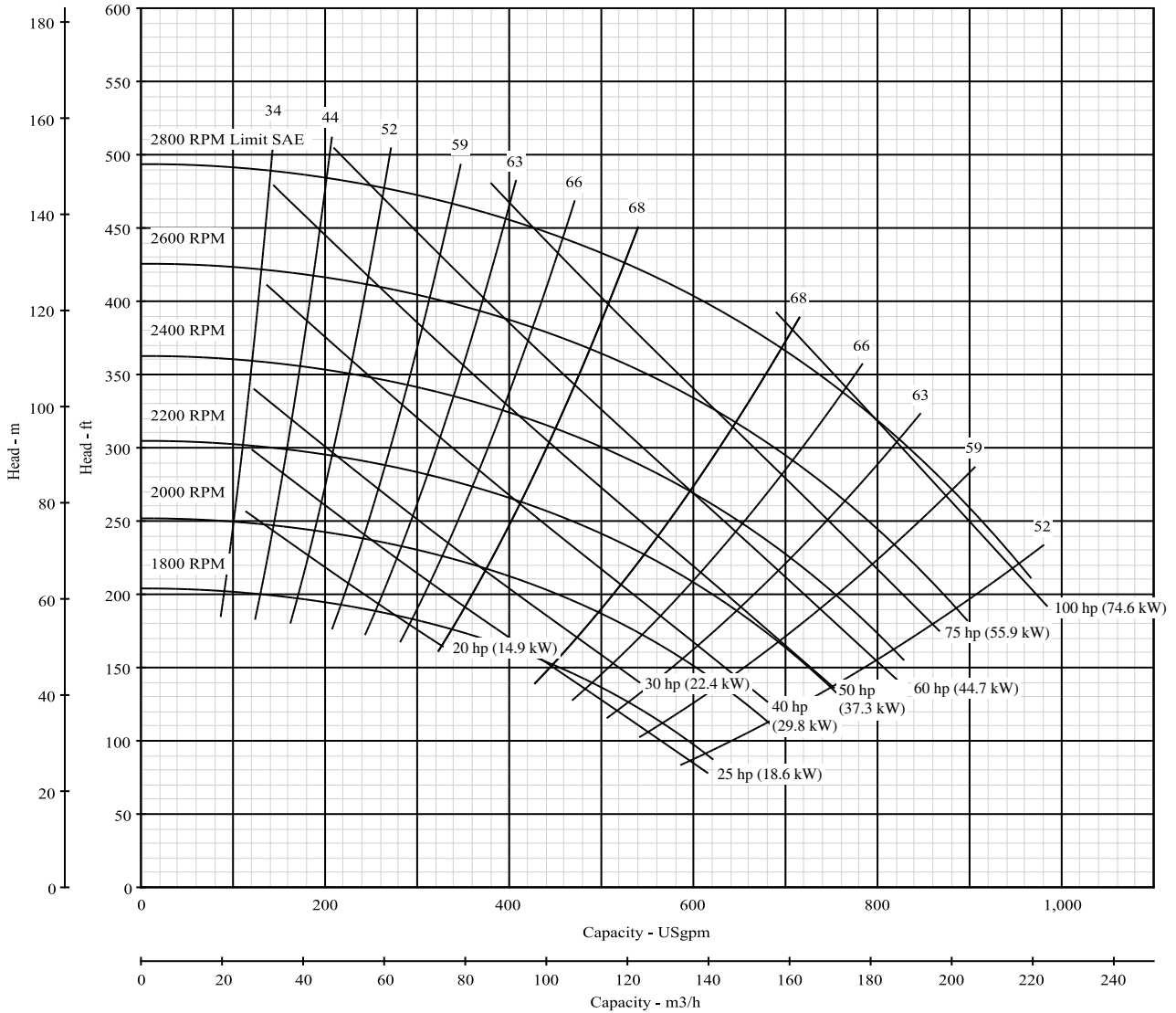

*NPSH data shown is at maximum speed

Pump Size: 2-1/2 x 4 x 13 BM

Model: B2-1/2J_BM

Curve No. 6266

Type	CCMD	FM CPLG	FM BELT	SAE	Hydraulic	AC Engine
Model	B2-1/2JPBM	B2-1/2JRMBM	B2-1/2JRMBM	B2-1/2JQBM		

Nominal RPM: **1750**
 Based on Fresh Water @ **68°F (20°C)**
 Maximum Working Pressure: 266 PSI (18 BAR)

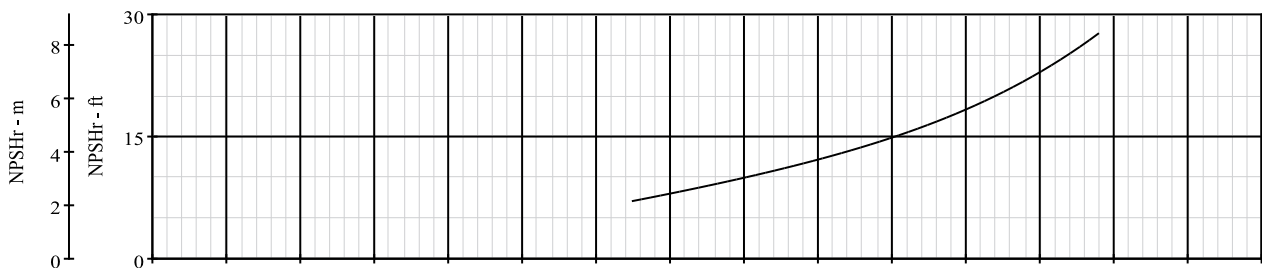
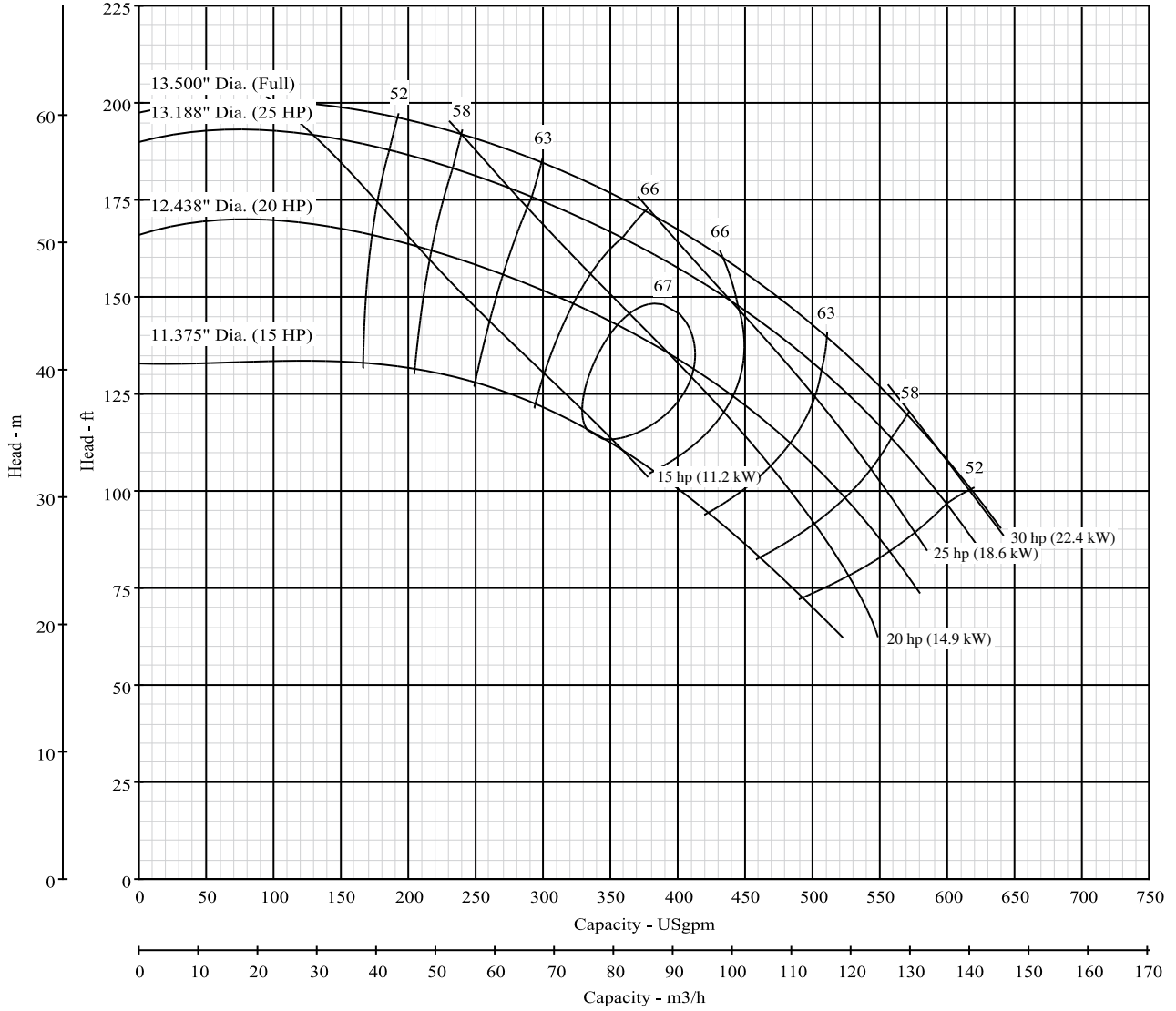

Pump Size: 2-1/2 x 4 x 13 BM

Model: B2-1/2J_BM

Curve No. 6266

Type	CCMD	FM CPLG	FM BELT	SAE	Hydraulic	AC Engine
Model	B2-1/2JPBM	B2-1/2JRMBM	B2-1/2JRMBM	B2-1/2JQBM	B2-1/2JRMBM	
RPM	1201-1800	1400-2700	1400-2700	1600-2800	1400-2800	

Dia. 13.50"

Nominal RPM: **VARIOUS**
 Based on Fresh Water @ 68°F (20°C)
 Maximum Working Pressure: 266 PSI (18 BAR)

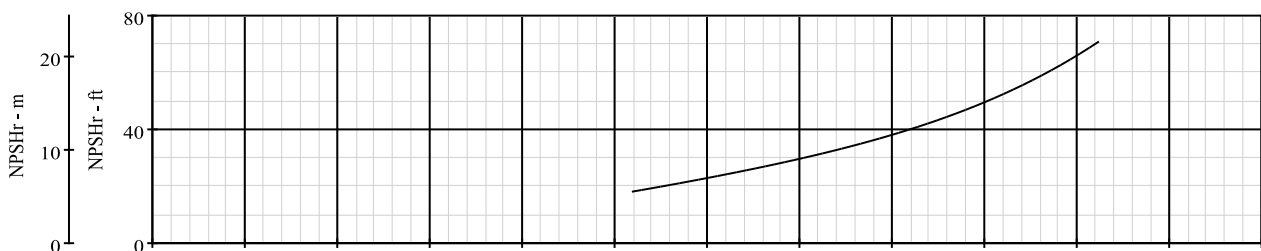
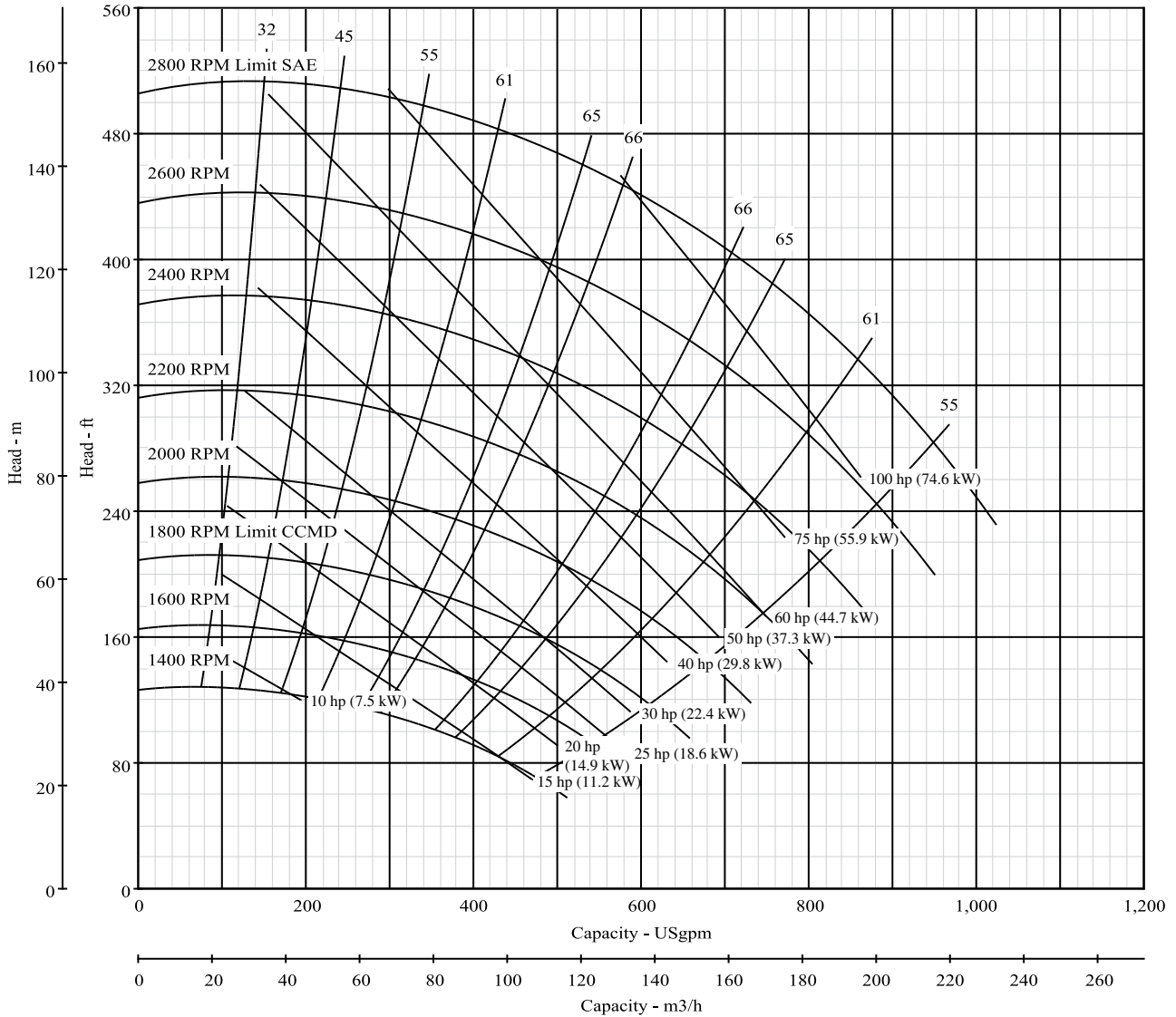

*NPSH data shown is at maximum speed

Pump Size: 3 x 4 x 13 BL

Model: B3J_BL

Curve No. 5845

Type	CCMD	FM CPLG	FM BELT	SAE	Hydraulic	AC Engine
Model	B3JPBL					

Nominal RPM: **1750**
 Based on Fresh Water @ **68°F (20°C)**
 Maximum Working Pressure: **266 PSI (18 BAR)**

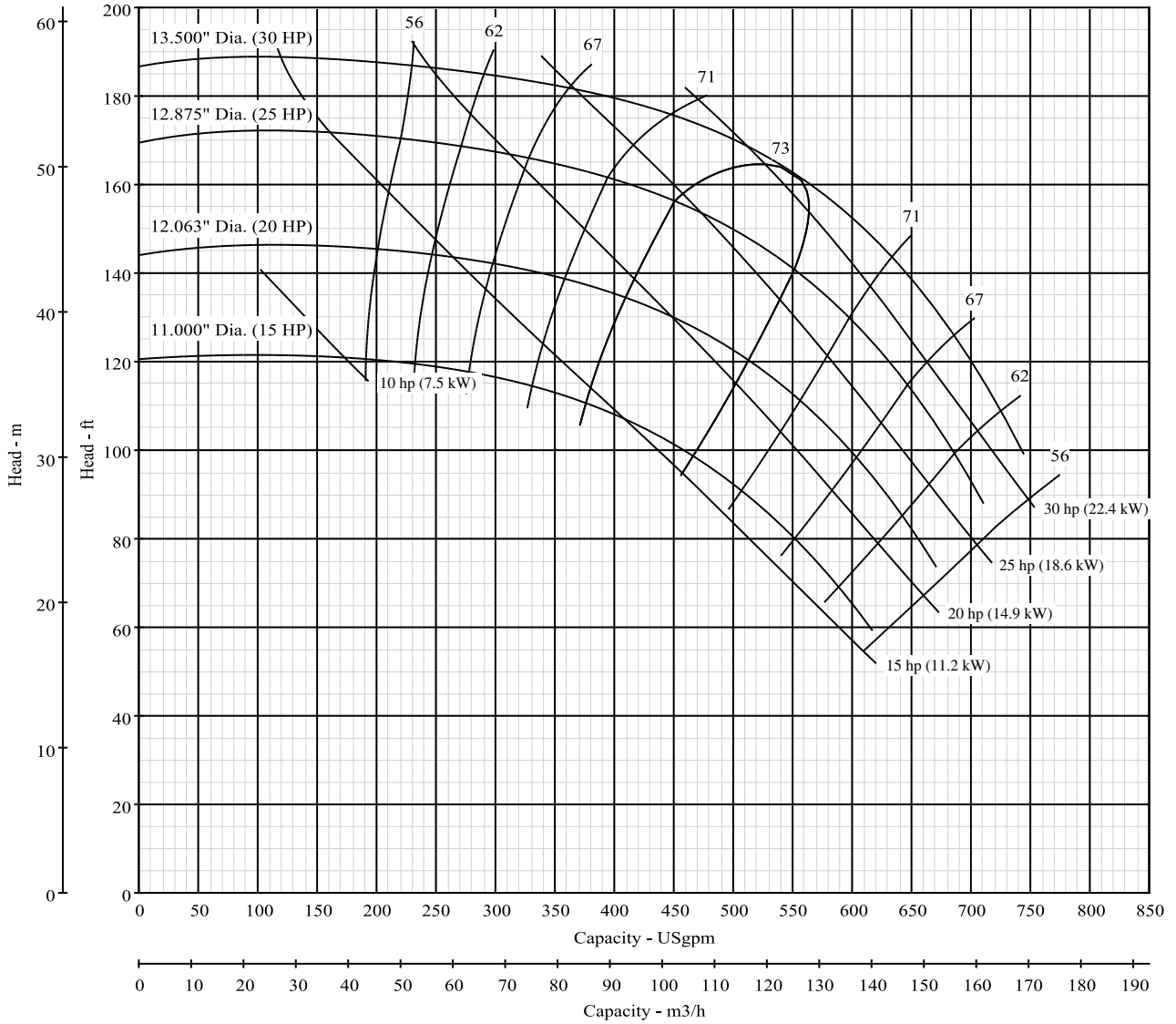

Pump Size: 3 x 4 x 13 BL

Model: B3J_BL

Curve No. 5845

Type	CCMD	FM CPLG	FM BELT	SAE	Hydraulic	AC Engine
Model	B3JPBL					
RPM	1201-1800					

Dia. 13.50"

Nominal RPM: **VARIOUS**
 Based on Fresh Water @ 68°F (20°C)
 Maximum Working Pressure: 266 PSI (18 BAR)

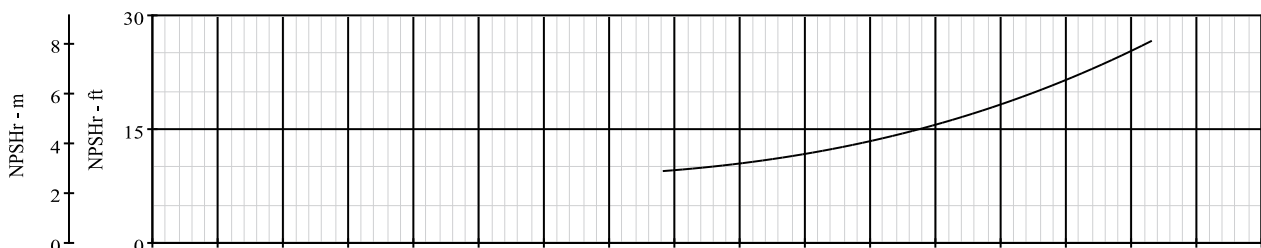
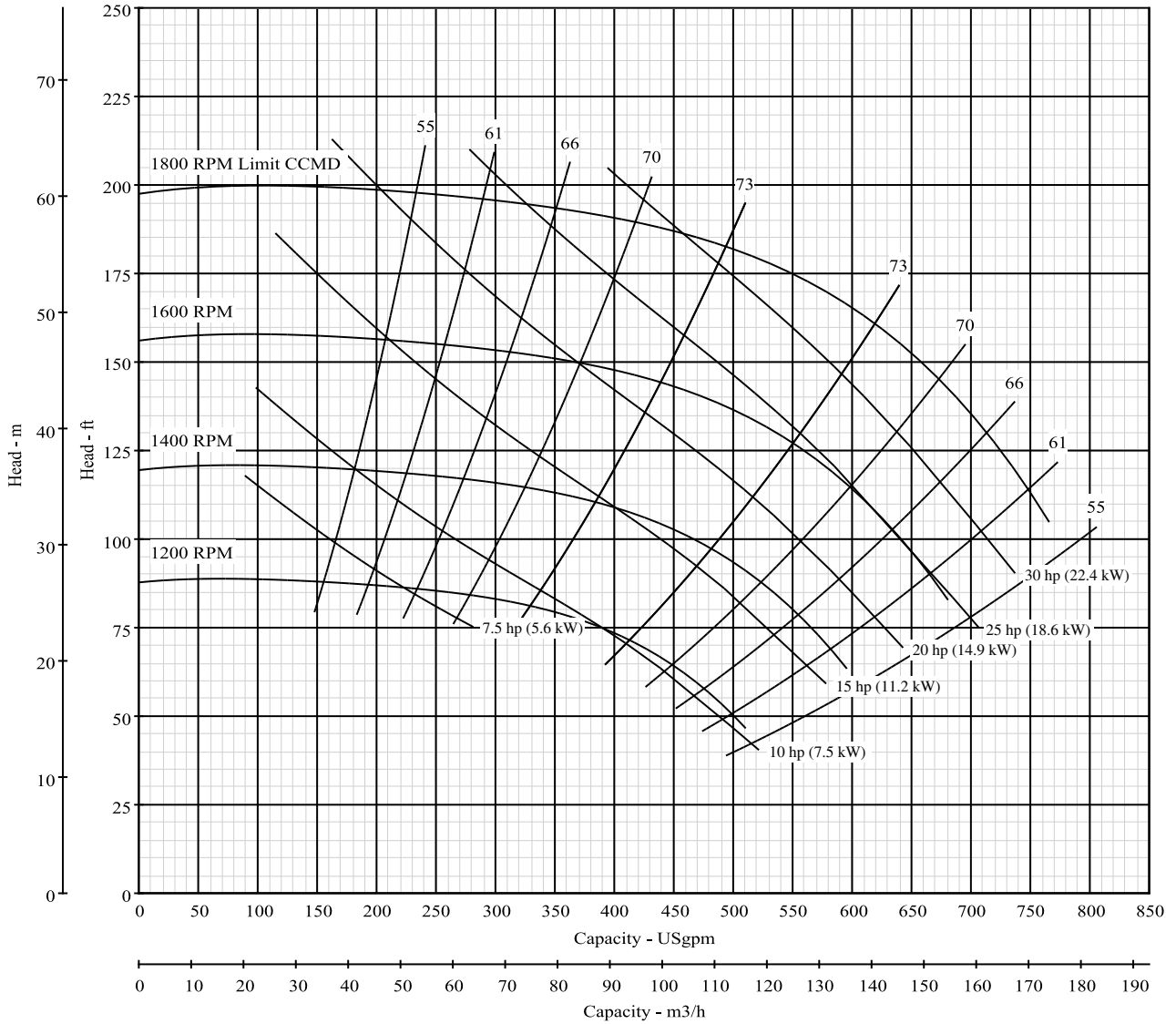

*NPSH data shown is at maximum speed

Pump Size: 3 x 4 x 13 BM

Model: B3J_BM

Curve No. 5846

Type	CCMD	FM CPLG	FM BELT	SAE	Hydraulic	AC Engine
Model	B3JPBM	B3JRMBM	B3JRMBM	B3JQBM		

Nominal RPM: **1750**
 Based on Fresh Water @ **68°F (20°C)**
 Maximum Working Pressure: **266 PSI (18 BAR)**

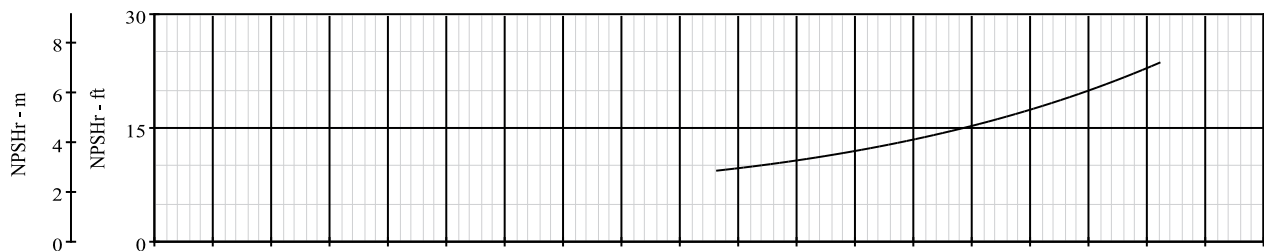
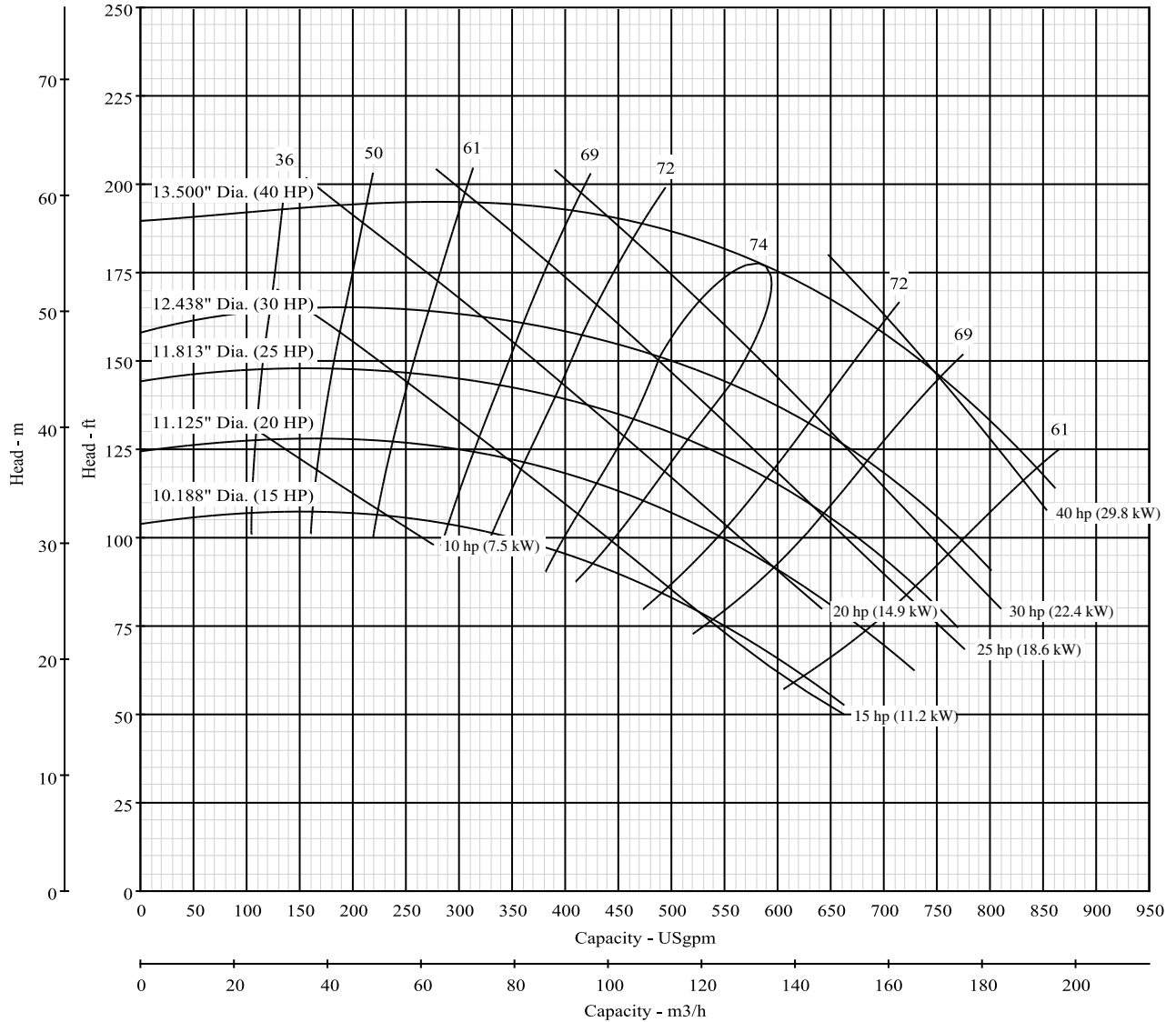

Pump Size: 3 x 4 x 13 BM

Model: B3J_BM

Curve No. 5846

Type	CCMD	FM CPLG	FM BELT	SAE	Hydraulic	AC Engine
Model	B3JPBM	B3JRMBM	B3JRMBM	B3JQBM	B3JRMBM	
RPM	1201-1800	1400-2700	1400-2700	1600-3000	1400-2700	

Dia. 13.50"

Nominal RPM: **VARIOUS**
 Based on Fresh Water @ 68°F (20°C)
 Maximum Working Pressure: 266 PSI (18 BAR)

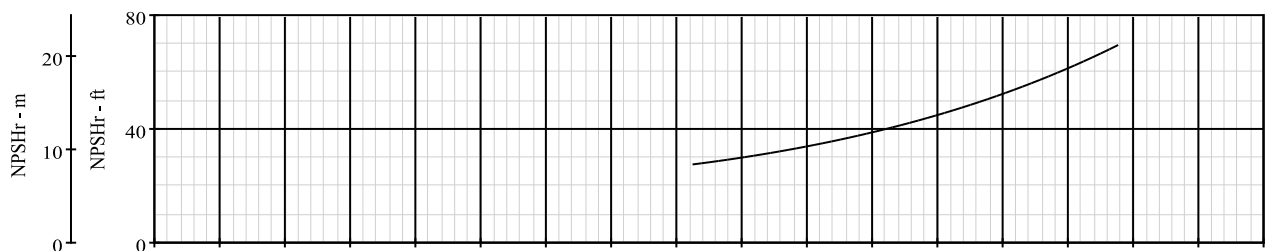
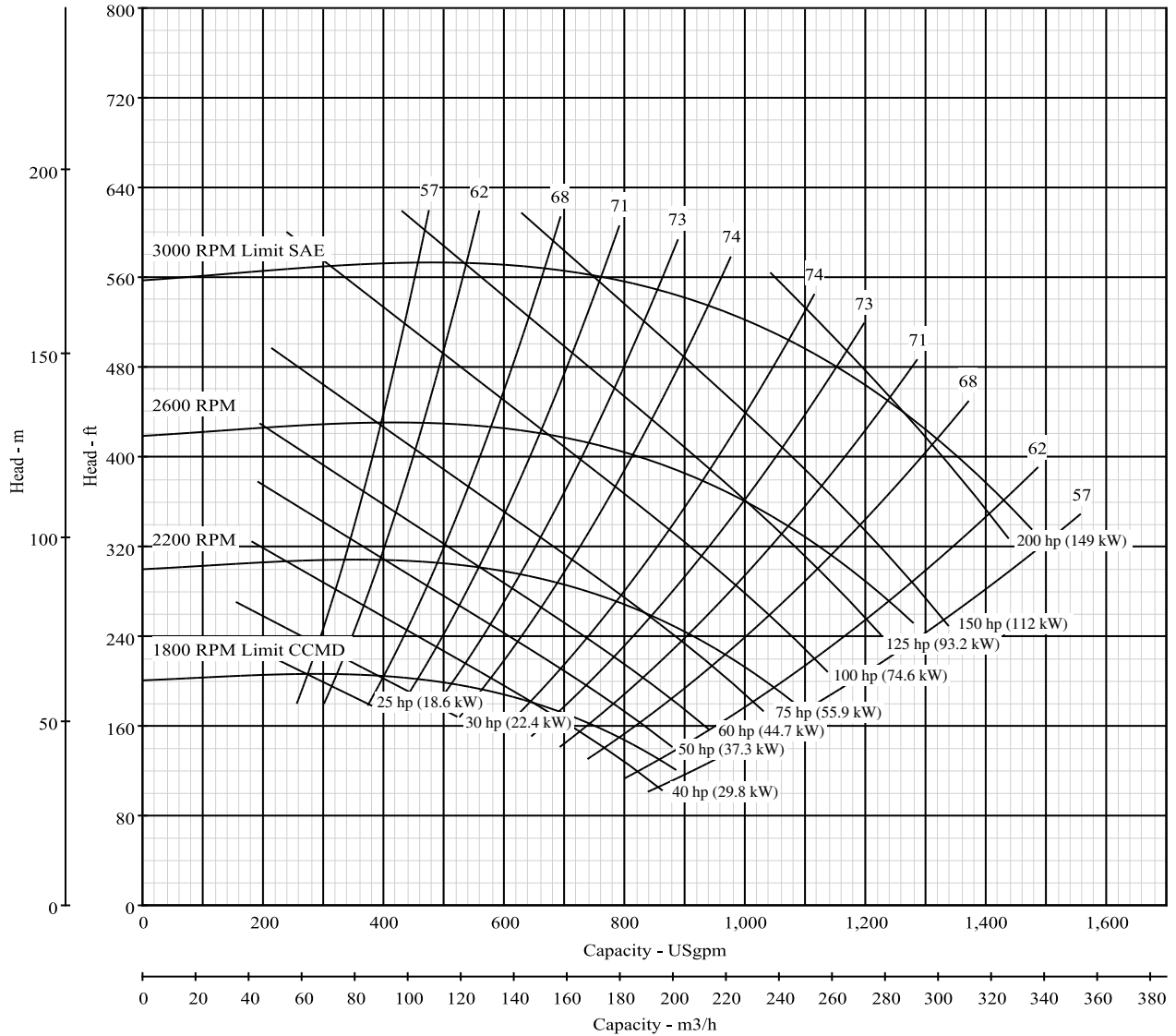

*NPSH data shown is at maximum speed

Pump Size: 4 x 5 x 13 BH

Model: B4J_BH

Curve No. 9013

Type	CCMD	FM CPLG	FM BELT	SAE	Hydraulic	AC Engine
Model	B4JPBH	B4JRMBH	B4JRMBH	B4JQBH		

Nominal RPM: **1750**
 Based on Fresh Water @ **68°F (20°C)**
 Maximum Working Pressure: **266 PSI (18 BAR)**

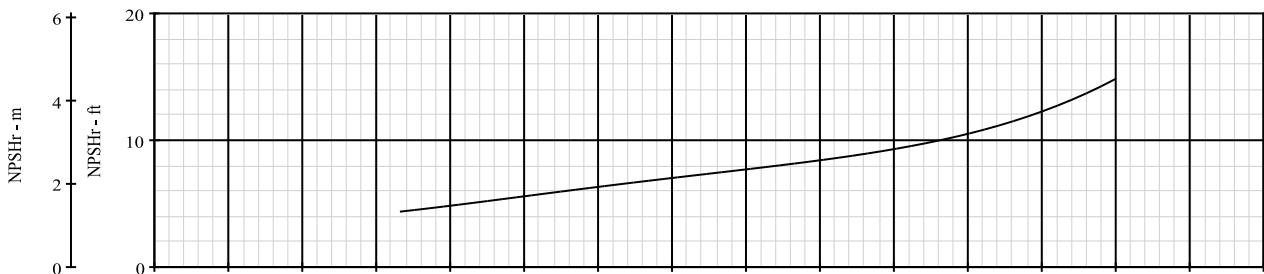
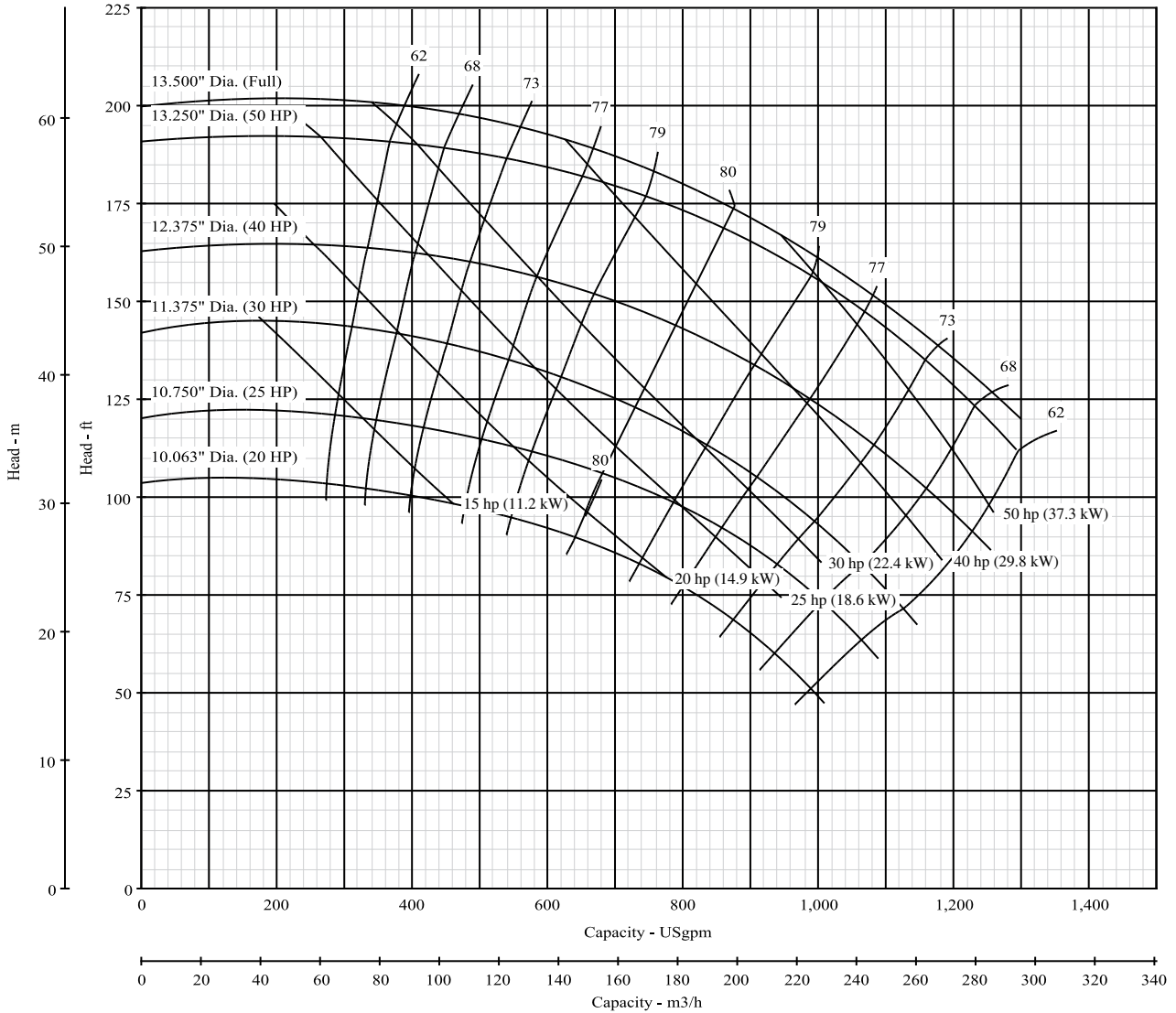

Pump Size: 4 x 5 x 13 BH

Model: B4J_BH

Curve No. 9013

Type	CCMD	FM CPLG	FM BELT	SAE	Hydraulic	AC Engine
Model	B4JPBH	B4JRMBH	B4JRMBH	B4JQBH	B4JRMBH	
RPM	1201-1800	1400-2400	1400-2200	1400-2400	1400-2400	

Dia. 13.50"

Nominal RPM: **VARIOUS**
 Based on Fresh Water @ 68°F (20°C)
 Maximum Working Pressure: 266 PSI (18 BAR)

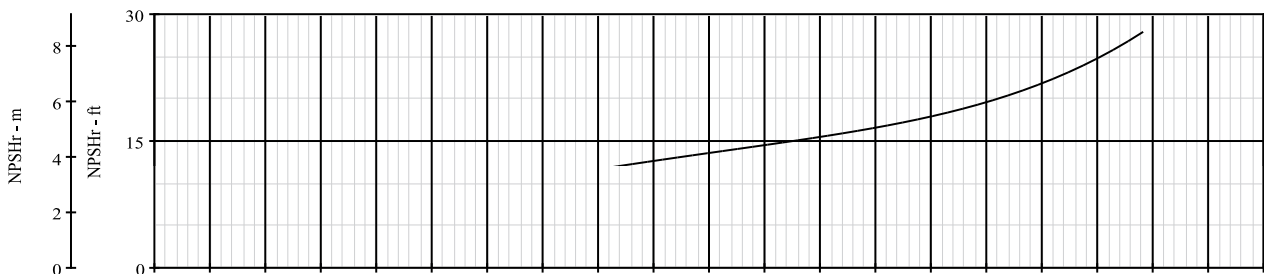
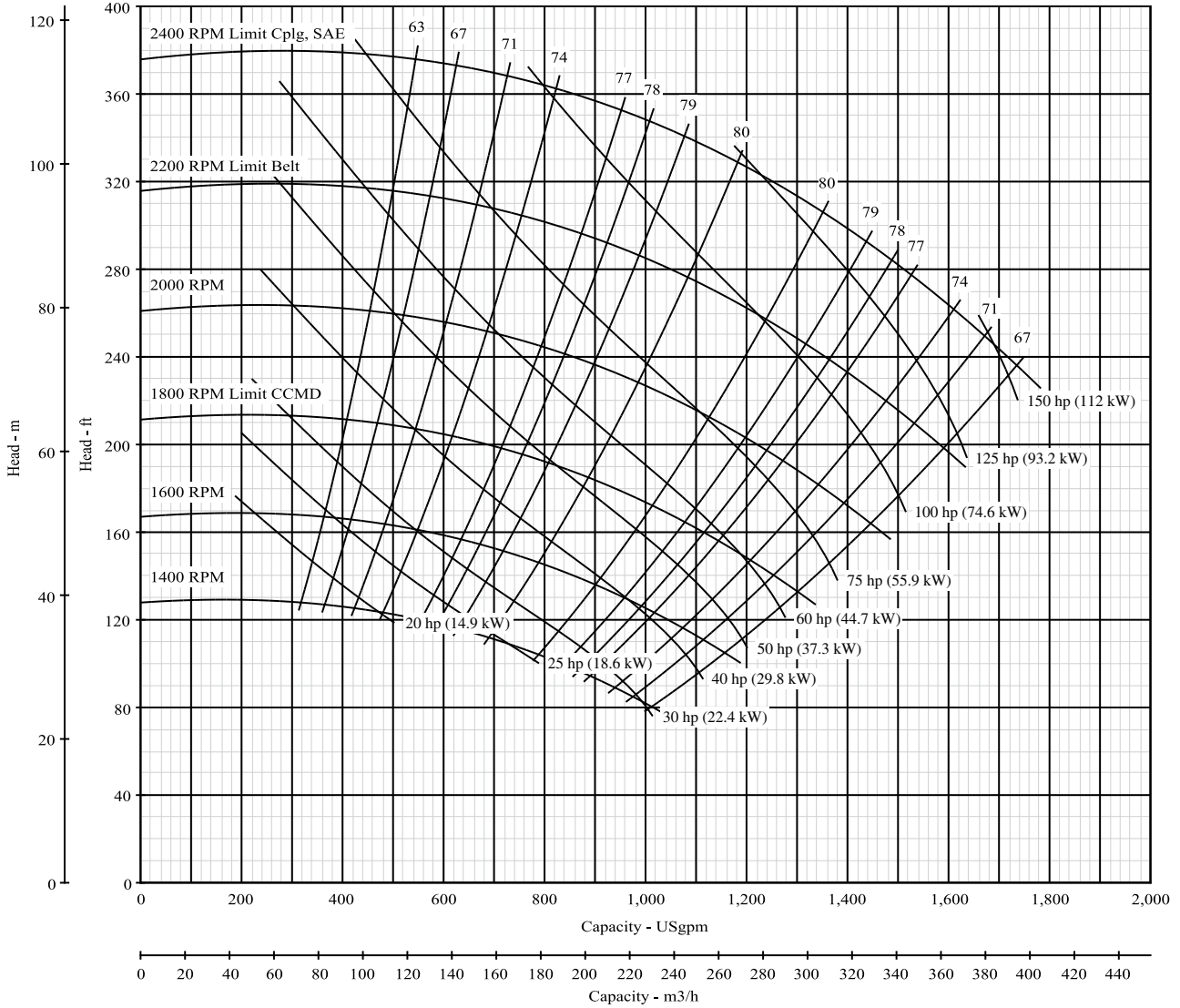

*NPSH data shown is at maximum speed

Pump Size: 4 x 6 x 13 BHH

Model: B4J_BHH

Curve No. 9017

Type	CCMD	FM CPLG	FM BELT	SAE	Hydraulic	AC Engine
Model	B4JPBHH	B4JRMBHH	B4JRMBHH			

Nominal RPM: **1750**
 Based on Fresh Water @ **68°F (20°C)**
 Maximum Working Pressure: **266 PSI (18 BAR)**

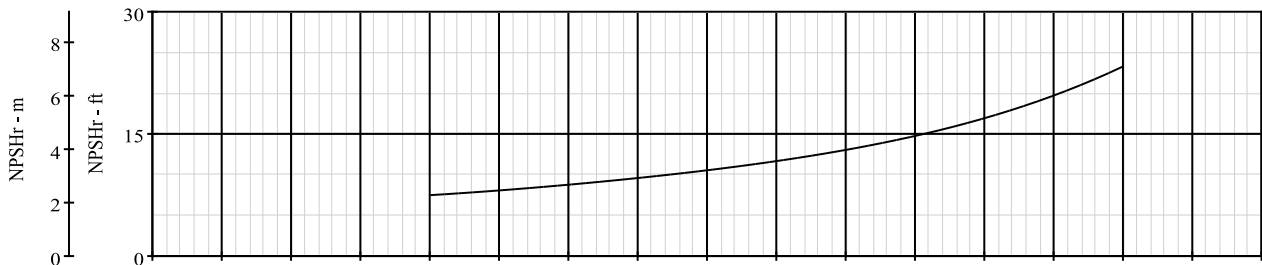
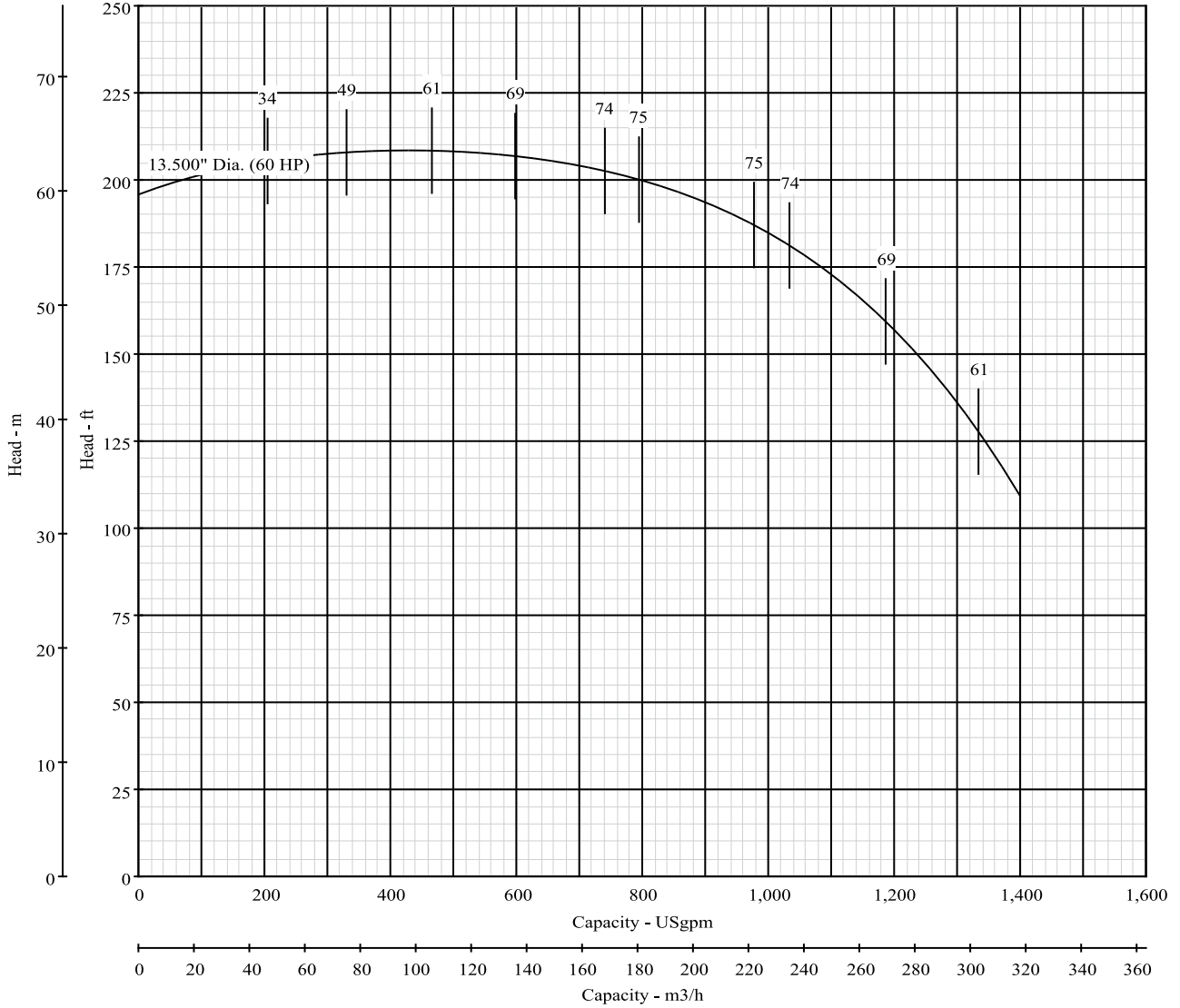

Pump Size: 4 x 6 x 13 BHH

Model: B4J_BHH

Curve No. 9017

Type	CCMD	FM CPLG	FM BELT	SAE	Hydraulic	AC Engine
Model	B4JPBHH	B4JRMBHH	B4JRMBHH			
RPM	1201-1800	1400-2400	1400-2200			

Full Dia. 13.50" Nominal RPM: **VARIOUS**
Based on Fresh Water @ 68°F (20°C)
Maximum Working Pressure: 266 PSI (18 BAR)

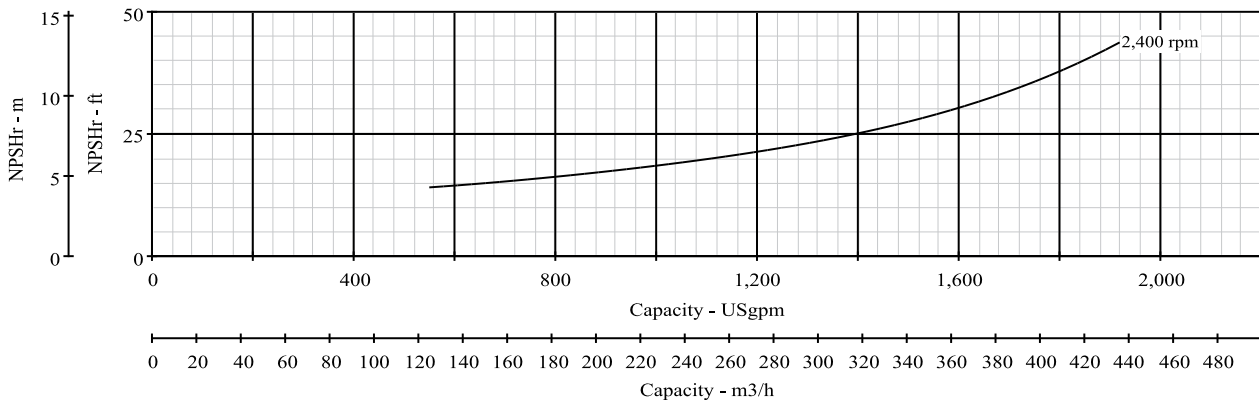
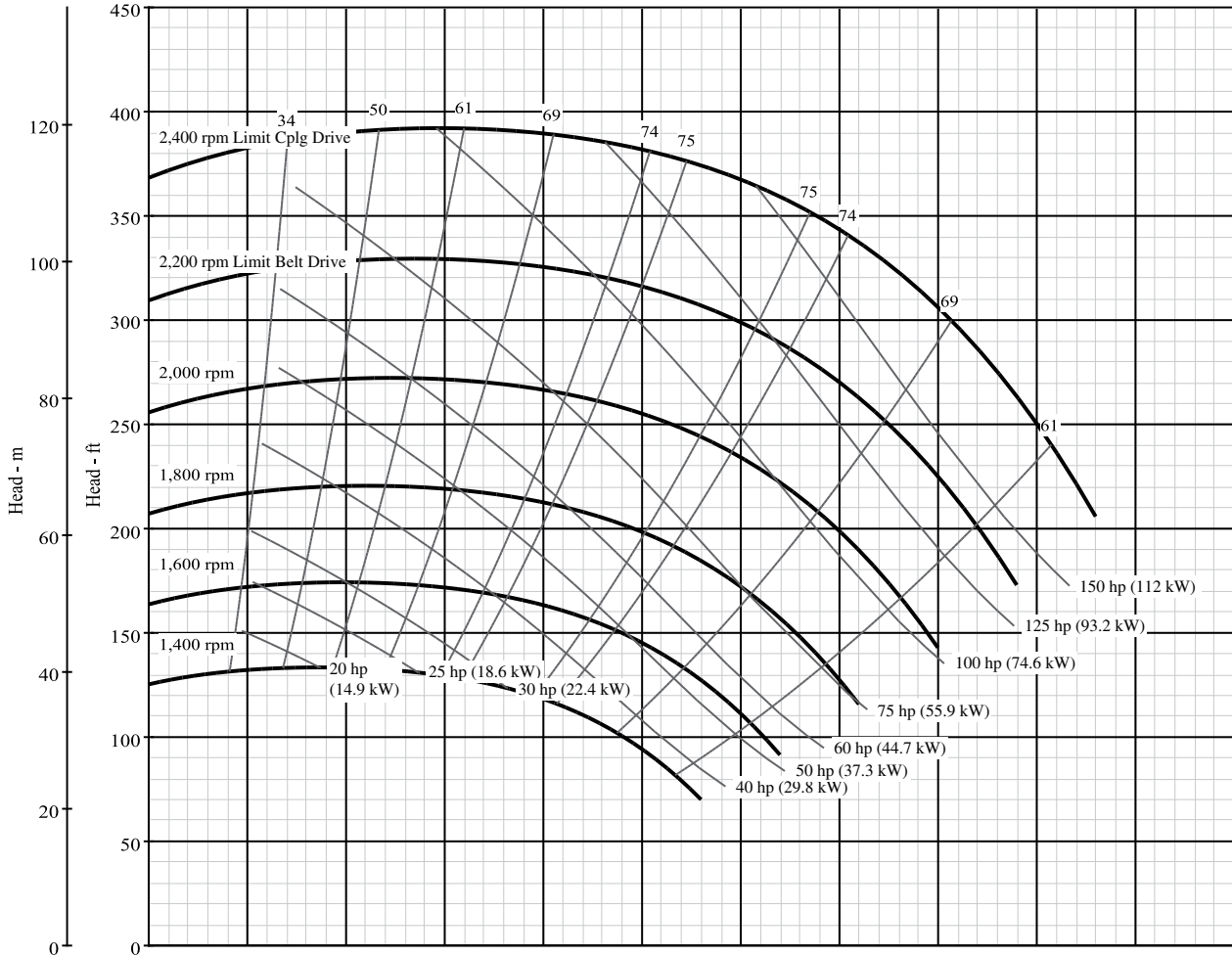

*NPSH data shown is at maximum speed

Pump Size: 6 x 8 x 13 BL

Model: B6J_BL

Curve No. 5026

Type	CCMD	FM CPLG	FM BELT	SAE	Hydraulic	AC Engine
Model	B6JPBL	B6JRMBL	B6JRMBL	B6JQBL		

Nominal RPM: **1750**
 Based on Fresh Water @ **68 °F (20 °C)**
 Maximum Working Pressure: **266 PSI (18 BAR)**

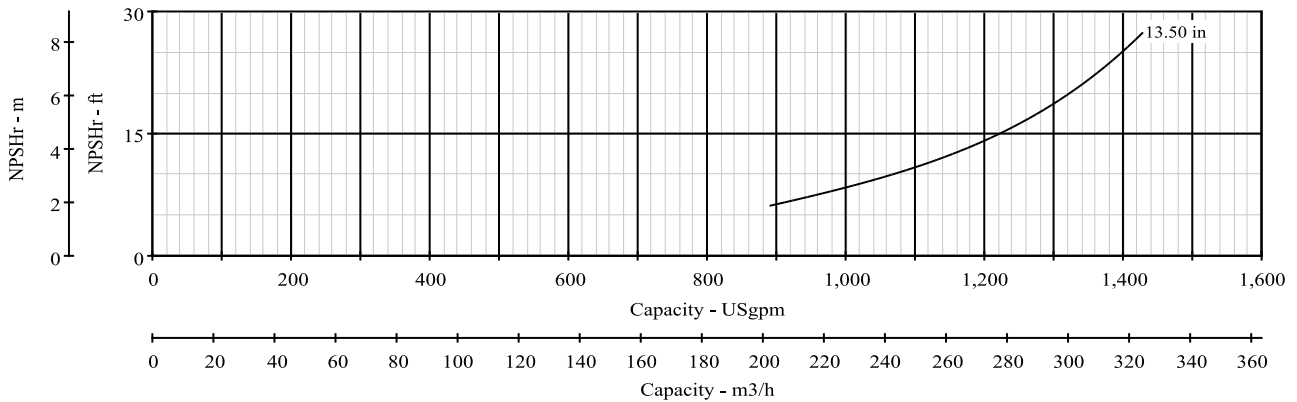
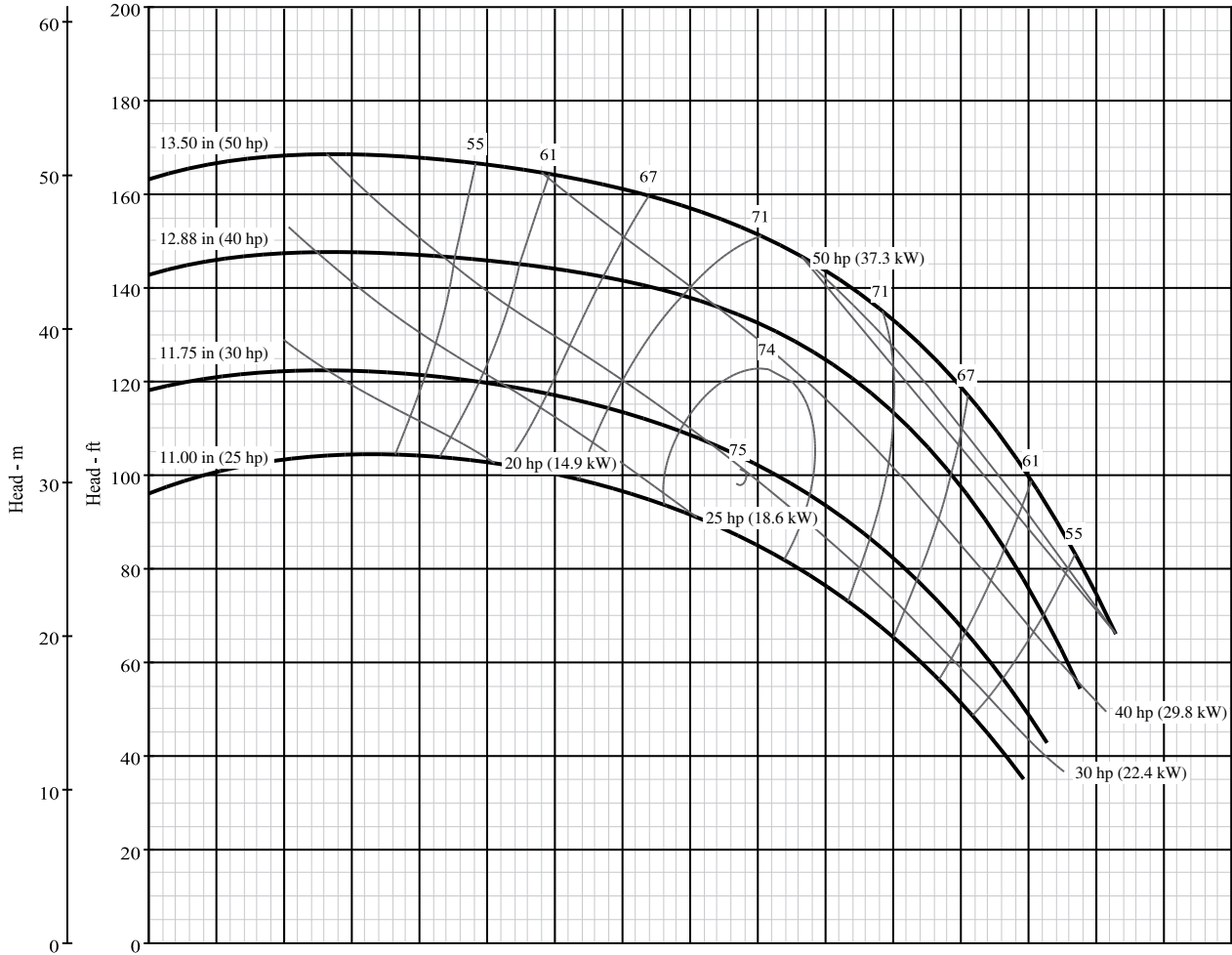

Pump Size: 6 x 8 x 13 BL

Model: B6J_BL

Curve No. 5026

Type	CCMD	FM CPLG	FM BELT	SAE	Hydraulic	AC Engine
Model	B6JPBL	B6JRMBL	B6JRMBL	B6JQBL		
RPM	1201-1800	1200-2200	1200-2100	1600-2200		

Dia. 13.50"

Nominal RPM: **VARIOUS**
 Based on Fresh Water @ 68°F (20°C)
 Maximum Working Pressure: 266 PSI (18 BAR)

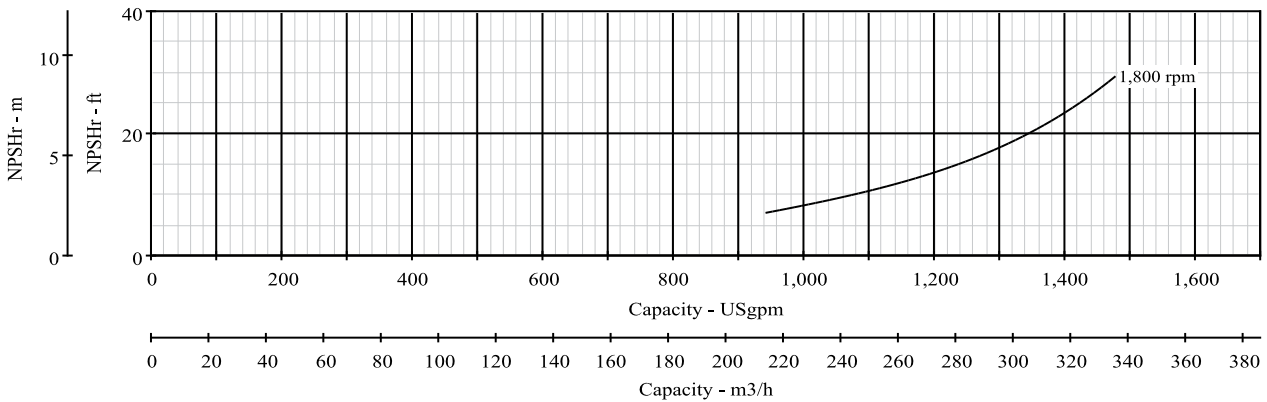
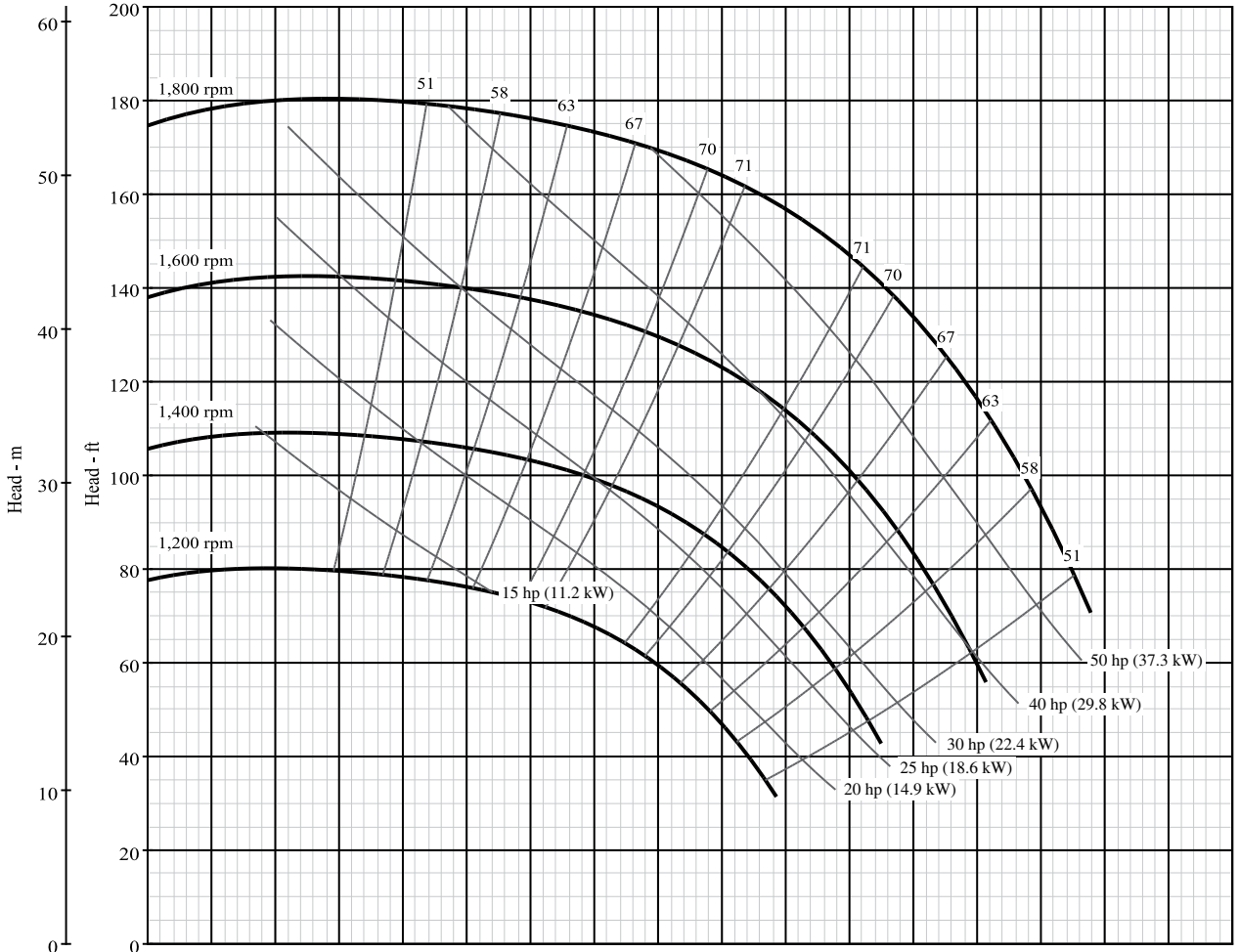

*NPSH data shown is at maximum speed

Pump Size: 6 x 8 x 13 BM

Model: B6J_BM

Curve No. 8851

Type	CCMD	FM CPLG	FM BELT	SAE	Hydraulic	AC Engine
Model	B6JPBM-CW	B6JRMBM-CCW	B6JRMBM-CCW			

Nominal RPM: **1750**
 Based on Fresh Water @ **68 °F (20 °C)**
 Maximum Working Pressure: **266 PSI (18 BAR)**

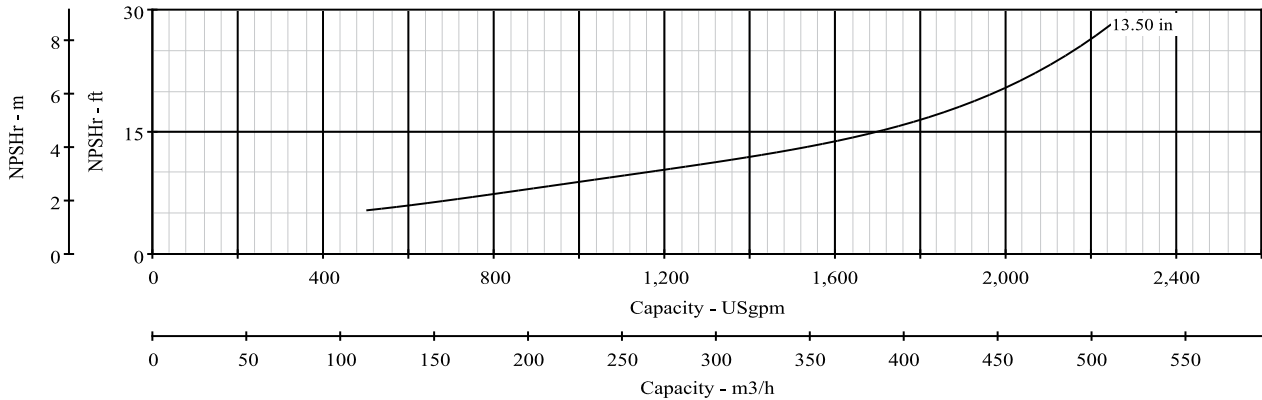
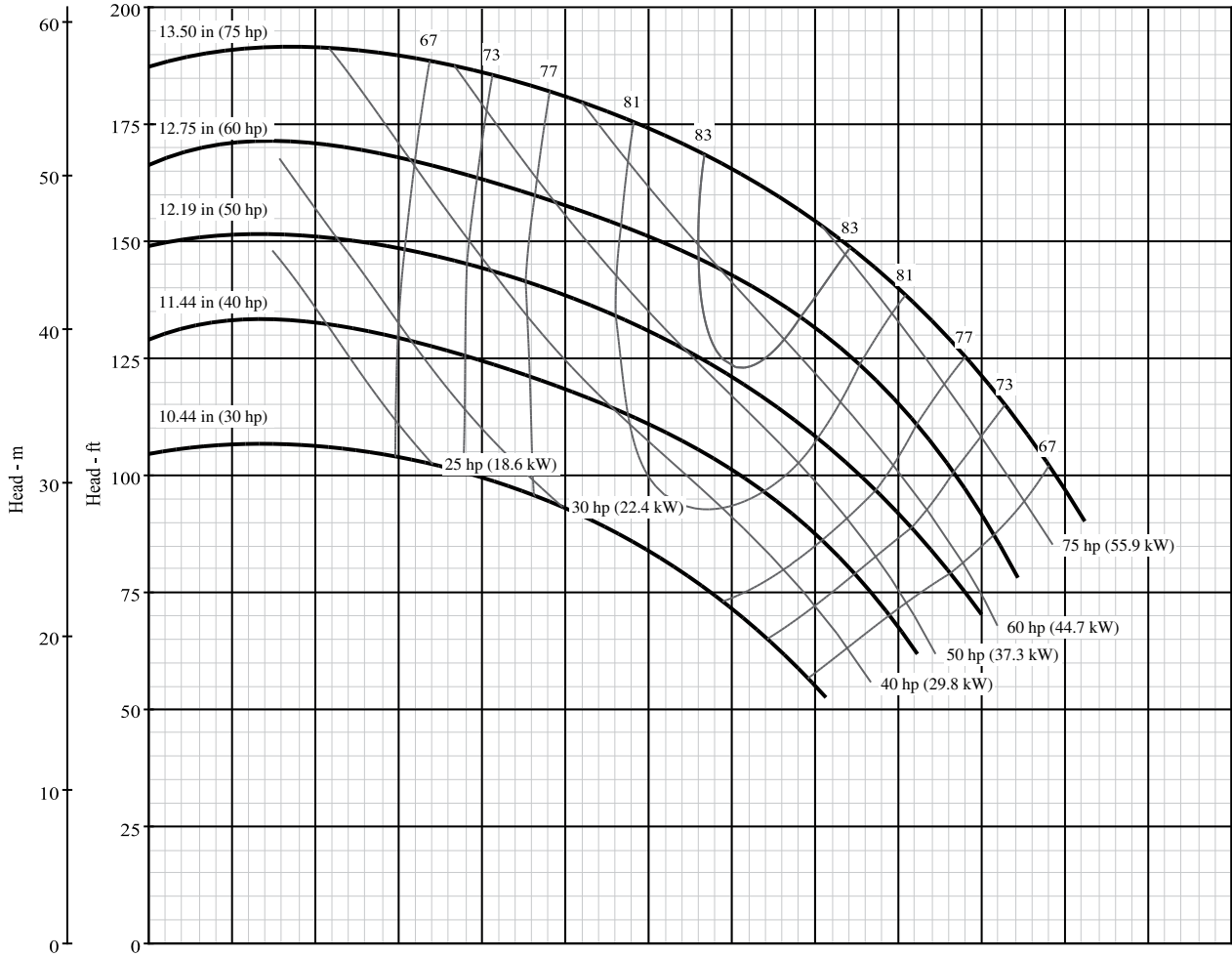

Pump Size: 6 x 8 x 13 BM

Model: B6J_BM

Curve No. 8851

Type	CCMD	FM CPLG	FM BELT	SAE	Hydraulic	AC Engine
Model	B6JPBM-CW	B6JRMBM-CCW	B6JRMBM-CCW			
RPM	901-1800	1200-2100	1200-1800			

Dia. 13.50"

Nominal RPM: **VARIOUS**
 Based on Fresh Water @ 68°F (20°C)
 Maximum Working Pressure: 266 PSI (18 BAR)

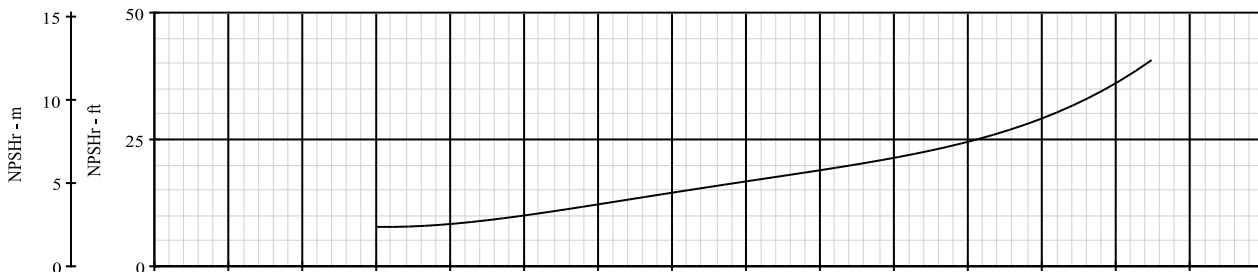
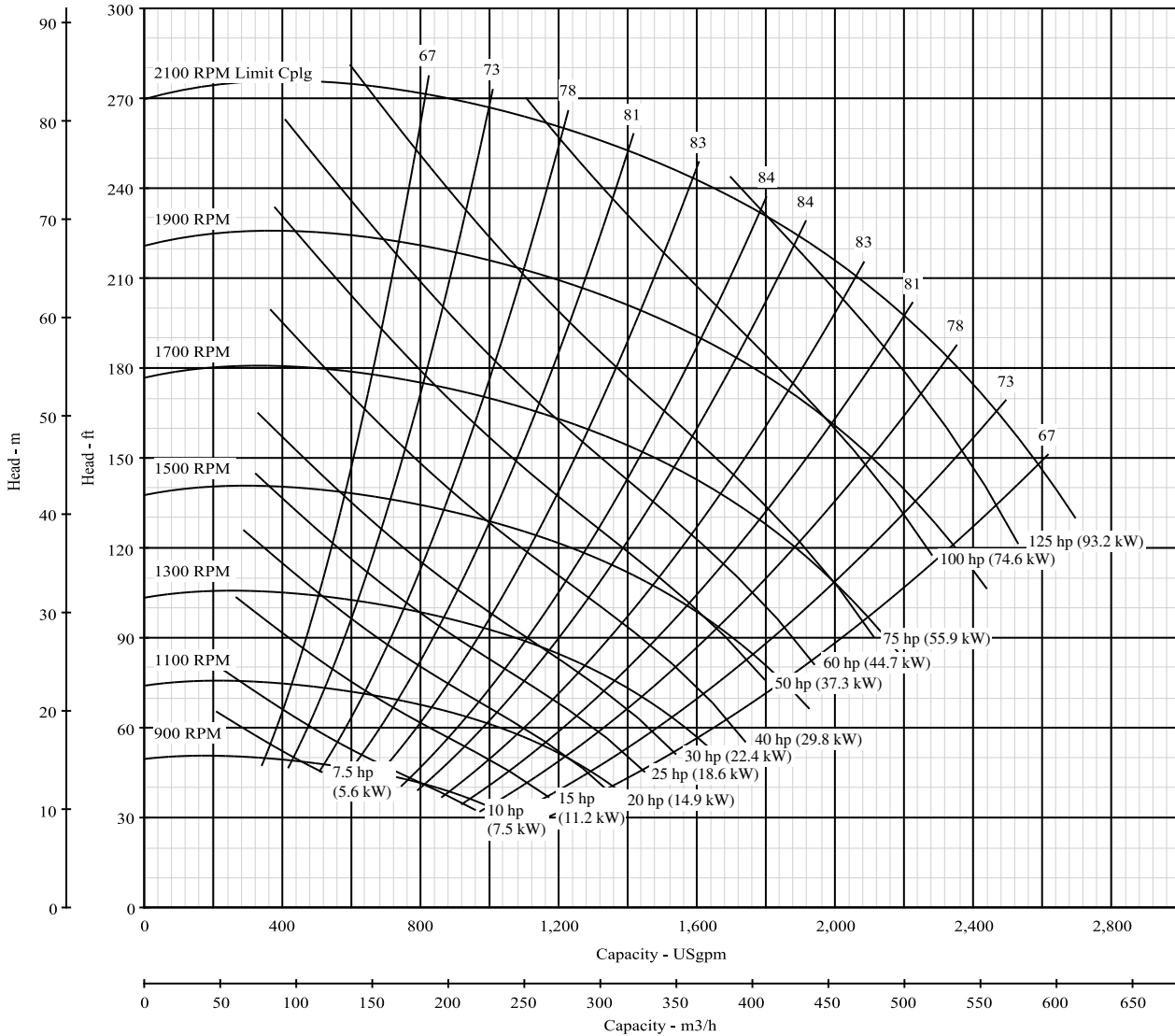

*NPSH data shown is at maximum speed

Pump Size:

Model: B6J_BM

Curve No. 8857

Type	CCMD	FM CPLG	FM BELT	SAE	Hydraulic	AC Engine
Model	B6JPBM	B6JRMBM	B6JRMBM	B6JQBM		

Nominal RPM: **1160**
 Based on Fresh Water @ **68°F (20°C)**
 Maximum Working Pressure: **266 PSI (18 BAR)**

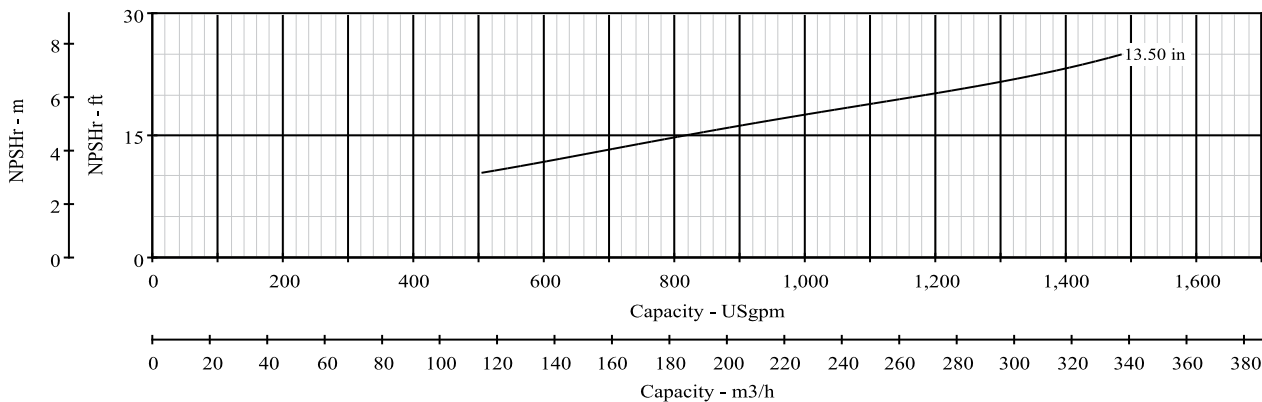
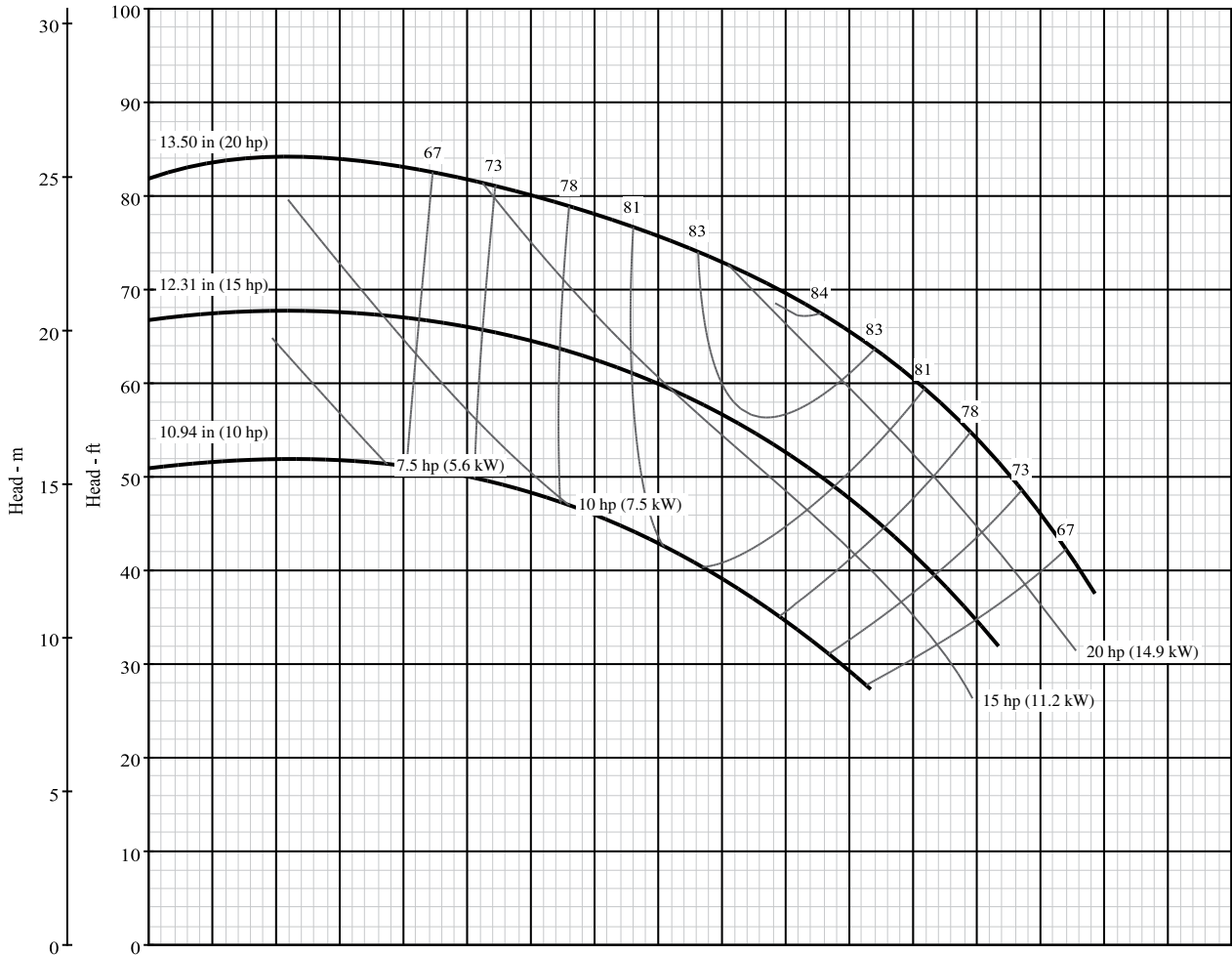

Pump Size: 6 x 8 x 13 BM

Model: B6J_BM-CW

Curve No. 8851A

Type	CCMD	FM CPLG	FM BELT	SAE	Hydraulic	AC Engine
Model		B6JRMBM-CW	B6JRMBM-CW	B6JQBM-CW		
RPM		1200-2100	1200-1800	1400-2200		

Dia. 13.50"

Nominal RPM: **VARIOUS**
 Based on Fresh Water @ 68°F (20°C)
 Maximum Working Pressure: 266 PSI (18 BAR)

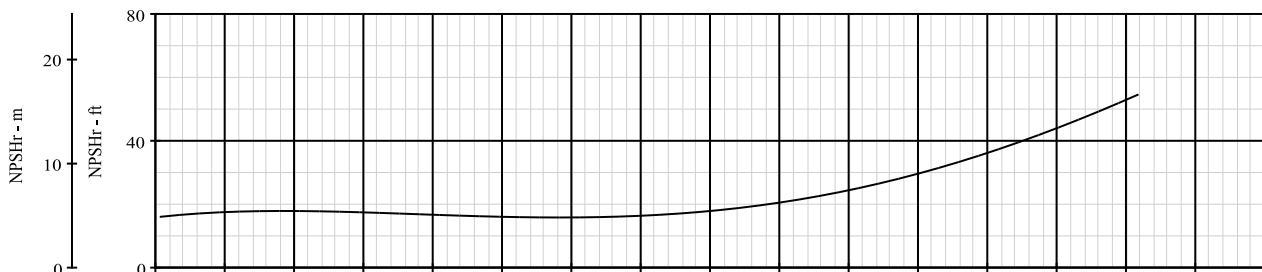
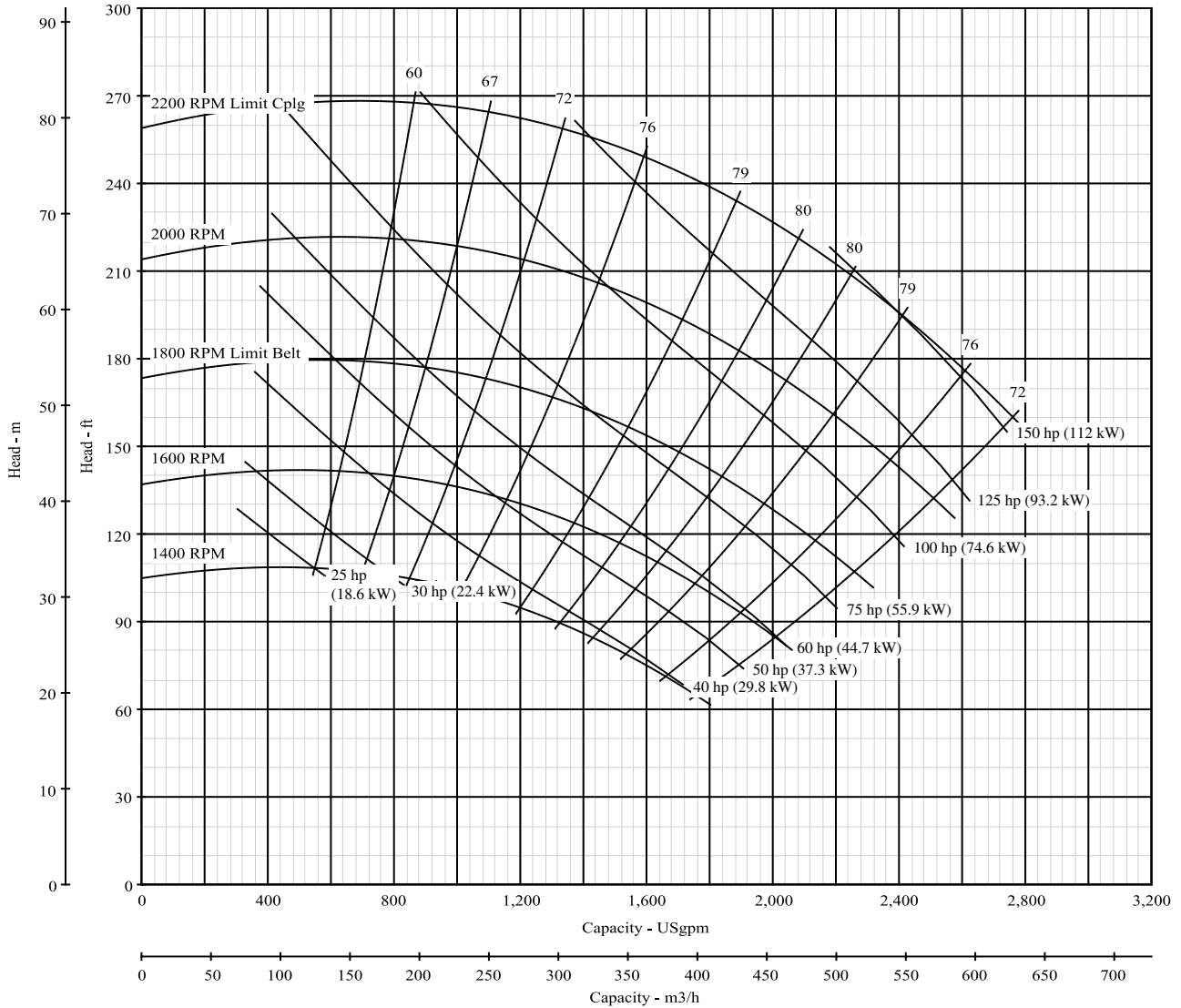

*NPSH data shown is at maximum speed

Pump Size: 6 x 8 x 13 BH

Model: B6J_BH

Curve No. 8934

Type	CCMD	FM CPLG	FM BELT	SAE	Hydraulic	AC Engine
Model	B6JPBH	B6JRMBH				

Nominal RPM: **1760**
 Based on Fresh Water @ **68°F (20°C)**
 Maximum Working Pressure: **266 PSI (18 BAR)**

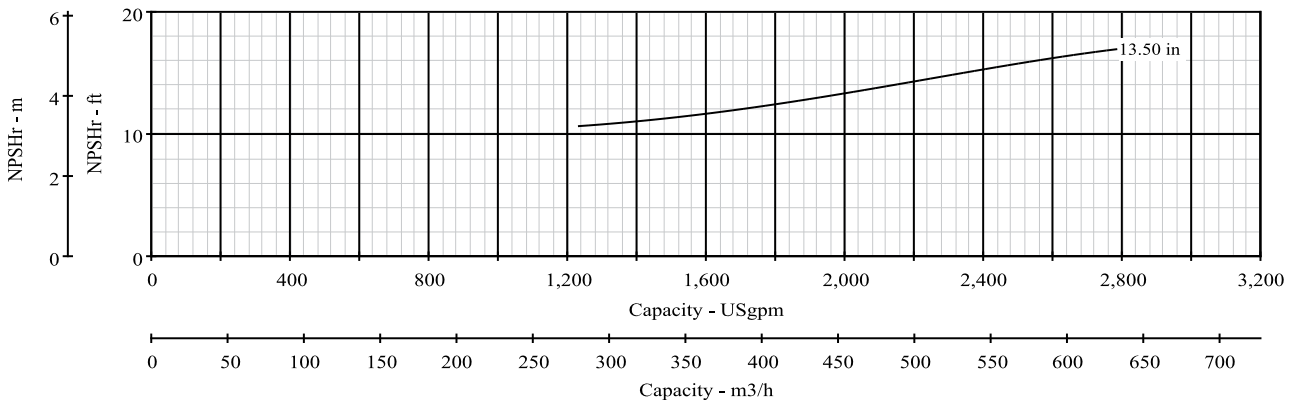
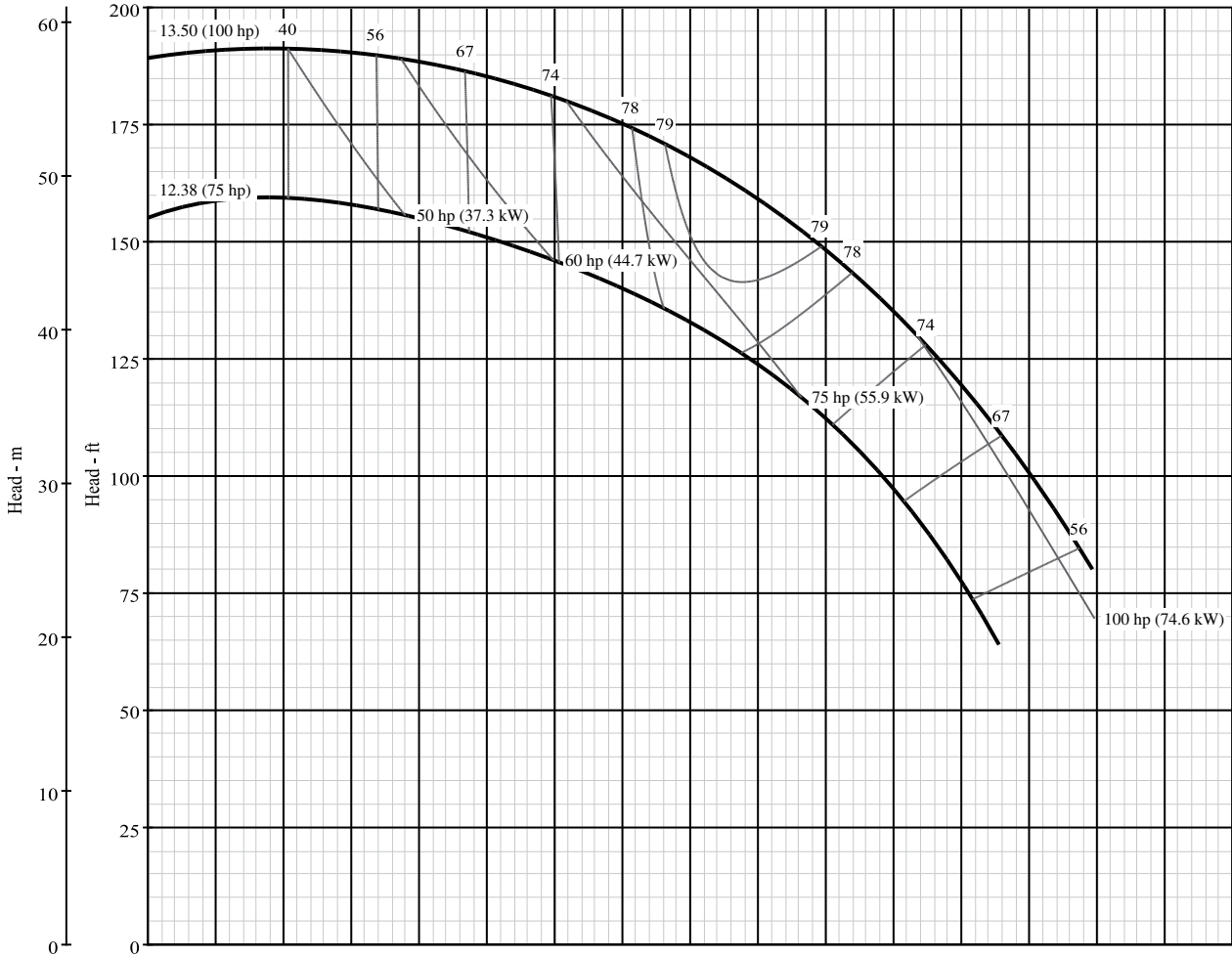

Pump Size: 6 x 8 x 13 BH

Model: B6J_BH

Curve No. 8934

Type	CCMD	FM CPLG	FM BELT	SAE	Hydraulic	AC Engine
Model	B6JPBH	B6JRMBH	B6JRMBH			
RPM	1201-1800	1400-2000	1400-1700			

Full Dia: 13.50"

Nominal RPM: **VARIOUS**
 Based on Fresh Water @ 68°F (20°C)
 Maximum Working Pressure: 266 PSI (18 BAR)

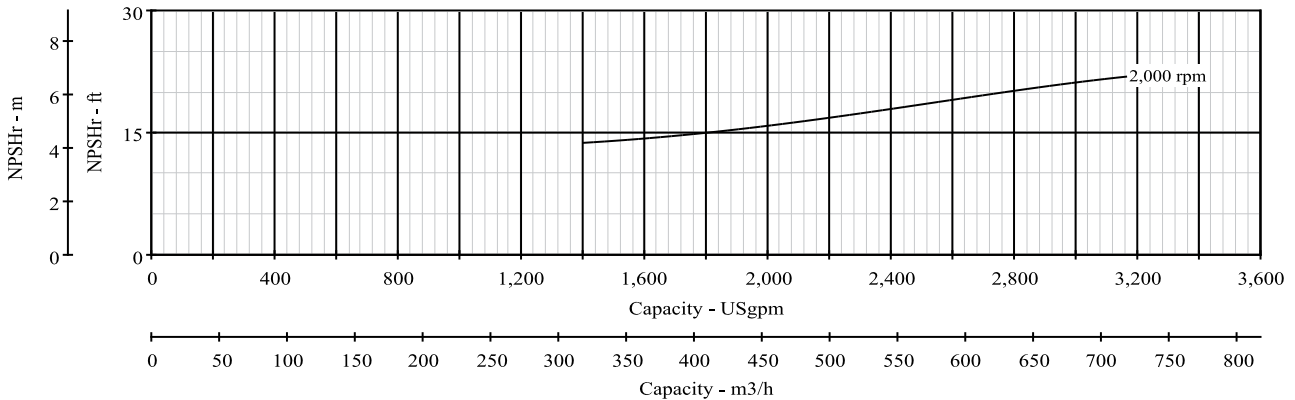
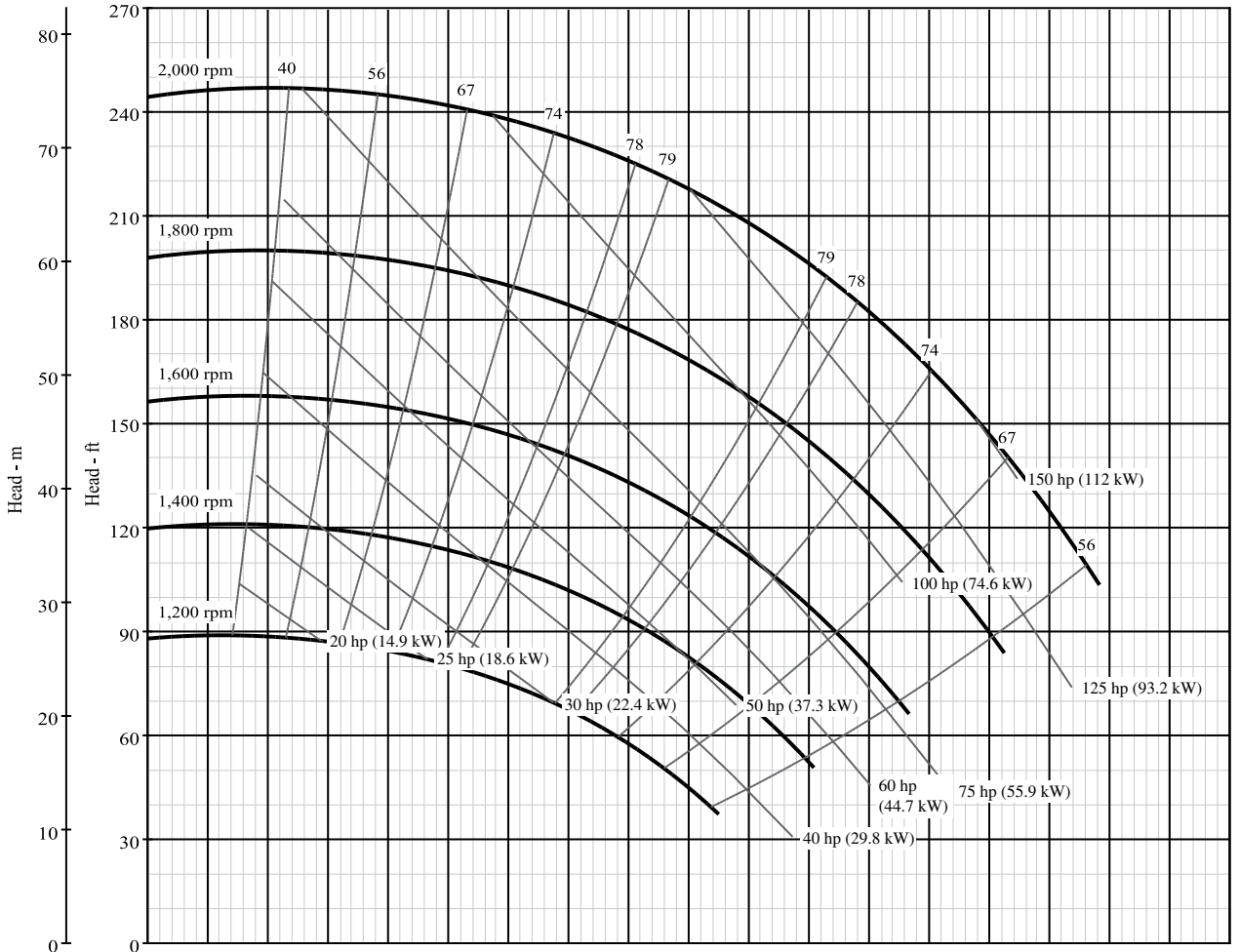

*NPSH data shown is at maximum speed

Pump Size: 8 x 10 x 13.5

Model: B8J_BH

Curve No.

Type	CCMD	FM CPLG	FM BELT	SAE	Hydraulic	AC Engine
Model	B8JPBH(S)	B8JRBH(S)	B8JRBH(S)	B8JQBH(S)		

Nominal RPM: **1770**
 Based on Fresh Water @ **68°F (20°C)**
 Maximum Working Pressure: **175 PSI (12 BAR)**

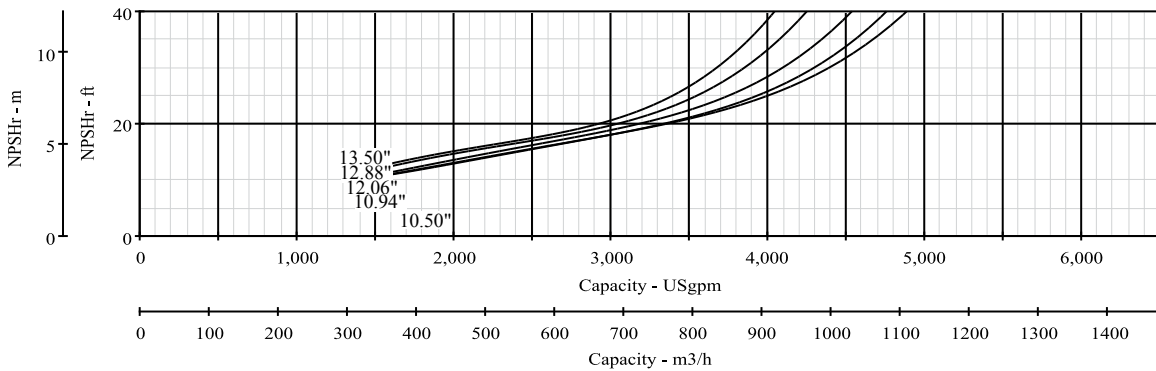
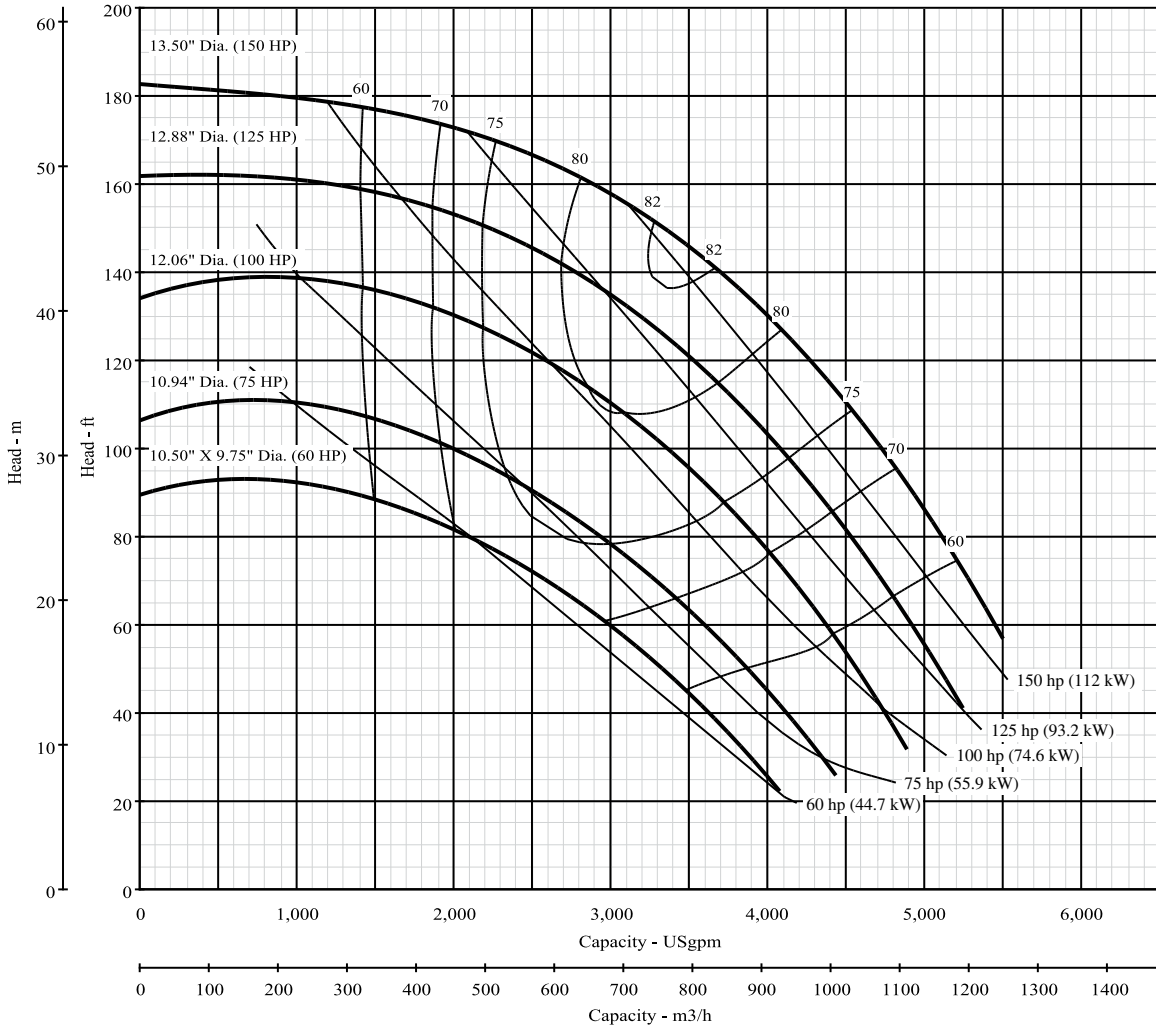

Pump Size: 8 x 10 x 13.5

Model: B8J_BH

Curve No.

Type	CCMD	FM CPLG	FM BELT	SAE	Hydraulic	AC Engine
Model	B8JPBH(S)	B8JRBH(S)	B8JRBH(S)	B8JQBH(S)		

Full Dia: 13.5"

Nominal RPM: **VARIOUS**
 Based on Fresh Water @ 68°F (20°C)
 Maximum Working Pressure: 175 PSI (12 BAR)

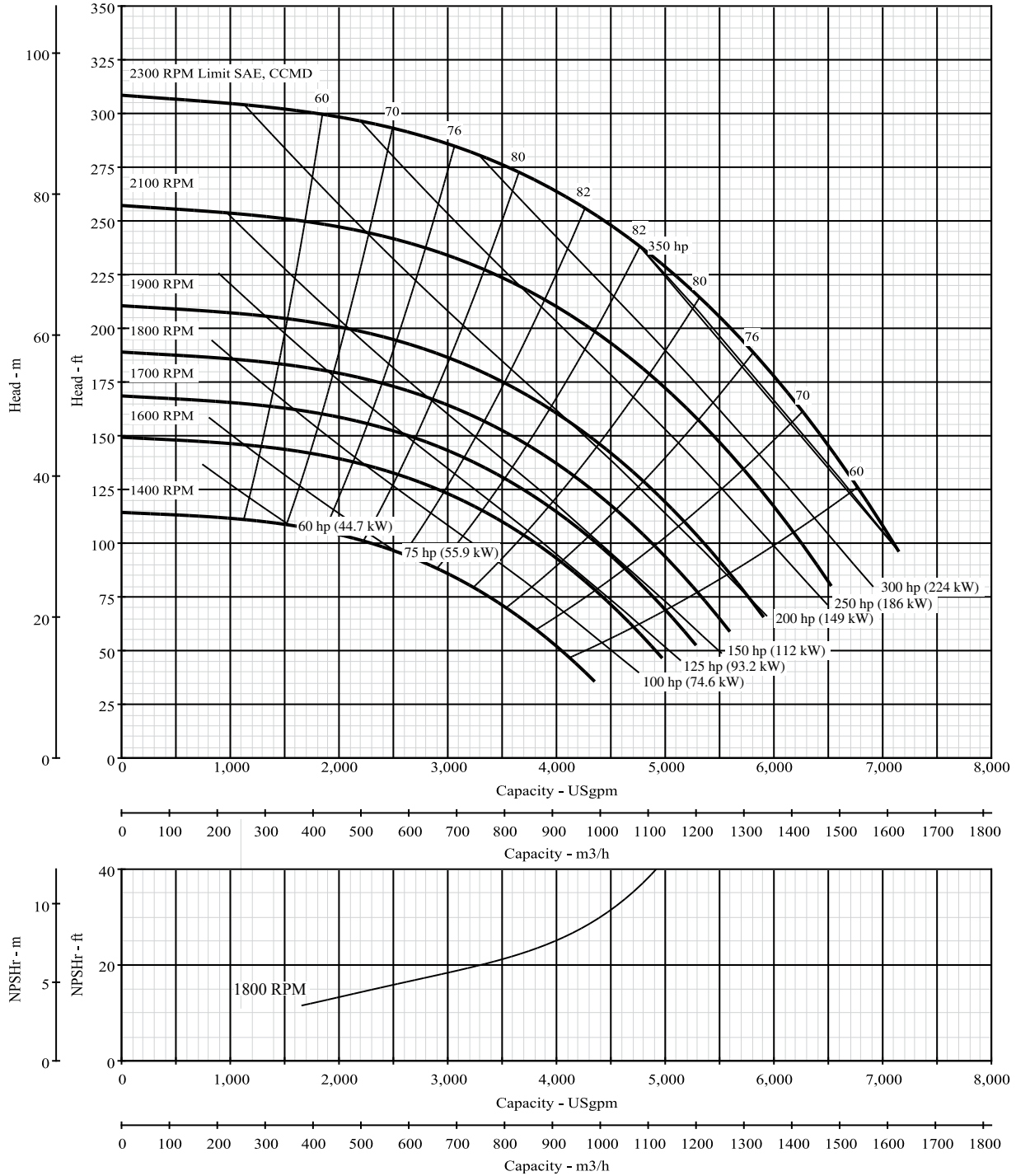

Pump Size: 10 x 12 x 13.5

Model: B10J_BH

Curve No.

Type	CCMD	FM CPLG	FM BELT	SAE	Hydraulic	AC Engine
Model	B10JPBH(S)	B10JRBH(S)	B10JRBH(S)	B10JQBH(S)		

Nominal RPM: **1770**
 Based on Fresh Water @ **68°F (20°C)**
 Maximum Working Pressure: **175 PSI (12 BAR)**

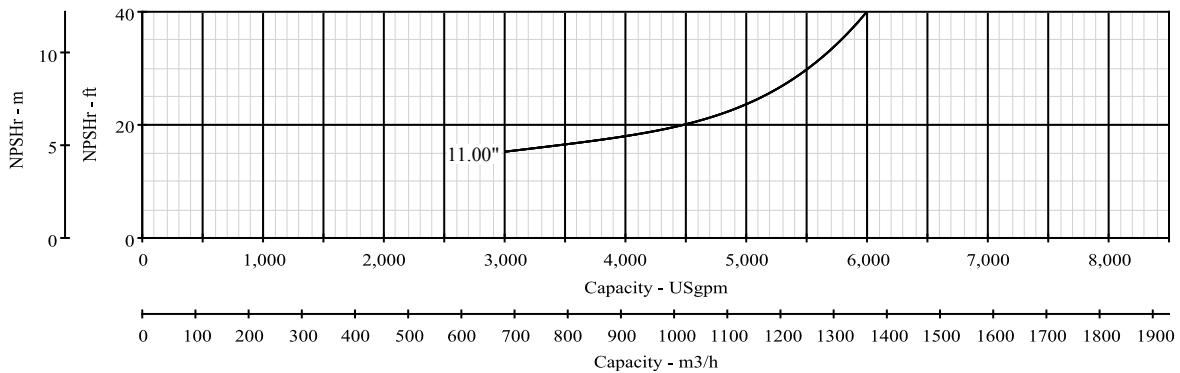
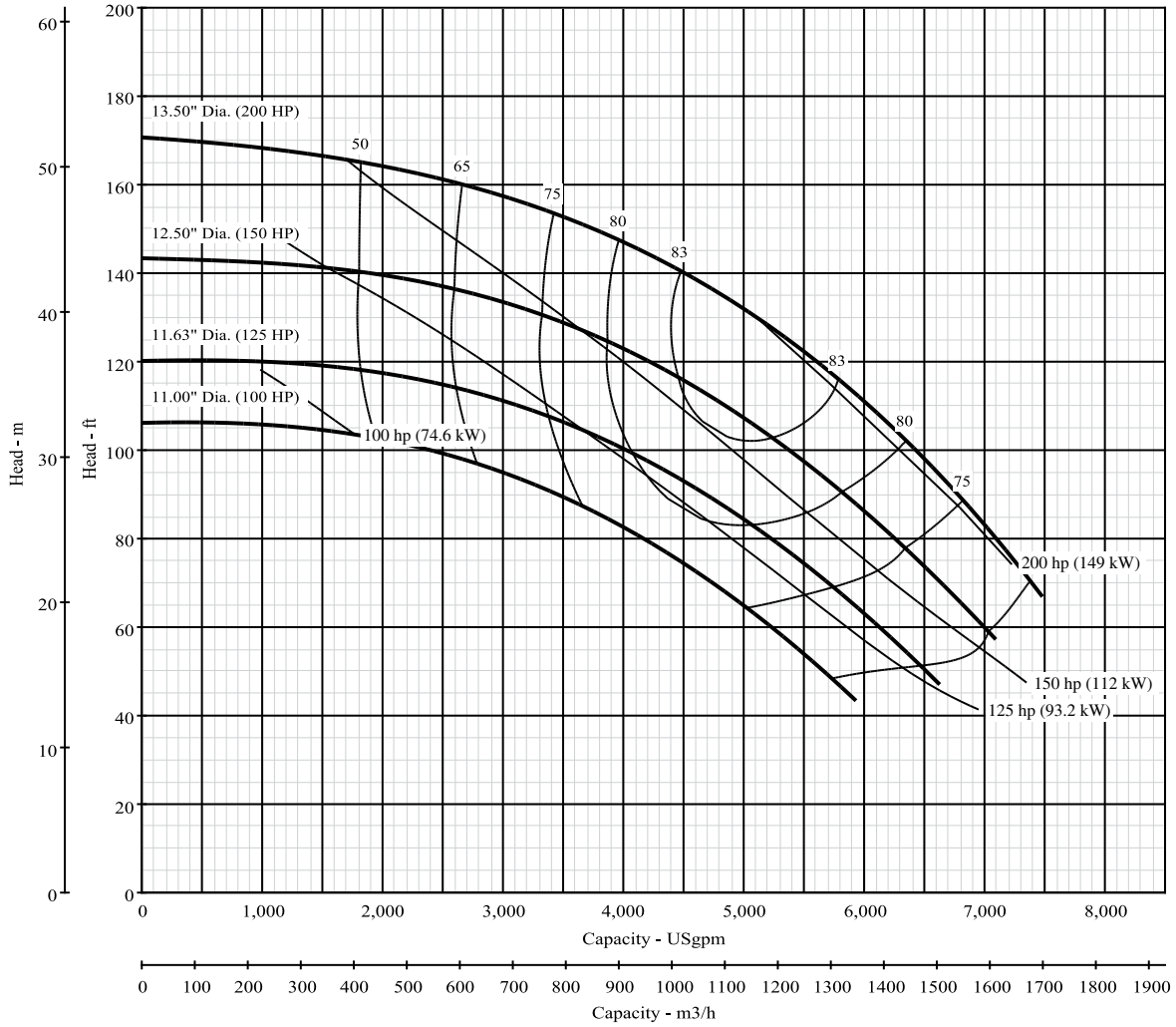

Pump Size: 10 x 12 x 13.5

Model: B10J_BH

Curve No.

Type	CCMD	FM CPLG	FM BELT	SAE	Hydraulic	AC Engine
Model	B10JPBH(S)	B10JRBH(S)	B10JRBH(S)	B10JQBH(S)		

Full Dia: 13.5"

Nominal RPM: **VARIOUS**
 Based on Fresh Water @ 68°F (20°C)
 Maximum Working Pressure: 175 PSI (12 BAR)

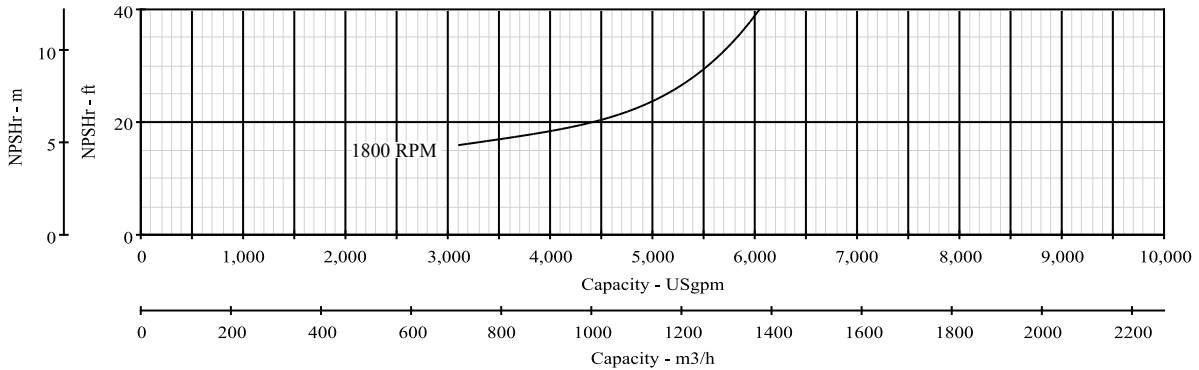
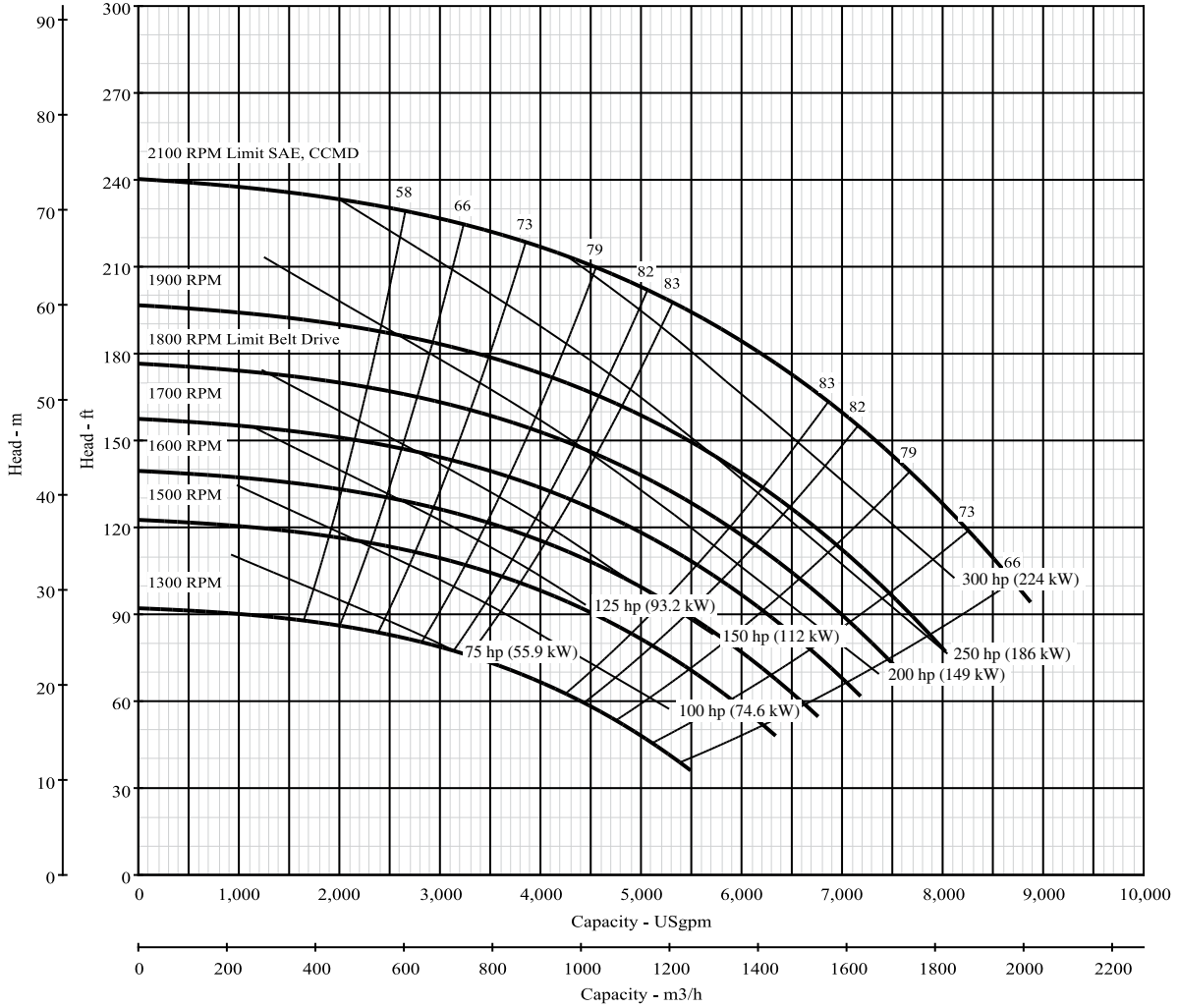

Pump Size: 4 x 5 x 15 BL

Model: B4EX_BL

Curve No. 9112

Type	CCMD	FM CPLG	FM BELT	SAE	Hydraulic	AC Engine
Model	B4EXPBL			B4EXQBL		

Nominal RPM: **1770**
 Based on Fresh Water @ **68°F (20°C)**
 Maximum Working Pressure: 266 PSI (18 BAR)

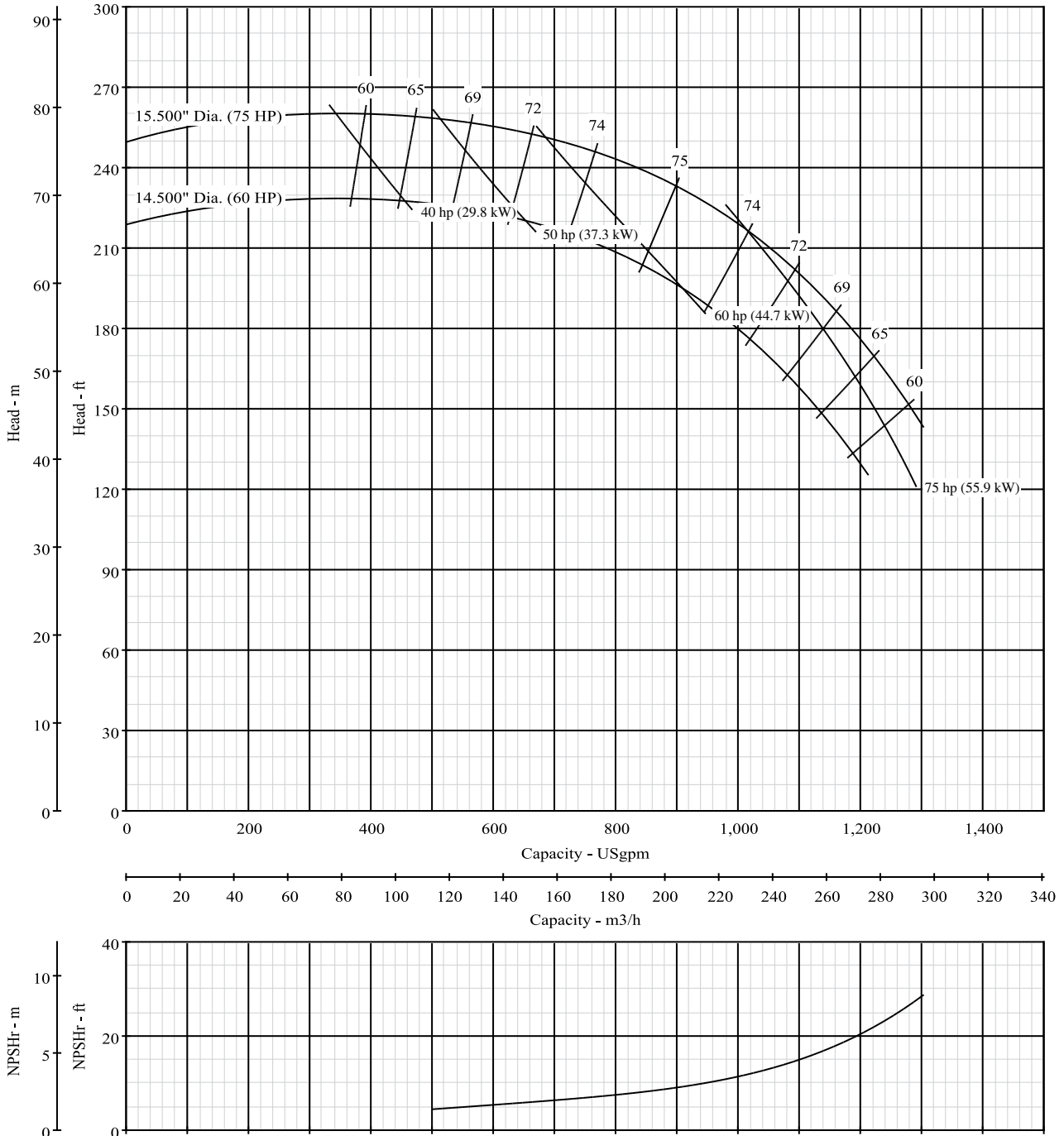

Pump Size: 4 x 5 x 15 BL

Model: B4EX_BL

Curve No. 9112

Type	CCMD	FM CPLG	FM BELT	SAE	Hydraulic	AC Engine
Model	B4EXPBL			B4EXQBL		
RPM	1201-1800			1600-2200		

Dia. 15.50"

Nominal RPM: **VARIOUS**
 Based on Fresh Water @ 68°F (20°C)
 Maximum Working Pressure: 266 PSI (18 BAR)

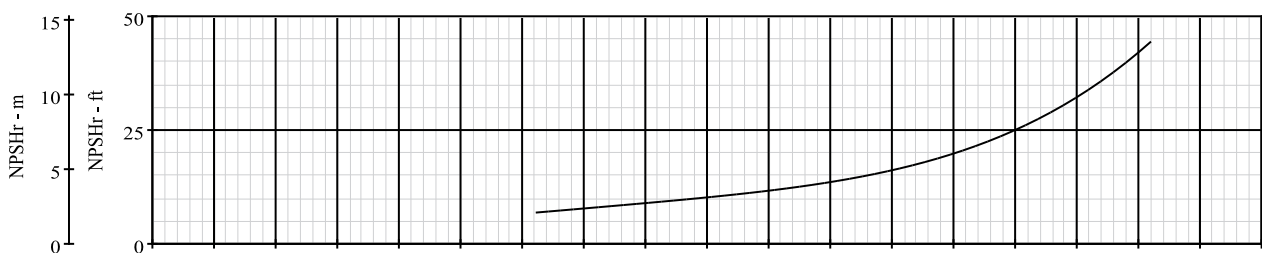
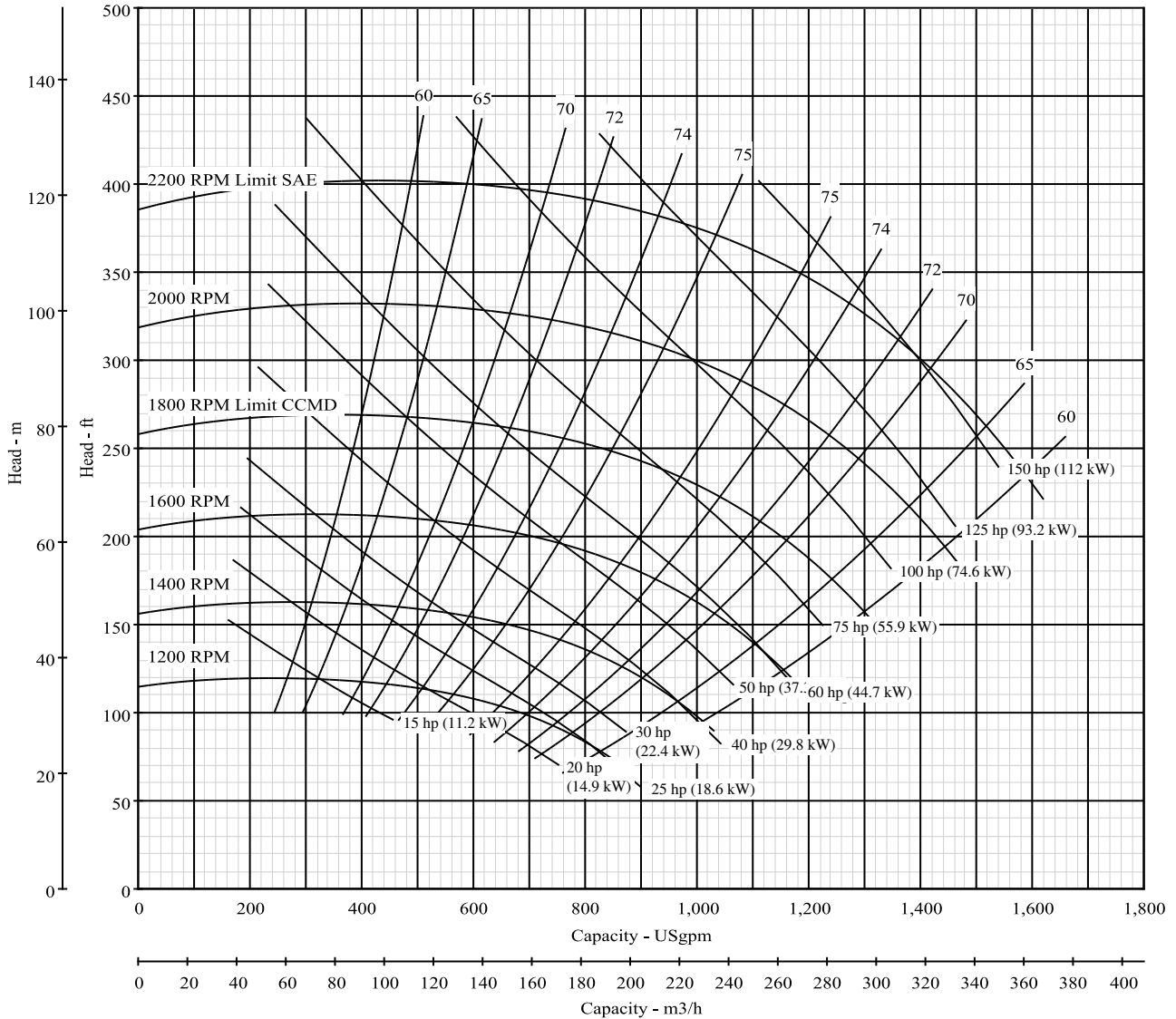

*NPSH data shown is at maximum speed

Pump Size: 5 x 6 x 15 BH

Model: B5EX_BH

Curve No. 8443

Type	CCMD	FM CPLG	FM BELT	SAE	Hydraulic	AC Engine
Model	B5EXPBH			B5EXQBHS		

Nominal RPM: **1770**
 Based on Fresh Water @ **68°F (20°C)**
 Maximum Working Pressure: **266 PSI (18 BAR)**

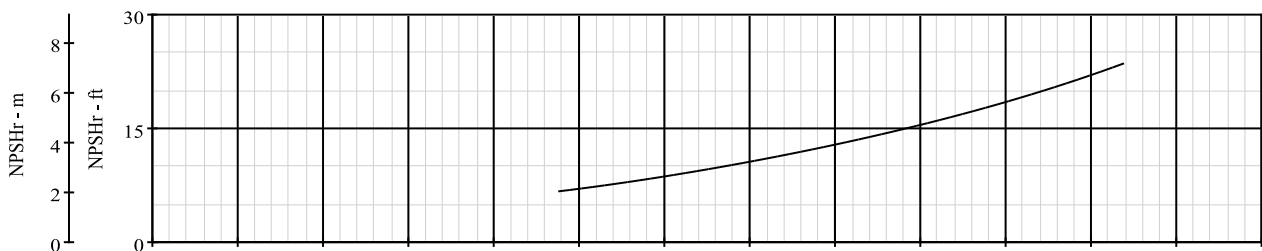
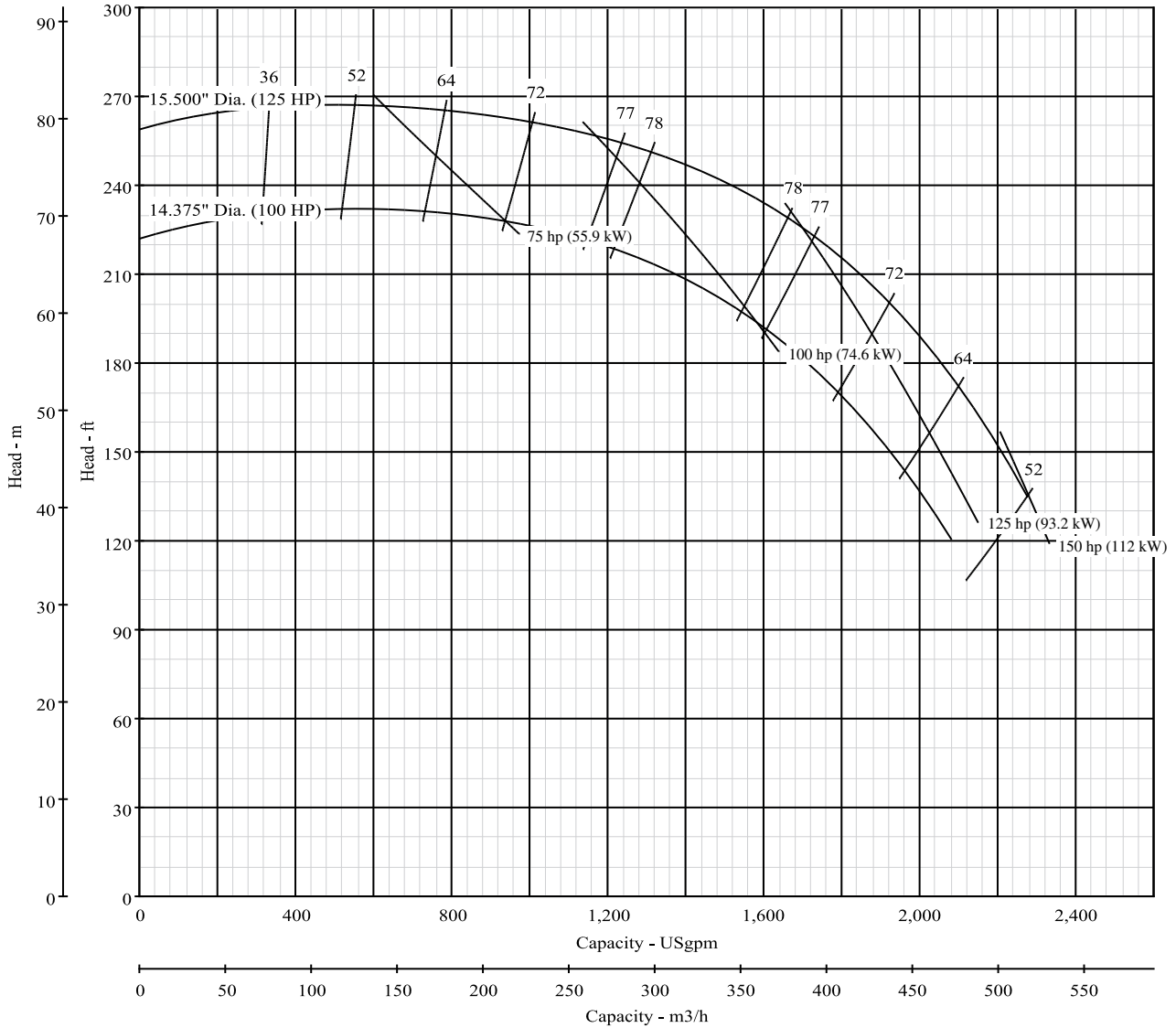

Pump Size: 5 x 6 x 15 BH

Model: B5EX_BH

Curve No. 8443

Type	CCMD	FM CPLG	FM BELT	SAE	Hydraulic	AC Engine
Model	B5EXPBH			B5EXQBHS		
RPM	1201-1800			1600-2300		

Dia. 15.50"

Nominal RPM: **VARIOUS**
 Based on Fresh Water @ 68°F (20°C)
 Maximum Working Pressure: 266 PSI (18 BAR)

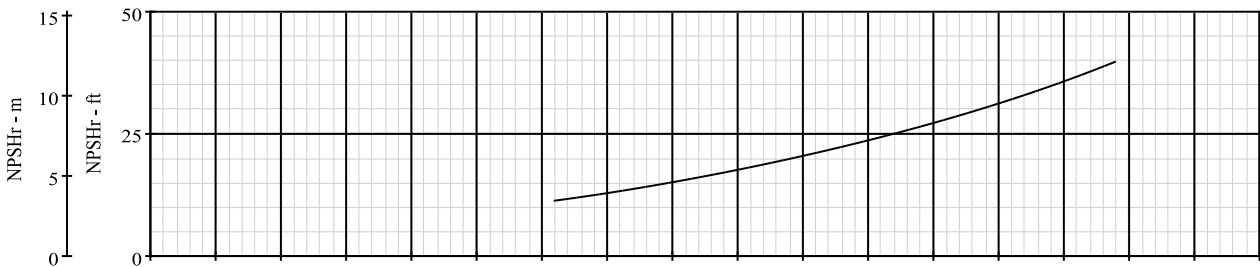
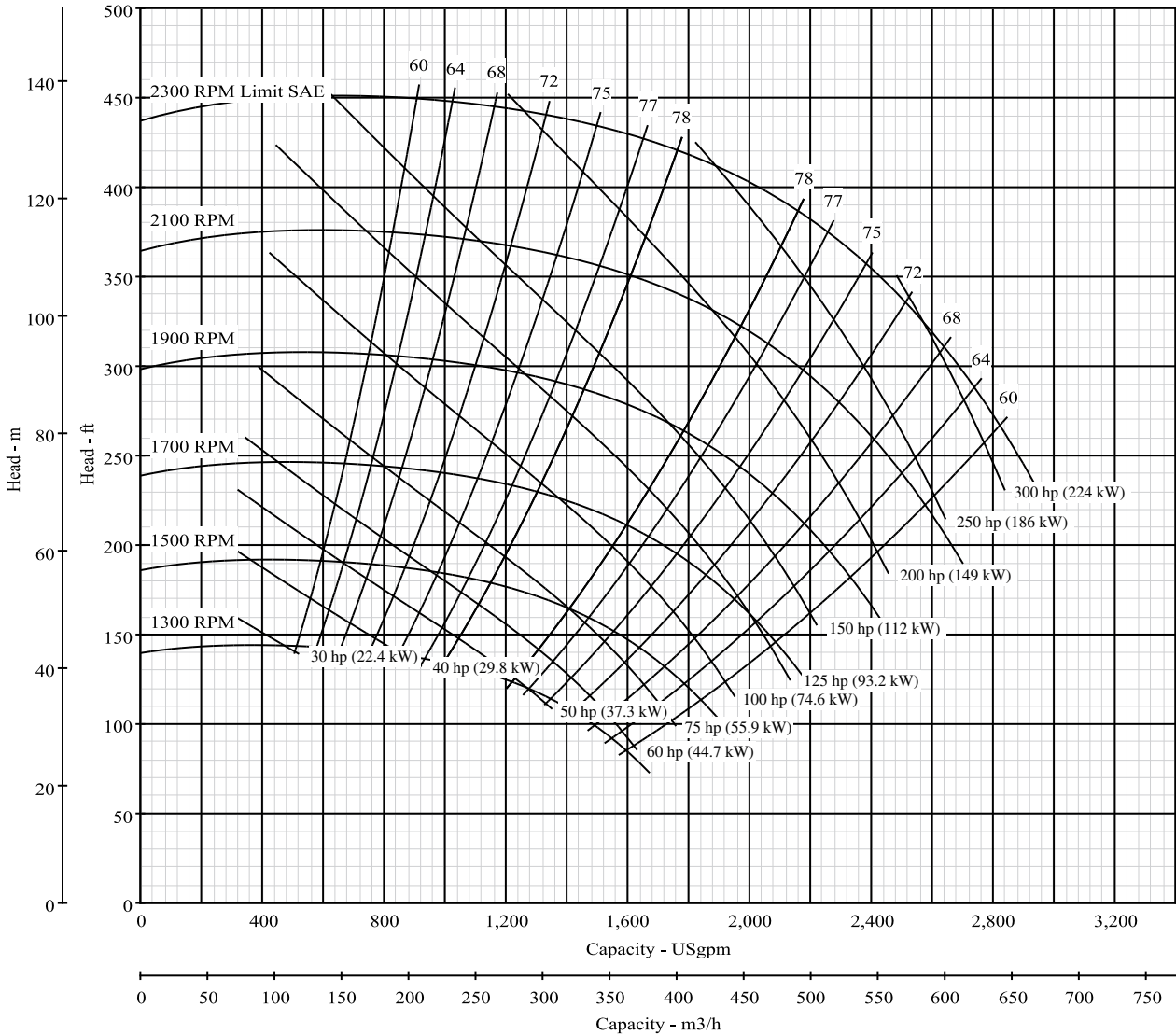

*NPSH data shown is at maximum speed

Pump Size: 6 x 8 x 15 BL

Model: B6EX_BL

Curve No. 7452

Type	CCMD	FM CPLG	FM BELT	SAE	Hydraulic	AC Engine
Model	B6EXPBL	B6EXRBL	B6EXRBL			

Nominal RPM: **1770**
 Based on Fresh Water @ 68°F (20°C)
 Maximum Working Pressure: 266 PSI (18 BAR)

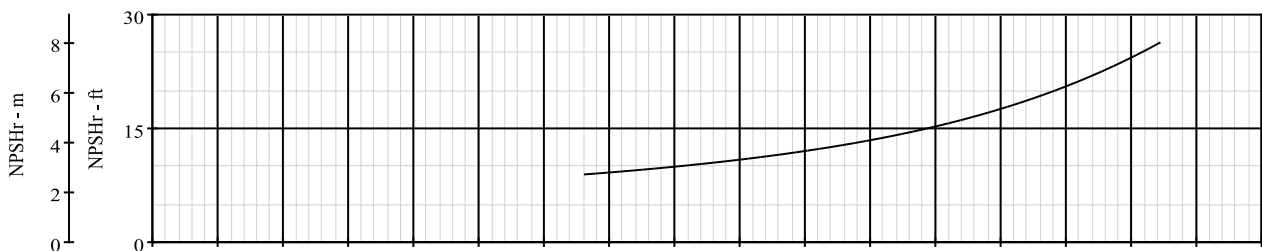
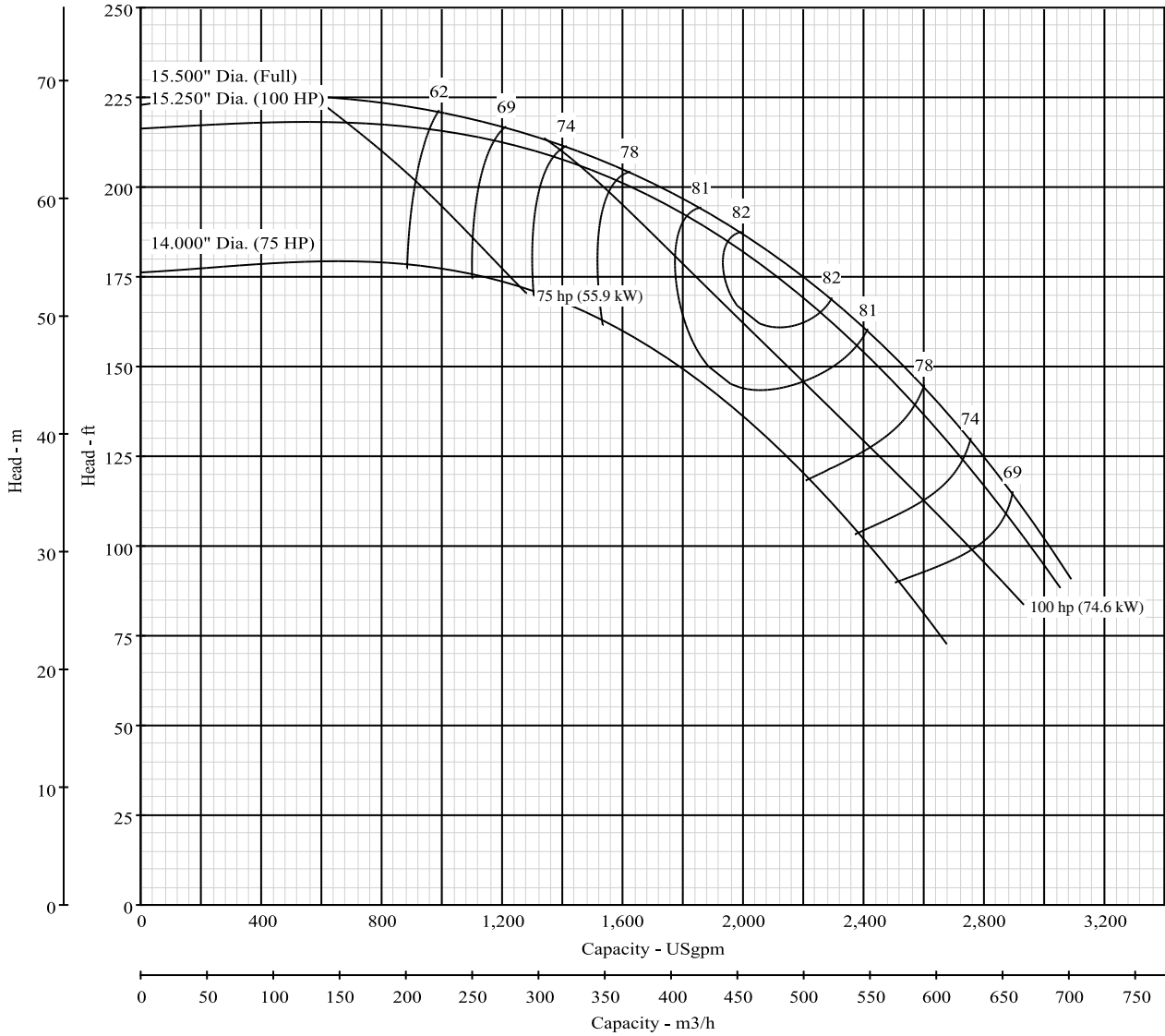

Pump Size: 6 x 8 x 15 BL

Model: B6EX_BL

Curve No. 7452

Type	CCMD	FM CPLG	FM BELT	SAE	Hydraulic	AC Engine
Model	B6EXPBL	B6EXRBL	B6EXRBL			
RPM	1201-1800	1200-2000	1200-1800			

Dia. 15.50"

Nominal RPM: **VARIOUS**
 Based on Fresh Water @ 68°F (20°C)
 Maximum Working Pressure: 266 PSI (18 BAR)

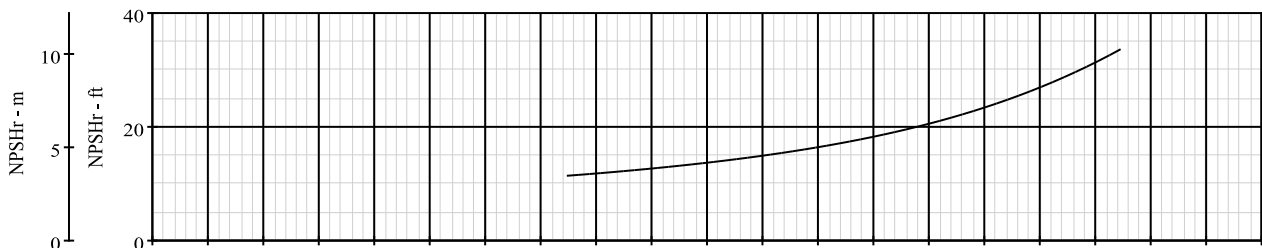
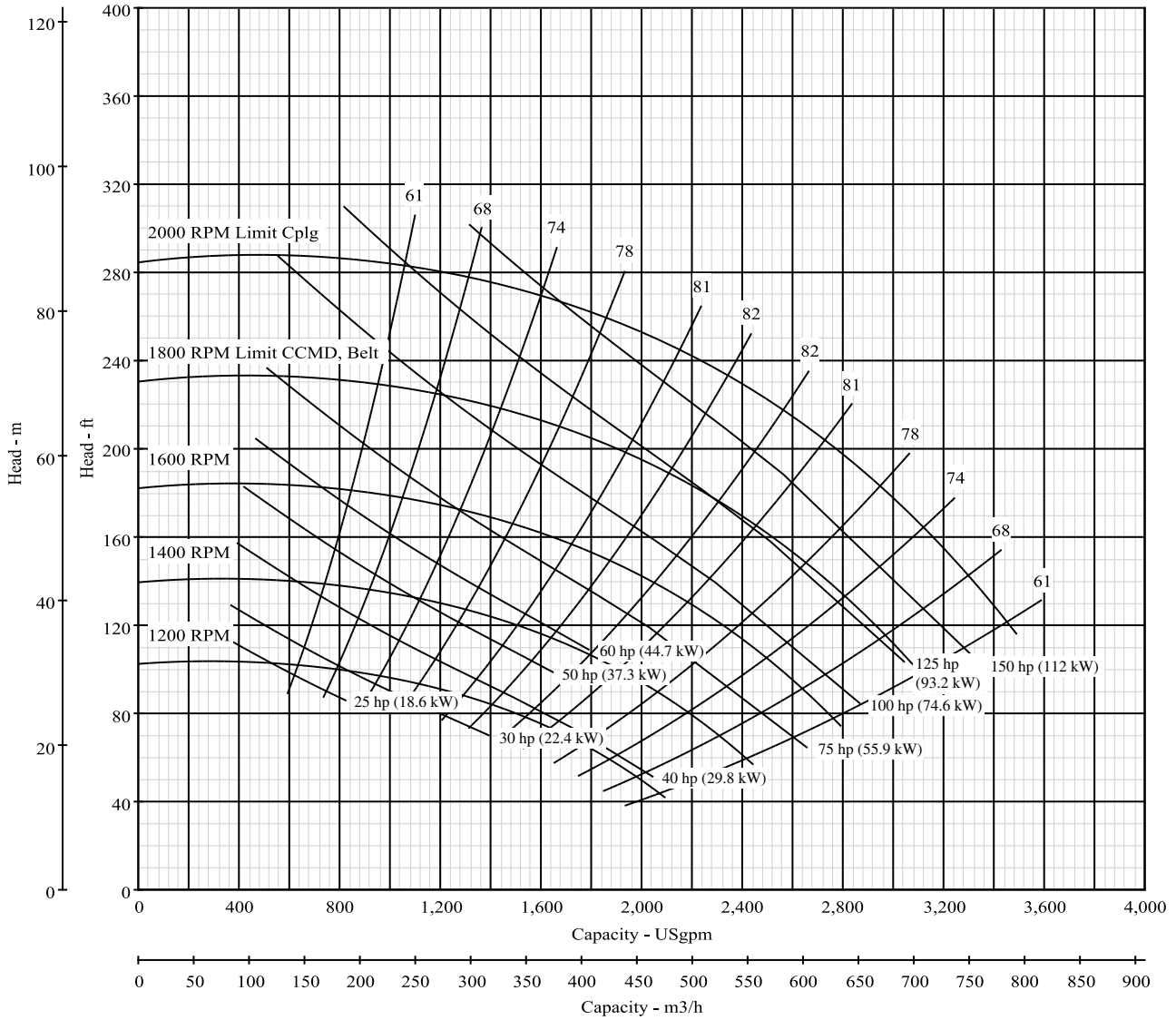

*NPSH data shown is at maximum speed

Pump Size: 6 x 8 x 15 BM

Model: B6EX_BM

Curve No. 8856

Type	CCMD	FM CPLG	FM BELT	SAE	Hydraulic	AC Engine
Model				B6EXQBM		
RPM				1600-2000		

Dia. 13.50"

Nominal RPM: **VARIOUS**
 Based on Fresh Water @ 68°F (20°C)
 Maximum Working Pressure: 266 PSI (18 BAR)

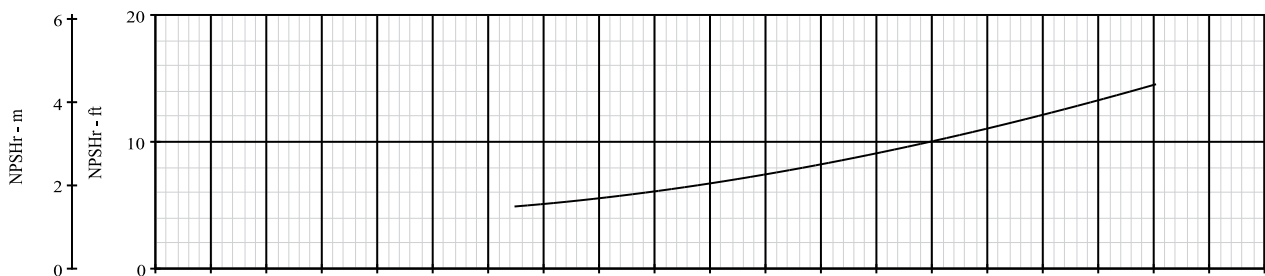
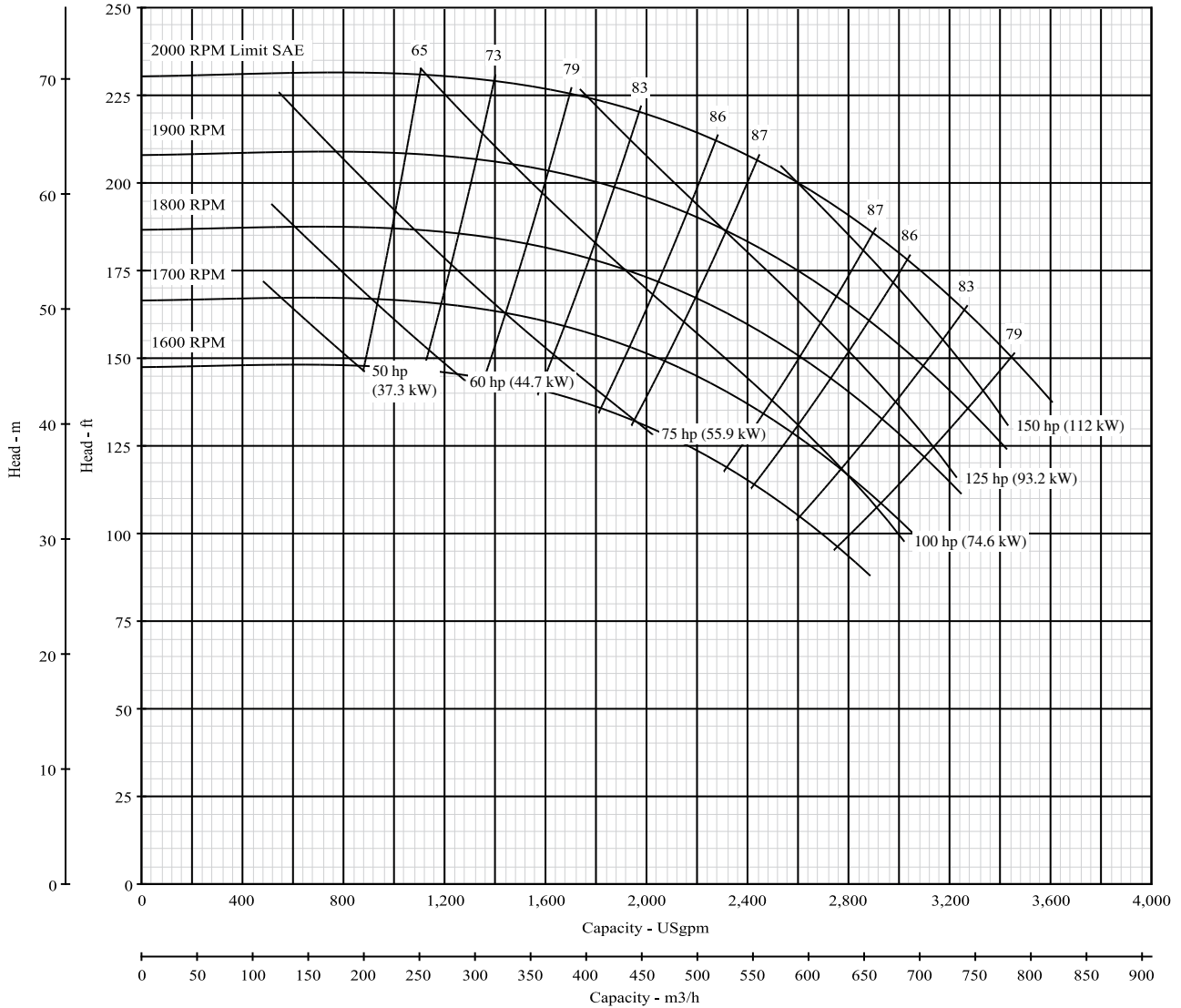

Pump Size: 6 x 8 x 15 BH

Model: B6EX_BH

Curve No. 8845

Type	CCMD	FM CPLG	FM BELT	SAE	Hydraulic	AC Engine
Model	B6EXPBH	B6EXRBH				

Nominal RPM: **1770**
 Based on Fresh Water @ **68°F (20°C)**
 Maximum Working Pressure: **266 PSI (18 BAR)**

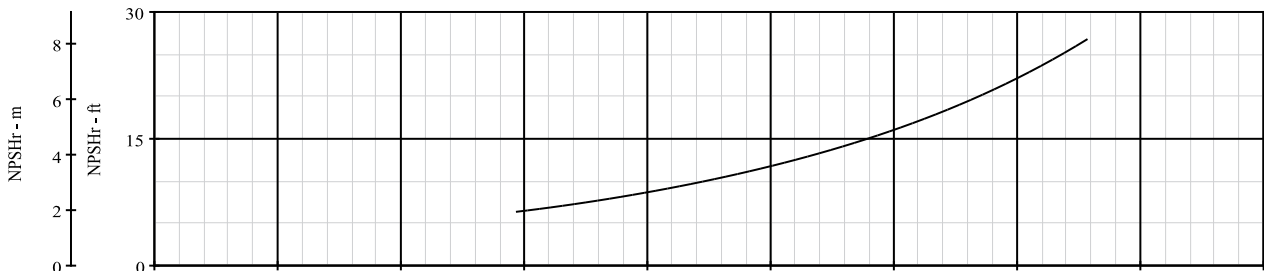
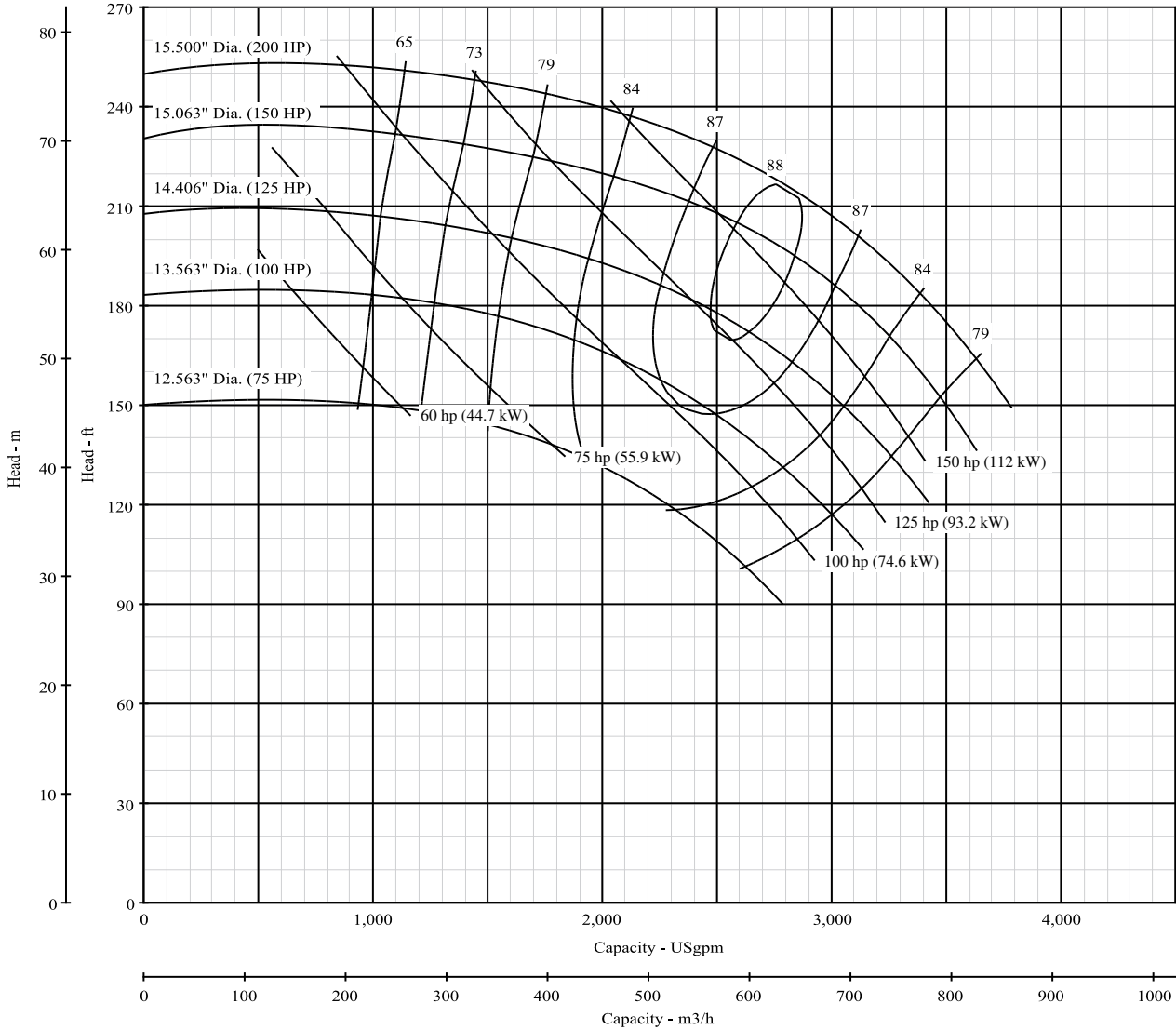

Pump Size: 6 x 8 x 15 BH

Model: B6EX_BH

Curve No. 8845

Type	CCMD	FM CPLG	FM BELT	SAE	Hydraulic	AC Engine
Model	B6EXPBH	B6EXRBH	B6EXRBH			
RPM	1201-1800	1400-1900	1400-1700			

Dia. 15.50"

Nominal RPM: **VARIOUS**
 Based on Fresh Water @ 68°F (20°C)
 Maximum Working Pressure: 266 PSI (18 BAR)

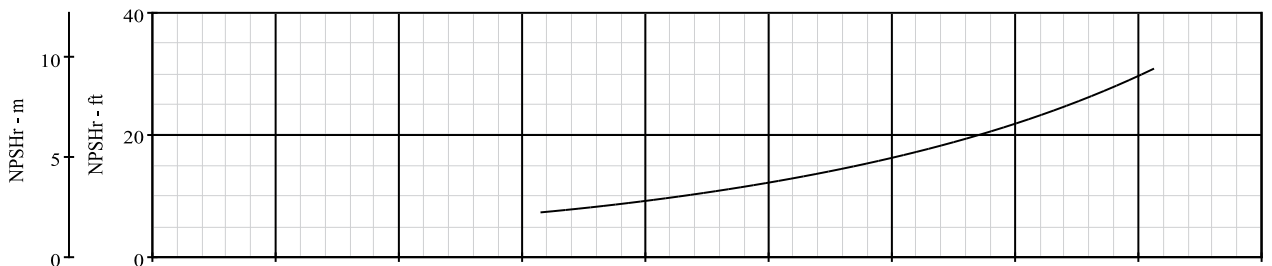
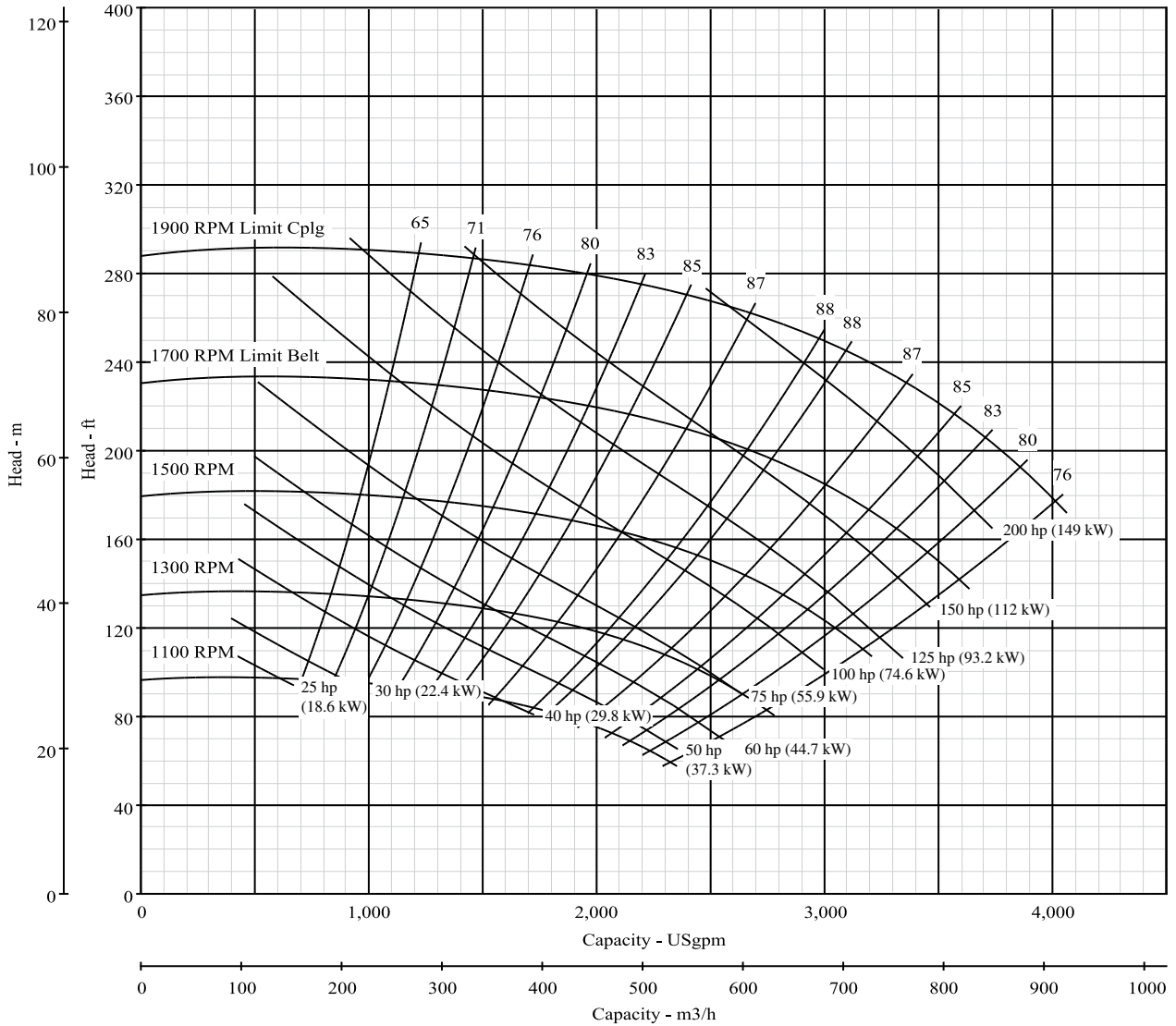

Pump Size: 6 x 8 x 15.5 BH

Model: B6XT_BH-15.5"

Curve No. 3333A

Type	CCMD	FM CPLG	FM BELT	SAE	Hydraulic	AC Engine
Model				B6XTQBH-15.5"		
RPM				1600-1900		

Dia. 15.50"

Nominal RPM: **VARIOUS**
 Based on Fresh Water @ 68 °F (20 °C)
 Maximum Working Pressure: 266 PSI (18 BAR)

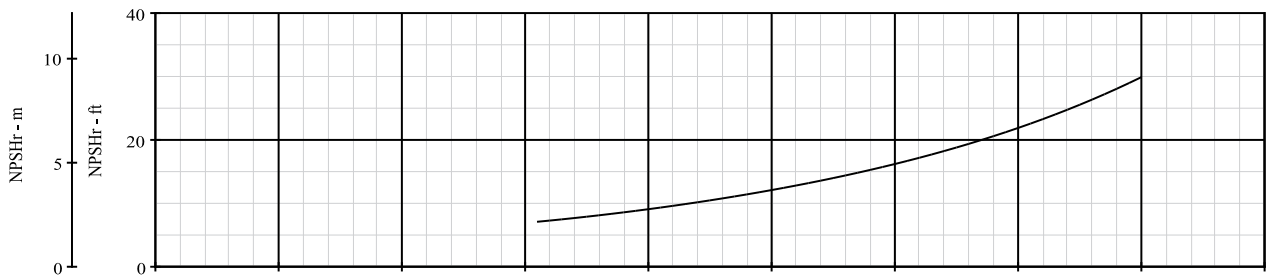
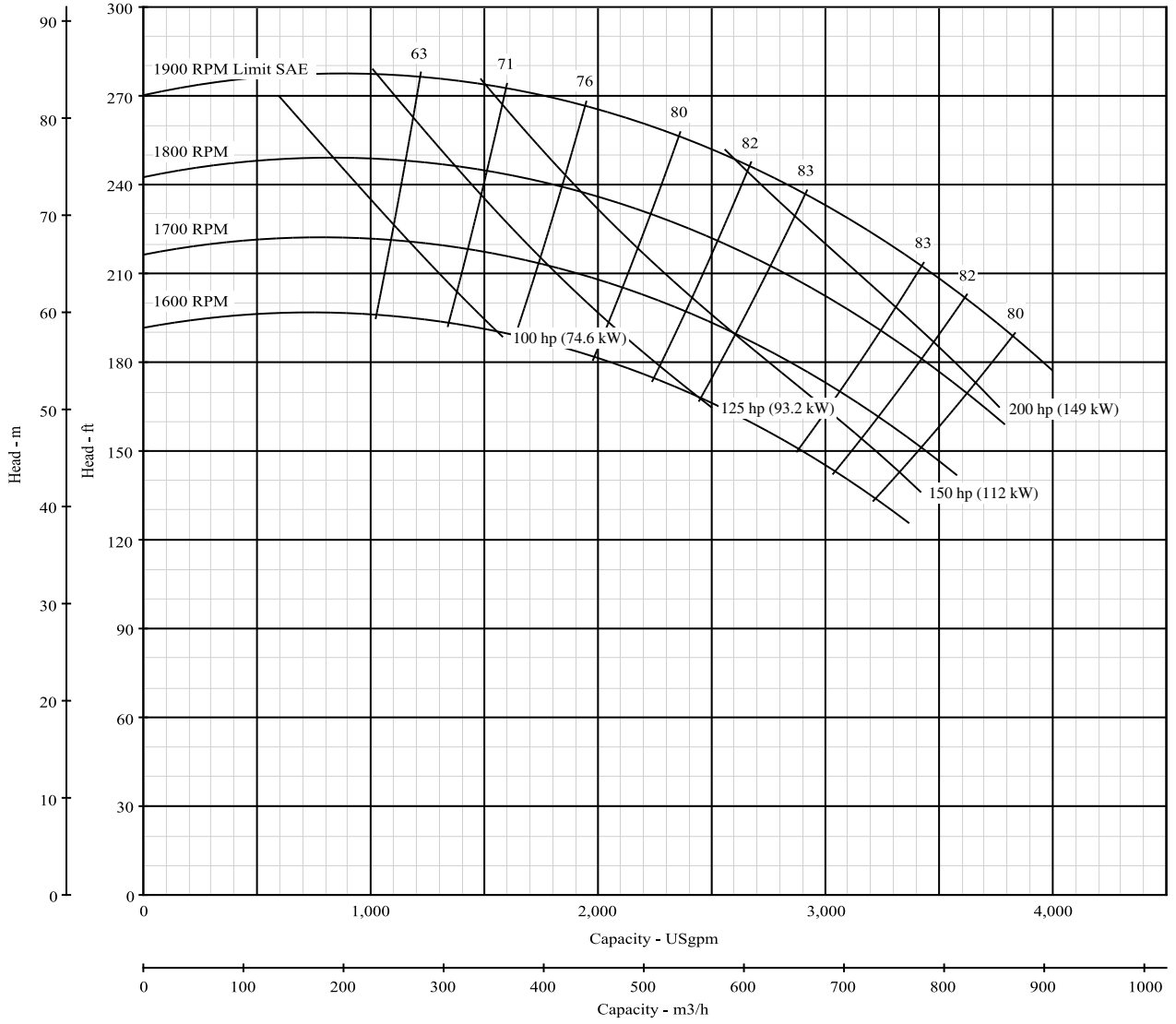

*NPSH data shown is at maximum speed

Pump Size: 6 x 8 x 14 BH

Model: B6XT_BH-14"

Curve No. 3333B

Type	CCMD	FM CPLG	FM BELT	SAE	Hydraulic	AC Engine
Model				B6XTQBH-14"		
RPM				1600-2000		

Dia. 14.00"

Nominal RPM: **VARIOUS**
 Based on Fresh Water @ 68°F (20°C)
 Maximum Working Pressure: 266 PSI (18 BAR)

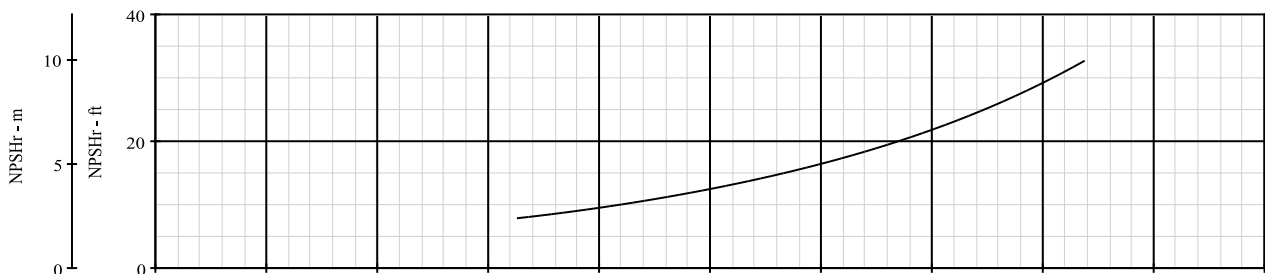
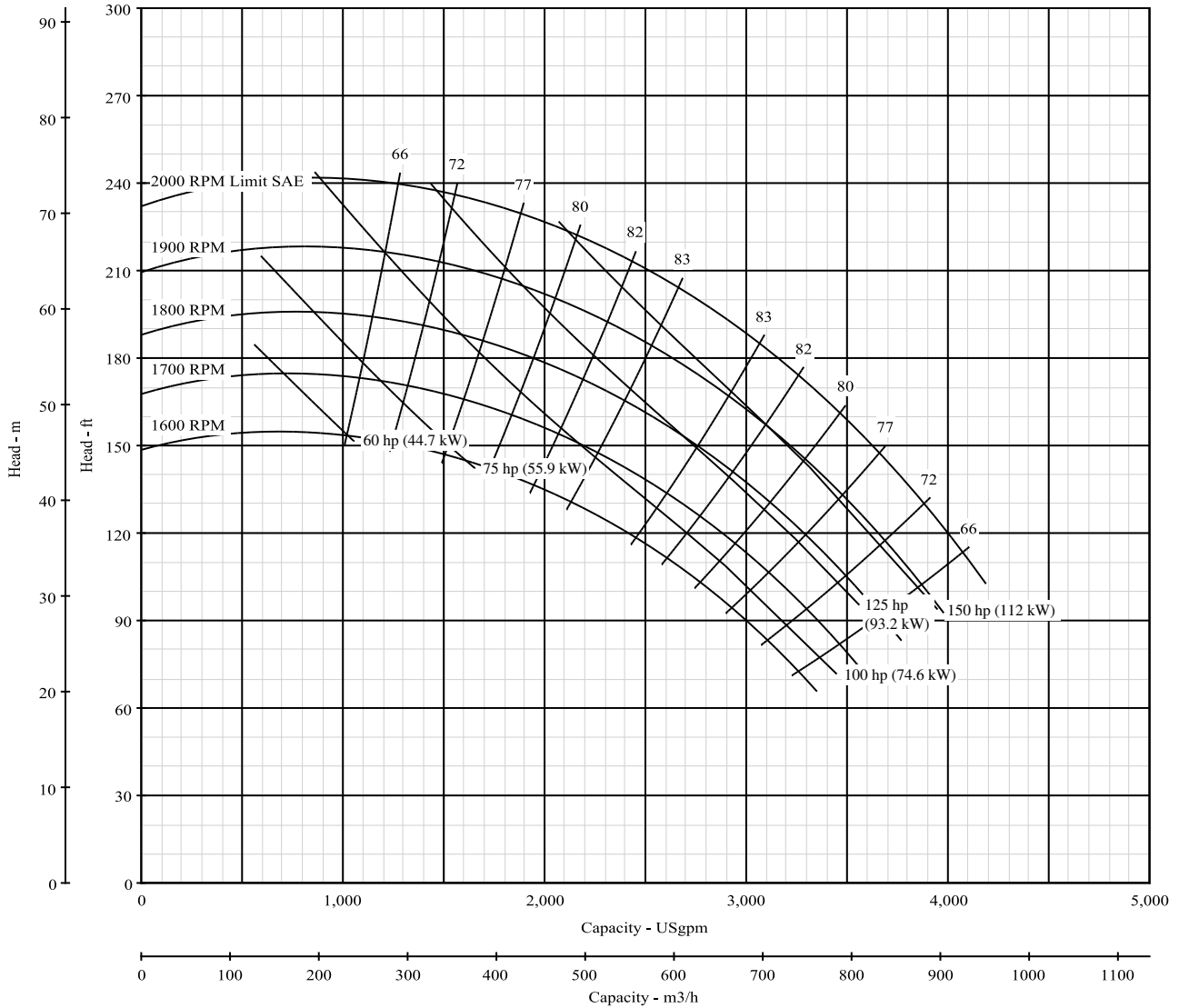

*NPSH data shown is at maximum speed

Pump Size: 4 x 5 x 18 BM

Model: B4EY_BM

Curve No. 6469

Type	CCMD	FM CPLG	FM BELT	SAE	Hydraulic	AC Engine
Model	B4EYPBM	B4EYRMBM	B4EYRMBM	B4EYQBM		

Nominal RPM: **1770**
 Based on Fresh Water @ **68°F (20°C)**
 Maximum Working Pressure: 266 PSI (18 BAR)

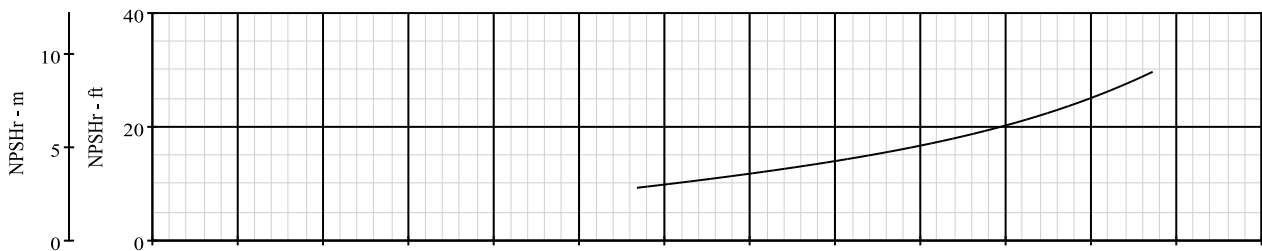
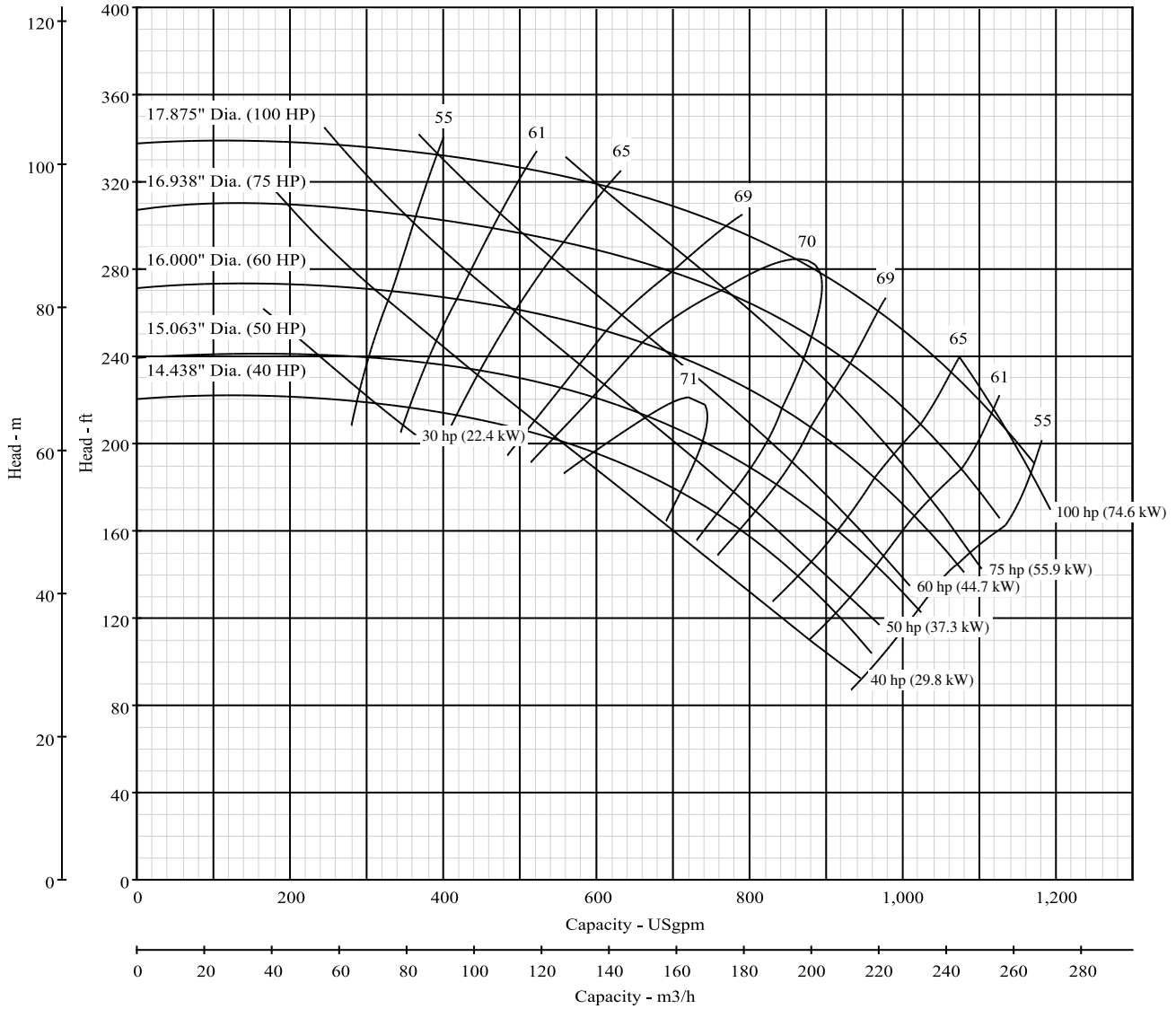

Pump Size: 4 x 5 x 18 BM

Model: B4EY_BM

Curve No. 6469

Type	CCMD	FM CPLG	FM BELT	SAE	Hydraulic	AC Engine
Model	B4EYPBM	B4EYRMBM	B4EYRMBM	B4EYQBM		
RPM	1201-1800	1400-2100	1400-1800	1400-2100		

Dia. 17.875"

Nominal RPM: **VARIOUS**
 Based on Fresh Water @ 68 °F (20 °C)
 Maximum Working Pressure: 266 PSI (18 BAR)

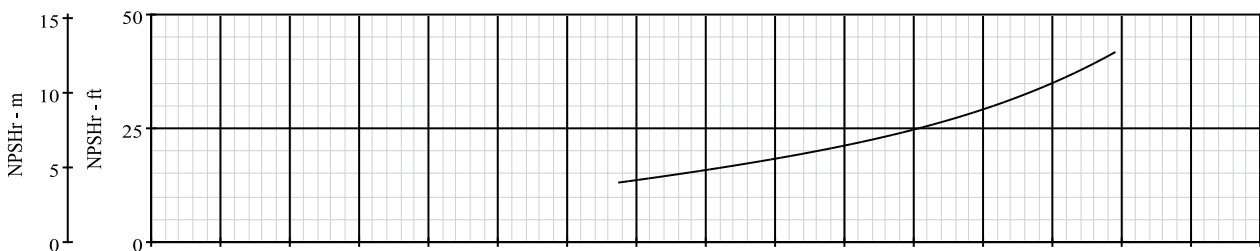
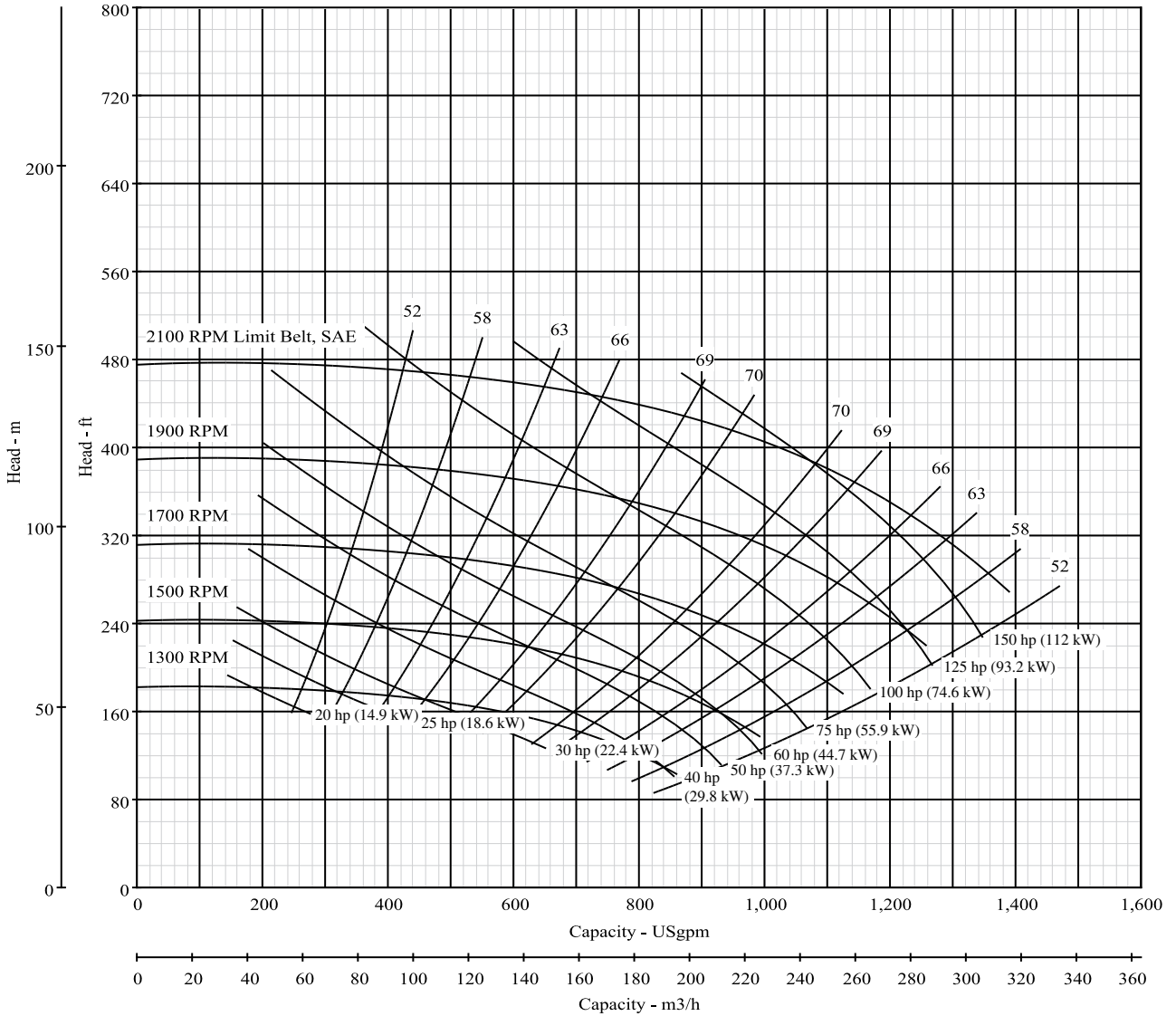

*NPSH data shown is at maximum speed

Pump Size: 4 x 5 x 18 BH

Model: B4EY_BH

Curve No. 5025

Type	CCMD	FM CPLG	FM BELT	SAE	Hydraulic	AC Engine
Model	B4EYPBH	B4EYRMBH		B4EYQBH		

Nominal RPM: **1770**
 Based on Fresh Water @ **68°F (20°C)**
 Maximum Working Pressure: **266 PSI (18 BAR)**

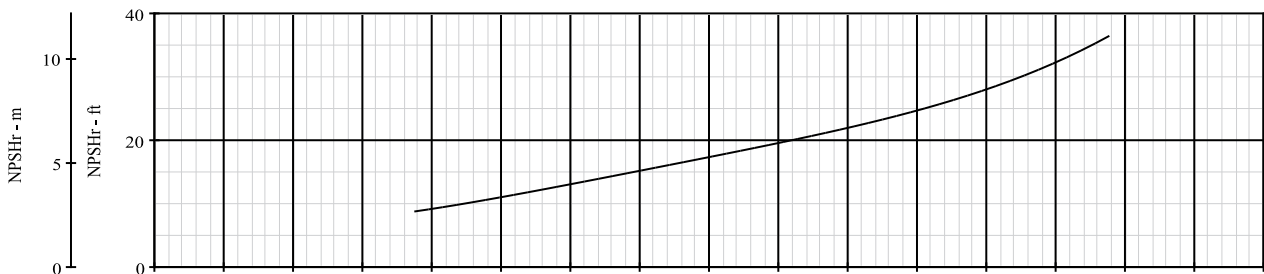
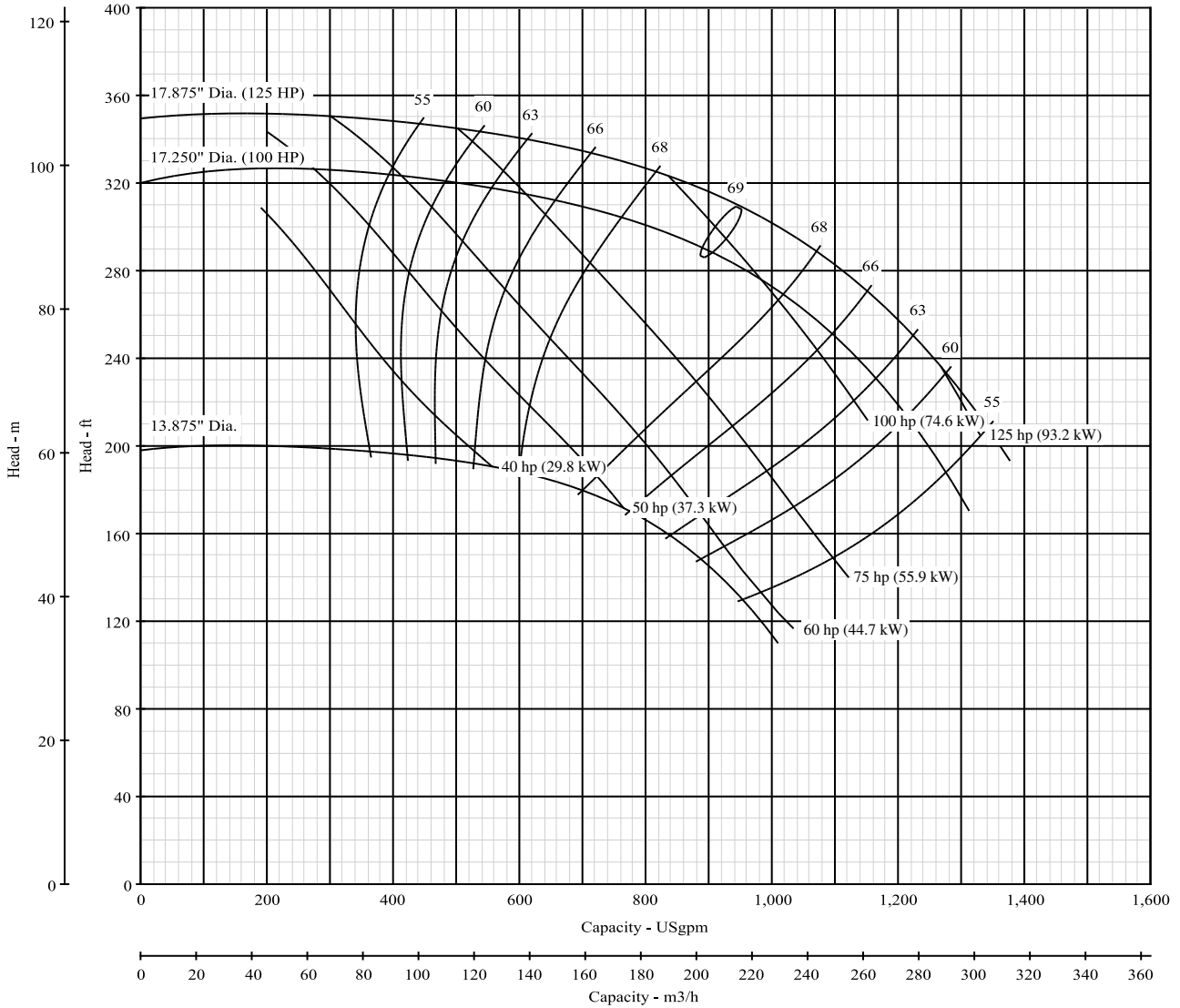

Pump Size: 4 x 5 x 18 BH

Model: B4EY_BH

Curve No. 5025

Type	CCMD	FM CPLG	FM BELT	SAE	Hydraulic	AC Engine
Model	B4EYPBH	B4EYRMBH	B4EYQMBH	B4EYQBH		
RPM	1201-1800	1200-2000	1200-1700	1000-2100		

Dia. 17.875"

Nominal RPM: **VARIOUS**
 Based on Fresh Water @ 68°F (20°C)
 Maximum Working Pressure: 266 PSI (18 BAR)

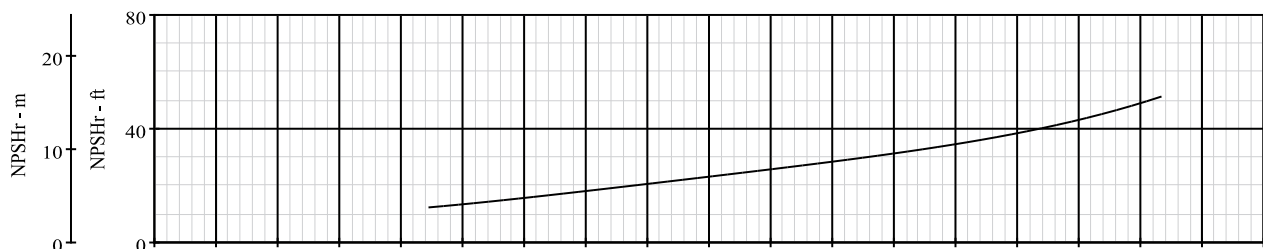
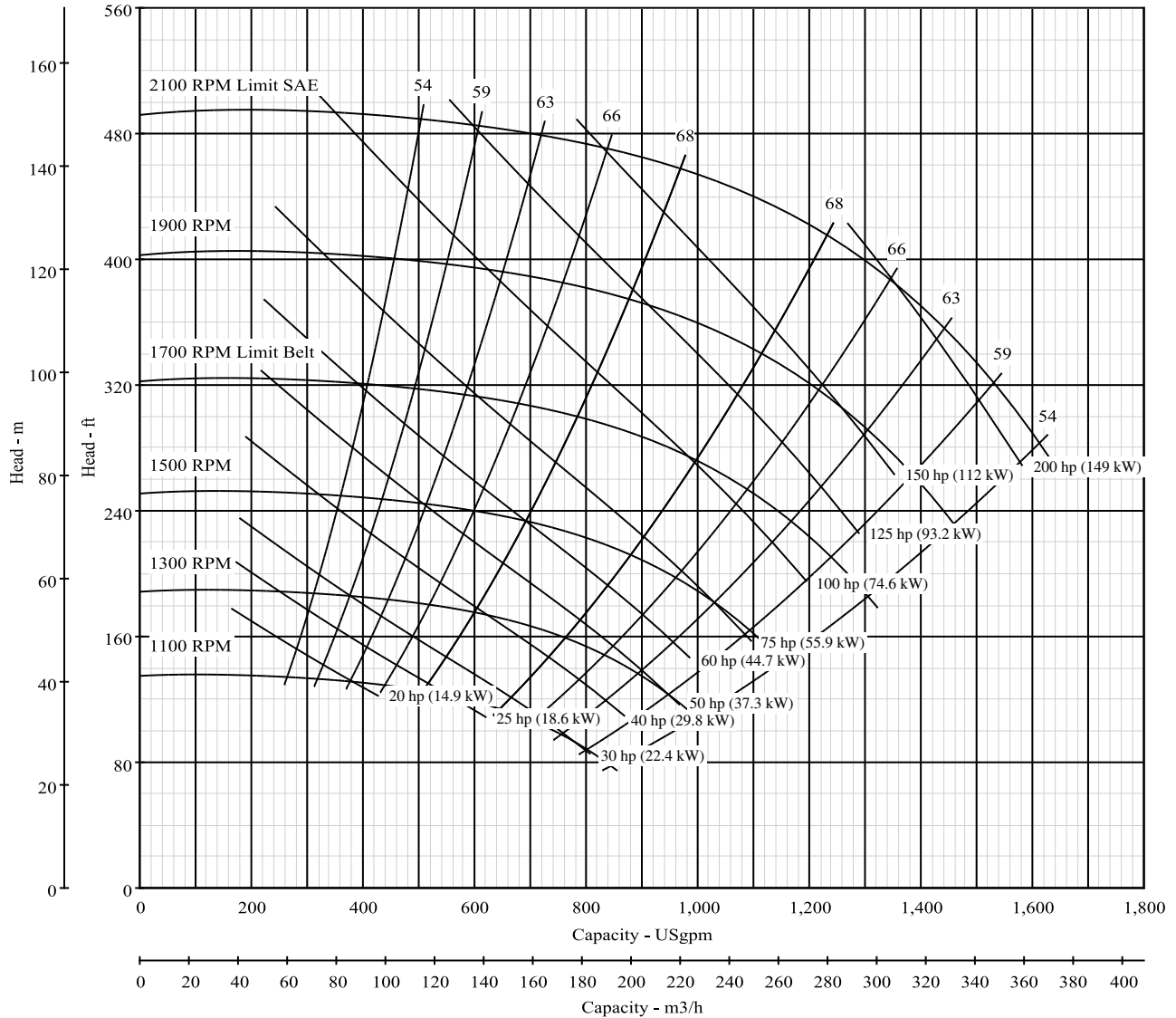

*NPSH data shown is at maximum speed

B SERIES CENTRIFUGAL PUMPS

CURVE NO.	SERIES	MAXIMUM IMPELLER DIAMETER	PUMP SIZE		MODELS						
			DSCHG. x SUCT. x IMPELLER DIA.	MODEL	CCMD (1)	FM CPLG (2)	FM BELT (3)	SAE (4)	HYD (5)		
7327	M	4"	1 x 1-1/4 x 4	B1MRS		B1MRS	B1MRS				
7328			1 x 1-1/4 x 4	B1XRS		B1XRS	B1XRS				
7902			1 x 1-1/4 x 4	B1XRMS		B1XRMS	B1XRMS				
2676	T	6"	1-1/2 x 2 x 4	B1-1/2M_RS		B1-1/2MRS	B1-1/2MRS				
5035			1-1/2x2x6L	B1-1/2T_L	B1-1/2TPL	B1-1/2TRLS	B1-1/2TRLS				
8888			1-1/2x2x6M	B1-1/2T_M	B1-1/2TPM						
8578			2x2-1/2x6M	B2T_M	B2TPM						
5000			2-1/2x3x6M	B2-1/2T_M	B2-1/2TPM	B2-1/2TRMS	B2-1/2TRMS				
5005			3x4x6M	B3T_M	B3TPM	B3TRMS	B3TRMS				
9068			3x4x6H	B3T_H	B3TPH						
9069			3x4x6HH	B3T_HH	B3TPHH						
8233			W	7"	1 x 1-1/2 x 7W	B1W_	B1WP				
3524	5x6x7W	B5W			B5WP						
5036	Z	9"	1-1/2x2x9L	B1-1/2Z_L	B1-1/2ZPL	B1-1/2ZRL	B1-1/2ZRL				
9086			1-1/2x2x9H	B1-1/2Z_HS	B1-1/2ZPHS						
3558			1-1/2x2x9H	B1-1/2Z_HS	B1-1/2ZPHS						
8553			2x2-1/2x9L	B2Z_L	B2ZPL	B2ZRL					
2070			2x2-1/2x9M	B2Z_M		B2ZRM	B2ZRM	B2ZQM			
8940			2x2-1/2x9H	B2Z_H	B2ZPH						
5040			2-1/2x3x9L	B2-1/2Z_L	B2-1/2ZPL	B2-1/2ZRL	B2-1/2ZRL				
5020			2-1/2x3x9M	B2-1/2Z_M	B2-1/2ZPM	B2-1/2ZRM	B2-1/2ZRM	B2-1/2ZQM			
5006			3x4x9L	B3Z_L	B3ZPL						
5021			3x4x9M	B3Z_M	B3ZPM	B3ZRM	B3ZRM	B3ZQM	B3ZRM-HYD		
8512			3x4x9BH	B3Z_BH	B3ZPBH						
4 x 5 x 9BH			4 x 5 x 9BH	B4Z_H	B4ZPBH	B4ZRBH	B4ZRBH	B4ZQBH			
5 x 6 x 9BH			5 x 6 x 9BH	B5Z_H	B5ZPBH	B5ZRBH	B5ZRBH	B5ZQBH			
5838			6x8x9L	B6Z_L	B6ZPL	B6ZRL	B6ZRL	B6ZQL			
7417			6x8x9M-CCW	B6Z_M-CCW		B6ZRM-CCW	B6ZRM-CCW				
9027			6x8x9H	B6Z_H	B6ZPH	B6ZRH	B6ZRH	B6ZQH			
6 x 8 x 9BHH			6 x 8 x 9BHH	B6Z_BHH	B6ZPBHH	B6ZRBHH	B6ZRBHH	B6ZQBHH			
9089			E	10"	1-1/2x2x10L	B1-1/2E_L	B1-1/2EPL	B1-1/2ERL	B1-1/2ERL	B1-1/2EQL	
6541					2x3x10BL	B2E_BL	B2EPBL				
7625					2x3x10L	B2E_L		B2ERL	B2ERL		
7626					2x3x10H	B2E_H		B2ERH	B2ERH		
6657	2x3x10BH	B2E_BH				B2ERBH	B2ERBH				
8671	2x3x10BHH	B2E_BHH			B2EPBHH						
8648	2x3x10HH	B2E_HH				B2ERHH	B2ERHH	B2EQHH			
8904	3x4x10BL	B3E_BL			B3EPBL	B3ERBL	B3ERBL	B3EQBL			
6545	3x4x10M	B3E_M			B3EPM	B3ERM	B3ERM				
8989	4x5x10BM	B4E_BM			B4EPBM	B4ERBM					
6425	4x5x10M	B4E_M			B4EPM	B4ERM	B4ERM	B4EQM			
8726	5x6x10BM	B5E_BM			B5EPBM						
7801	5x6x10H	B5E_H			B5EPH	B5ERH	B5ERH				
7801A	5x6x10BH	B5E_BH						B5EQBH			
1234	4x5x12BH	B4G_BH			B4GPBH	B4GRMBH	B4GRMBH	B4GQBH			
5033	8x10x12BM	B8G_BM			B8GPBM	B8GRMBM	B8GRMBM	B8GQBM			
7632	10x12x12BM	B10G_BM - 4 pole			B10GPBM	B10GRMBM		B10GQBM			
7512	10x12x12BM	B10G_BM - 6 pole			B10GPBM	B10GRMBM	B10BRMBM	B10GQBM			
7045	2-1/2x4x13BL	B2-1/2J_BL						B2-1/2JQBL			
6266	J	13.5"			2-1/2x4x13BM	B2-1/2J_BM	B2-1/2JPBM	B2-1/2JRBMBM	B2-1/2JRBMBM	B2-1/2JQBM	B2-1/2JRBMBM
5845					3x4x13BL	B3J_BL	B3JPBL				
5846			3x4x13BM	B3J_BM	B3JPBM	B3JRMBM	B3JRMBM	B3JQBM	B3JRMBM		
9013			4x5x13BH	B4J_BH	B4JPBH	B4JRMBH	B4JRMBH	B4JQBH	B4JRMBH		
9017			4x6x13BHH	B4J_BHH	B4JPBHH	B4JRBHH	B4JRBHH				
5026			6x8x13BL	B6J_BL	B6JPBL	B6JRMBL	B6JRMBL	B6JQBL			
8851			6x8x13BM	B6J_BM	B6JPBM	B6JRMBM-CCW	B6JRMBM-CCW				
8851A			6x8x13BM-CW	B6J_BM-CW		B6JRMBM-CW	B6JRMBM-CW	B6JQBM-CW			
8934			6x8x13BH	B6J_BH	B6JPBH	B6JRMBH					
8x10x13 BH			8x10x13 BH	B8J_BH	B8JPBH	B8JRMBH	B8JRMBH	B8JQBH			
10x12x13 BH			10x12x13 BH	B10J_BH	B10JPBH	B10JRMBH	B10JRMBH	B10JQBH			
9112			4x5x15BL	B4EX_BL	B4EXPBL			B4EXQBL			
8443			5x6x15BH	B5EX_BH	B5EXPBH			B5EXQBHS			
7452			6x8x15BL	B6EX_BL	B6EXPBL	B6EXRBL	B6EXRBL				
8856			6x8x15BM	B6EX_BM				B6EXQBM			
8845	6x8x15BH	B6EX_BH	B6EXPBH	B6EXRBH	B6EXRBH						
3333A	6x8x15.5BH	B6XT_BH-15.5"				B6XTQBH-15.5"					
3333B	6x8x14BH	B6XT_BH-14"				B6XTQBH-14"					
6469	EY	18"	4x5x18BM	B4EY_BM	B4EYPBM	B4EYRMBM	B4EYRMBM	B4EYQBM			
5025			4x5x18BH	B4EY_BH	B4EYPBH	B4EYMBH	B4EYMBH	B4EYQBH			

FIXED SPEED			VARIABLE SPEED				
3600 RPM	1800 RPM	1200 RPM	CCMD	FM CPLG	FM BELT	SAE	HYD
X				2800-4900	2800-4900		
X			1801-3600	1800-3500	1800-3500		
X			1801-3600				
X			1801-3600	1800-3000	1800-3000		
X	X		1201-3600	1400-2800	1400-2800		
X	X		1201-3600	1400-2400	1400-2400		
X	X		1201-3600				
X			1801-3600				
X			1801-3600				
	X		1201-1800				
X			1801-3600	1000-3600	1000-3600		
X	X		1201-3600				
			1201-3600				
X			1801-3600	1000-3600			
	X			1000-2800	1000-2800	1800-3200	
X			1801-3600				
X	X		1801-3600	1400-3400	1400-2700		
	X		1201-1800	1400-3400	1400-2700	1800-2600	
X			1201-3600				
	X		1201-1800	1400-2500	1400-2300	1600-2500	1400-2500
X			1801-3600				
	X		1201-1800	1600-2800	1600-2500	1600-2800	
	X		1201-1800	1600-2500	1600-2200	1600-2500	
	X		1201-1800	1400-2300	1400-2100	1200-1800	
	X			1600-2200	1600-2200		
	X		1201-1800	1200-2000	1200-1900	1200-1800	
	X		1201-1800	1600-2000	1600-2000	1600-2000	
X			1801-3600	1800-3000	1800-2800	2000-3200	
X							
	X			1800-3400	1800-2900		
	X			1600-2800	1600-2400		
				1400-3200	1400-3200		
X			1801-3600				
	X			1400-2800	1400-2600	1600-3200	
X			1801-3600	1400-3500	1400-3500	1800-3500	
	X		1201-1800	1400-2200	1400-2000		
X			1801-3600	1400-3600	1400-2800		
	X		1201-1800	1400-2000	1400-1800	1800-3100	
X			1801-3600				
	X		1201-1800	1400-2000	1400-1800		
						1600-2900	
	X		1201-1800	1400-2400	1400-2200	1600-2400	
	X	X	901-1800	1200-2200	1200-1700	1000-2100	
	X						
		X	901-1200	1000-1800	1000-1700	900-1900	
						1600-2800	
	X		1201-1800	1400-2700	1400-2700	1600-2800	1400-2800
	X		1201-1800				
	X		1201-1800	1400-2700	1400-2700	1600-3000	1400-2700
	X		1201-1800	1400-2400	1400-2200	1400-2400	1400-2400
	X		1201-1800	1400-2400	1400-2200		
	X		1201-1800	1200-2200	1200-2100	1600-2200	
	X		901-1800	1200-2100	1200-1800		
	X			1200-2100	1200-1800	1400-2200	
	X		1201-1800	1400-2000	1400-1700		
	X		1201-1800	1400-2300	1400-2300	1400-2300	
	X		1201-1800	1300-2100	1300-2100	1300-2100	
	X		1201-1800			1600-2200	
	X		1201-1800			1600-2300	
	X		1201-1800	1200-2000	1200-1800		
						1600-2000	
	X		1201-1800	1400-1900	1400-1700		
						1600-1900	
	X					1600-2000	
	X		1201-1800	1400-2100	1400-1800	1400-2100	
	X		1201-1800	1200-2000	1400-1700	1000-2100	



293 WRIGHT STREET, DELAVAN, WI 53115 WWW.BERKELEYPUMPS.COM
PH: 888-237-5353 ORDERS FAX: 800-321-8793

Because we are continuously improving our products and services, Pentair reserves the right to change specifications without prior notice.