

FL104M-2 (B72)

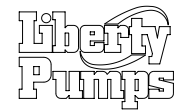
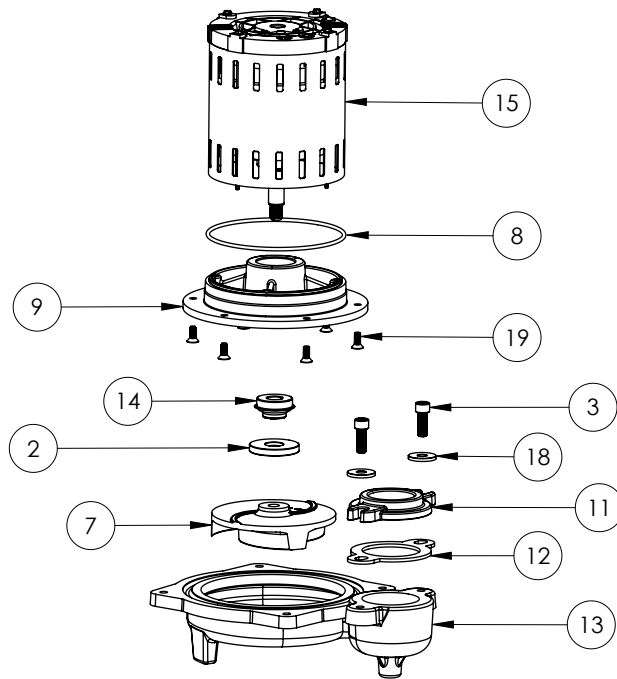
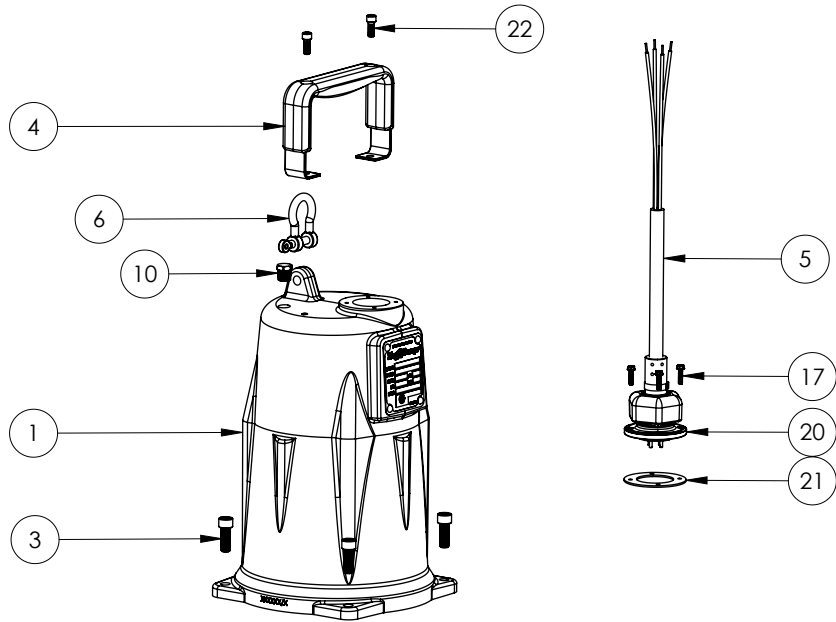

FL104M-2**FL104M-2 (B72)**

#	PART #	DESCRIPTION	QTY	Note
1	585000R	MOTOR COVER PAINTED	1	
2	5860000	LIP SEAL, 0.625 x 2	1	
3	5862000	BOLT, 3/8-16X1 SHCS SS	6	
4	5613000	HANDLE	1	
5	K001357	POWER CORD, 25FT	1	
6	5611000	SHACKLE	1	
7	K001439	KIT, FL100 IMPELLER 3 BLADE	1	
8	5617000	O-RING	1	
9	58510B0	MOTOR PLATE	1	[1]
10	50710A0	PIPE PLUG, 1/4" HEX HD BRASS NPTF	1	
11	K001421	1.5" DISCHARGE ADAPTER, INCLUDES HARDWARE AND GASKET	1	
12	5858000	1.5" FLANGE GASKET	1	
13	585400R	VOLUTE	1	
14	5120000	5/8 INCH UNITIZED SHAFT SEAL	1	[1]
15	5364000	MOTOR	1	
17	8064000	#8-32 x 5/8 HEX WASHER HEAD SCREW	4	
18	8158000	WASHER, 3/8 x 1-1/8, SS	2	
19	8018000	1/4-20 x 5/8 SLOTTED FLAT HEAD BOLT	6	
20	K001216	5619000, CORDPLATE	1	
21	5060000	CORD PLATE GASKET	1	
22	8103000	SCREW 1/4-20x5/8" HX SKT SS	2	

PART NOTES:

[1] - Part requires factory authorized service. Contact Liberty Pumps at 1-800-543-2550