

<b>JOB:</b>  <b>UNIT TAG:</b> <b>ENGINEER:</b> <b>CONTRACTOR:</b>	<b>REPRESENTATIVE:</b>  <b>ORDER NO.:</b> <b>SUBMITTED BY:</b> <b>APPROVED BY:</b>	<b>DATE:</b> <b>DATE:</b> <b>DATE:</b>
---	--	--

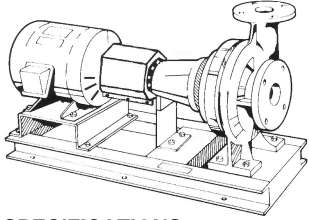

# 4EB

## Series e-1510

### Centrifugal Pumps - Base Mounted

**SPECIFICATIONS**

FLOW \_\_\_\_\_ HEAD \_\_\_\_\_

HP \_\_\_\_\_ RPM \_\_\_\_\_

VOLTS \_\_\_\_\_

CYCLE \_\_\_\_\_ PHASE \_\_\_\_\_

ENCLOSURE \_\_\_\_\_

APPROX. WEIGHT \_\_\_\_\_

SPECIALS \_\_\_\_\_

**Note: Equipped with NEOPRENE coupling**

**MATERIALS OF CONSTRUCTION**

STAINLESS STEEL FITTED

**FEATURES**

- i-ALERT™ Condition Monitor
- ANSI/OSHA Coupling Guard
- Center Drop Out Spacer Coupling
- Fabricated Heavy Duty Baseplate

**MAXIMUM WORKING PRESSURE**

- 175 psi (12 bar) W.P. w/125# ANSI flange drilling
- 250 psi (17 bar) W.P. w/250# ANSI flange drilling (requires 1510-S)

**TYPE OF SEAL**

- Standard Seal (Buna-Carbon/Ceramic)
- F Standard Seal w/ Flush Line (Buna-Carbon/Ceramic)
- S Stuffing Box Construction w/ Flushed Mechanical Single Seal (EPR-Tungsten Carbide/Carbon)
- PF Stuffing Box Construction w/ Packing (Graphite Impregnated Teflon)

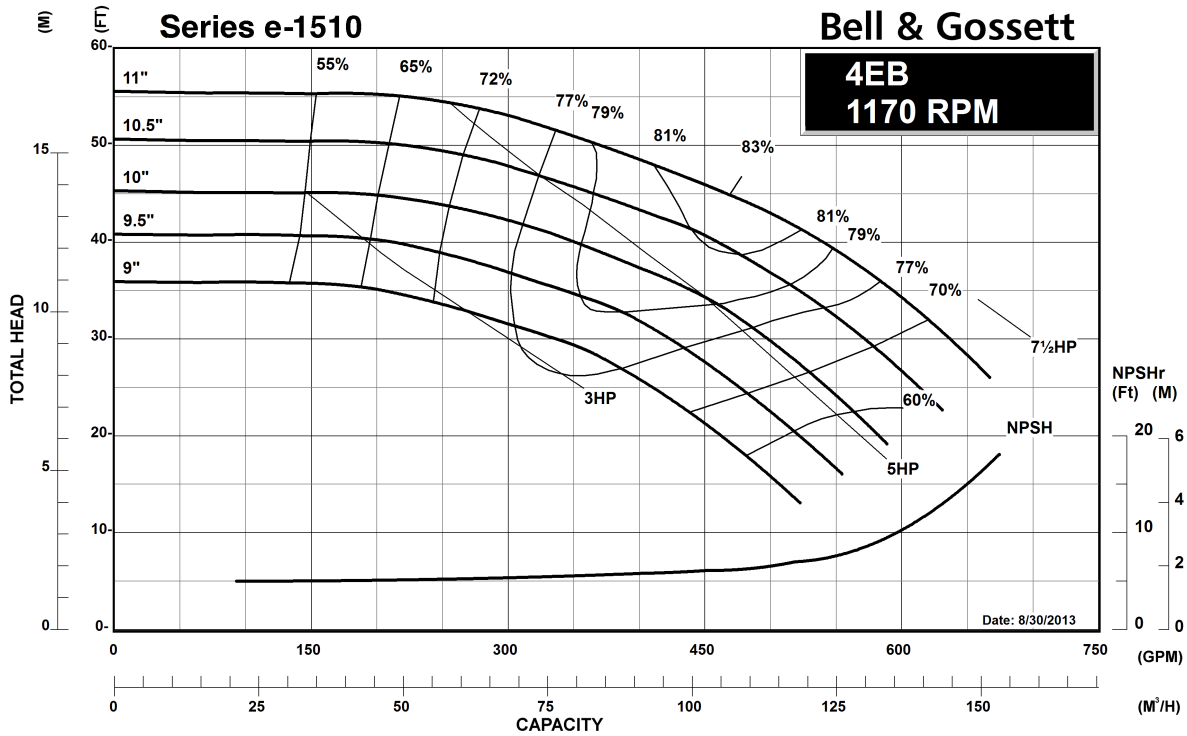

<b>JOB:</b>   <b>UNIT TAG:</b> <b>ENGINEER:</b> <b>CONTRACTOR:</b>	<b>REPRESENTATIVE:</b>   <b>ORDER NO.:</b> <b>SUBMITTED BY:</b> <b>APPROVED BY:</b>	<b>DATE:</b> <b>DATE:</b> <b>DATE:</b>
---	--	--

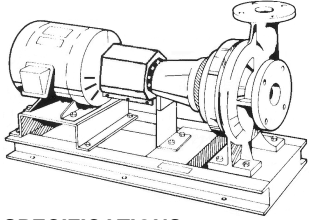

# 4EB

## Series e-1510

### Centrifugal Pumps - Base Mounted

**SPECIFICATIONS**

FLOW \_\_\_\_\_ HEAD \_\_\_\_\_

HP \_\_\_\_\_ RPM \_\_\_\_\_

VOLTS \_\_\_\_\_

CYCLE \_\_\_\_\_ PHASE \_\_\_\_\_

ENCLOSURE \_\_\_\_\_

APPROX. WEIGHT \_\_\_\_\_

SPECIALS \_\_\_\_\_

**MATERIALS OF CONSTRUCTION**

STAINLESS STEEL FITTED

**FEATURES**

- i-ALERT™ Condition Monitor
- ANSI/OSHA Coupling Guard
- Center Drop Out Spacer Coupling
- Fabricated Heavy Duty Baseplate

**MAXIMUM WORKING PRESSURE**

- 175 psi (12 bar) W.P. w/125# ANSI flange drilling
- 250 psi (17 bar) W.P. w/250# ANSI flange drilling (requires 1510-S)

**TYPE OF SEAL**

- Standard Seal (Buna-Carbon/Ceramic)
- F Standard Seal w/ Flush Line (Buna-Carbon/Ceramic)
- S Stuffing Box Construction w/ Flushed Mechanical Single Seal (EPR-Tungsten Carbide/Carbon)
- PF Stuffing Box Construction w/ Packing (Graphite Impregnated Teflon)

**Note: Equipped with NEOPRENE coupling**

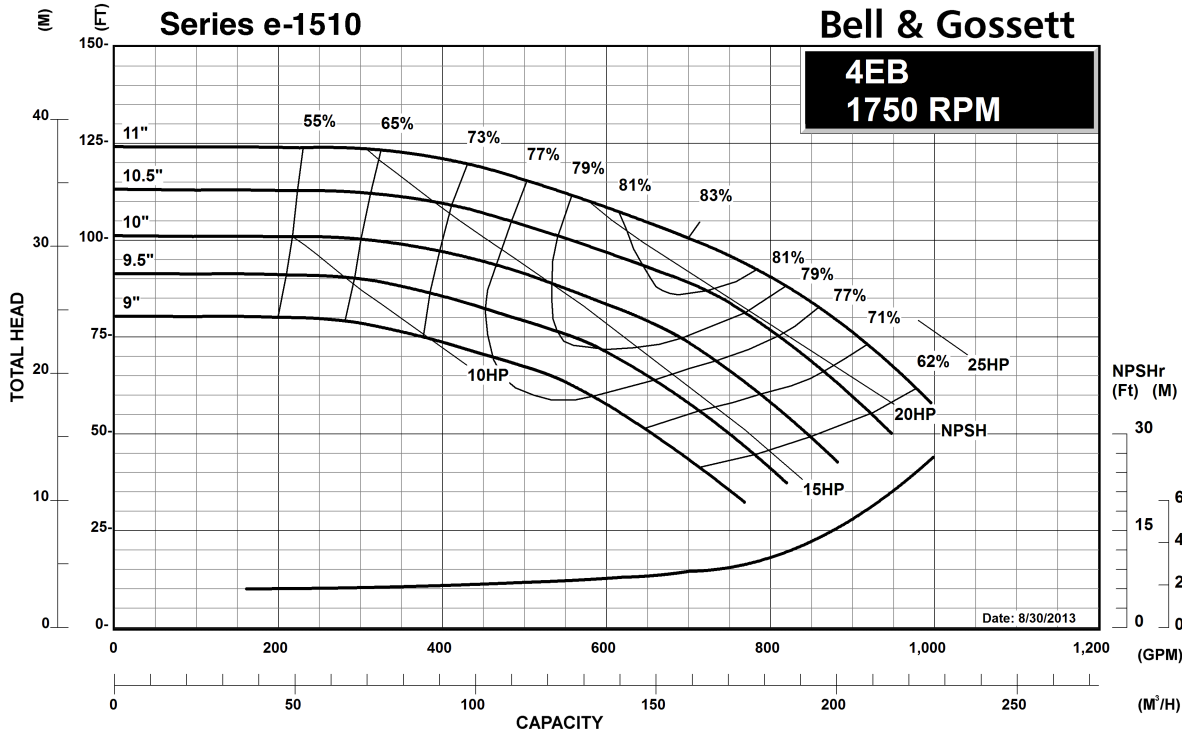

<b>JOB:</b>   <b>UNIT TAG:</b> <b>ENGINEER:</b> <b>CONTRACTOR:</b>	<b>REPRESENTATIVE:</b>   <b>ORDER NO.:</b> <b>SUBMITTED BY:</b> <b>APPROVED BY:</b>	<b>DATE:</b> <b>DATE:</b> <b>DATE:</b>
---	--	--

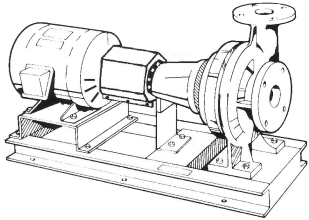

# 4EB

## Series e-1510

### Centrifugal Pumps - Base Mounted

**SPECIFICATIONS**

FLOW \_\_\_\_\_ HEAD \_\_\_\_\_

HP \_\_\_\_\_ RPM \_\_\_\_\_

VOLTS \_\_\_\_\_

CYCLE \_\_\_\_\_ PHASE \_\_\_\_\_

ENCLOSURE \_\_\_\_\_

APPROX. WEIGHT \_\_\_\_\_

SPECIALS \_\_\_\_\_

**Note: Equipped with NEOPRENE coupling**

**MATERIALS OF CONSTRUCTION**

STAINLESS STEEL FITTED

**FEATURES**

- i-ALERT™ Condition Monitor
- ANSI/OSHA Coupling Guard
- Center Drop Out Spacer Coupling
- Fabricated Heavy Duty Baseplate

**MAXIMUM WORKING PRESSURE**

- 175 psi (12 bar) W.P. w/125# ANSI flange drilling
- 250 psi (17 bar) W.P. w/250# ANSI flange drilling (requires 1510-S)

**TYPE OF SEAL**

- Standard Seal (Buna-Carbon/Ceramic)
- F Standard Seal w/ Flush Line (Buna-Carbon/Ceramic)
- S Stuffing Box Construction w/ Flushed Mechanical Single Seal (EPR-Tungsten Carbide/Carbon)
- PF Stuffing Box Construction w/ Packing (Graphite Impregnated Teflon)

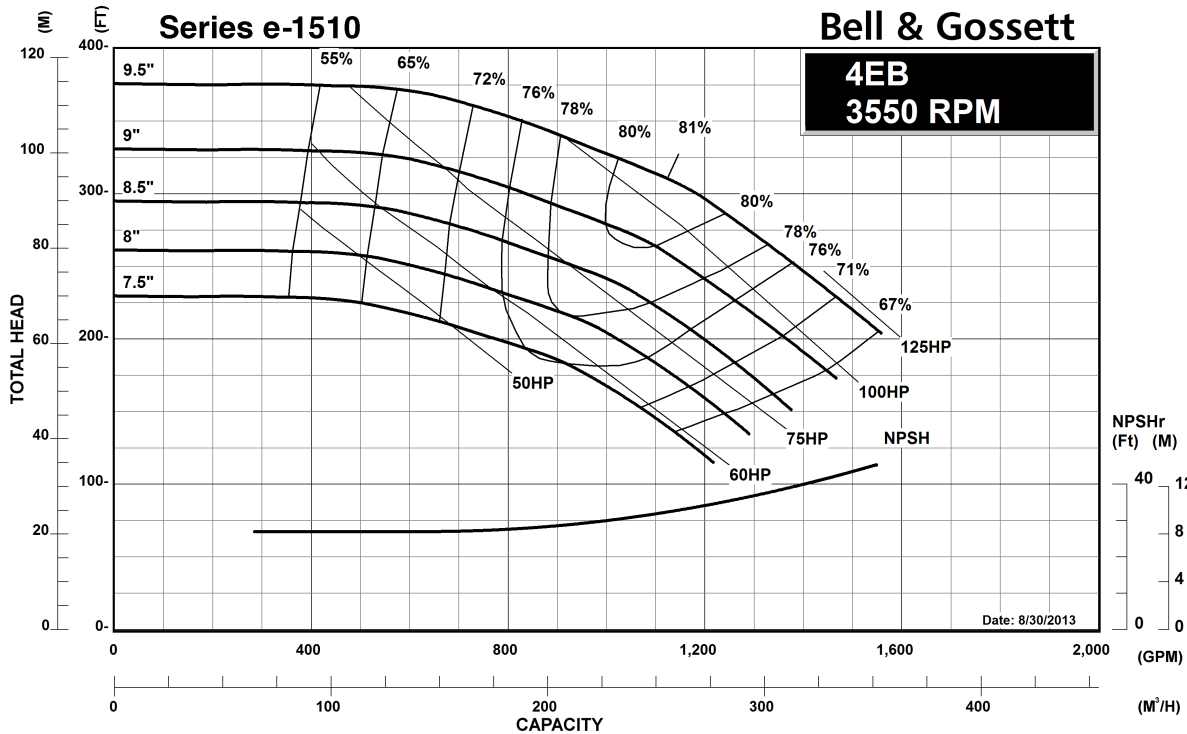

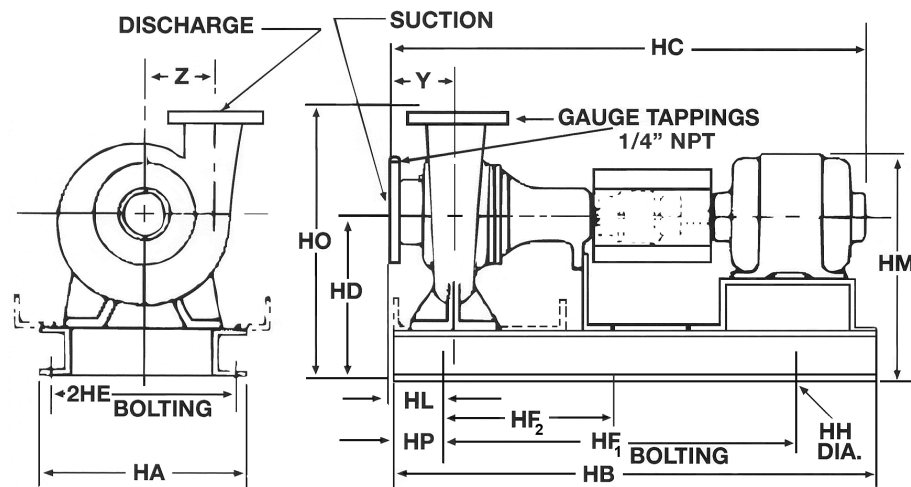

FLANGE DIMENSIONS IN INCHES (MM)			
	SIZE	THICKNESS	O.D.
Discharge	4" (102)	1-1/4" (32)	9-1/2" (241)
Suction	5" (127)	1-3/8" (35)	10-3/4" (273)

FLANGES ARE 125# ANSI - STANDARD  
250# ANSI - AVAILABLE

DIMENSIONS - Inches (mm)

MOTOR FRAME	STANDARD SEAL													
	HA	HB	HC MAX	HD	2HE	HF <sub>1</sub>	HF <sub>2</sub>	HH	HL	HM MAX	HO	HP	Y	Z
<b>"S" FRAME</b>														
213T	16 (406)	42-1/4 (1073)	37-1/2 (952)	14 (356)	14 (356)	32-1/4 (819)	16-1/8 (410)	7/8 (22)	6-11/16 (170)	19-7/8 (505)	23-3/4 (603)	5 (127)	5-9/16 (141)	7-1/4 (184)
215T	16 (406)	42-1/4 (1073)	39 (991)	14 (356)	14 (356)	32-1/4 (819)	16-1/8 (410)	7/8 (22)	6-11/16 (170)	19-7/8 (505)	23-3/4 (603)	5 (127)	5-9/16 (141)	7-1/4 (184)
254T	16 (406)	42-1/4 (1073)	42-3/4 (1086)	14 (356)	14 (356)	32-1/4 (819)	16-1/8 (410)	7/8 (22)	6-11/16 (170)	20-7/8 (530)	23-3/4 (603)	5 (127)	5-9/16 (141)	7-1/4 (184)
<b>"L" FRAME</b>														
256T	16 (406)	46-1/2 (1181)	48-3/8 (1229)	14 (356)	14 (356)	36-1/2 (927)	18-1/4 (464)	7/8 (22)	4-5/16 (110)	20-7/8 (530)	23-3/4 (603)	5 (127)	5-9/16 (141)	7-1/4 (184)
284T	16 (406)	51-3/4 (1314)	49-1/8 (1248)	14 (356)	14 (356)	41-3/4 (1060)	20-7/8 (530)	7/8 (22)	4-5/16 (110)	22 (559)	23-3/4 (603)	5 (127)	5-9/16 (141)	7-1/4 (184)
286TS	16 (406)	51-3/4 (1314)	50-5/8 (1286)	14 (356)	14 (356)	41-3/4 (1060)	20-7/8 (530)	7/8 (22)	4-5/16 (110)	22 (559)	23-3/4 (603)	5 (127)	5-9/16 (141)	7-1/4 (184)
324TS	16 (406)	51-3/4 (1314)	51-1/8 (1299)	14 (356)	14 (356)	41-3/4 (1060)	20-7/8 (530)	7/8 (22)	4-5/16 (110)	23-1/8 (587)	23-3/4 (603)	5 (127)	5-9/16 (141)	7-1/4 (184)
326TS	16 (406)	51-3/4 (1314)	52-5/8 (1337)	14 (356)	14 (356)	41-3/4 (1060)	20-7/8 (530)	7/8 (22)	4-5/16 (123)	23-1/8 (587)	23-3/4 (603)	5 (127)	5-9/16 (141)	7-1/4 (184)
364TS	24 (610)	56 (1422)	54-3/8 (1381)	16-1/2 (419)	21-1/2 (546)	44 (1118)	22 (559)	1 (25)	4-15/16 (125)	26-3/4 (679)	26-1/4 (667)	6 (152)	5-9/16 (141)	7-1/4 (184)
365TS	24 (610)	56 (1422)	55-1/8 (1400)	16-1/2 (419)	21-1/2 (546)	44 (1118)	22 (559)	1 (25)	4-15/16 (125)	26-3/4 (679)	26-1/4 (667)	6 (152)	5-9/16 (141)	7-1/4 (184)
404TS	24 (610)	56 (1422)	57-3/8 (1457)	16-1/2 (419)	21-1/2 (546)	44 (1118)	22 (559)	1 (25)	4-15/16 (125)	28-3/8 (721)	26-1/4 (667)	6 (152)	5-9/16 (141)	7-1/4 (184)

MOTOR FRAME	STUFFING BOX													
	HA	HB	HC MAX	HD	2HE	HF <sub>1</sub>	HF <sub>2</sub>	HH	HL	HM MAX	HO	HP	Y	Z
<b>"S" FRAME</b>														
213T	16 (406)	42-1/4 (1073)	41-1/8 (1044)	14 (356)	14 (356)	32-1/4 (819)	16-1/8 (409)	7/8 (22)	6-11/16 (170)	19-7/8 (505)	23-3/4 (603)	5 (127)	5-9/16 (141)	7-1/4 (184)
215T	16 (406)	42-1/4 (1073)	42-5/8 (1083)	14 (356)	14 (356)	32-1/4 (819)	16-1/8 (409)	7/8 (22)	6-11/16 (170)	19-7/8 (505)	23-3/4 (603)	5 (127)	5-9/16 (141)	7-1/4 (184)
254T	16 (406)	42-1/4 (1073)	46-3/8 (1178)	14 (356)	14 (356)	32-1/4 (819)	16-1/8 (409)	7/8 (22)	6-11/16 (170)	20-7/8 (530)	23-3/4 (603)	5 (127)	5-9/16 (141)	7-1/4 (184)
<b>"L" FRAME</b>														
256T	16 (406)	51-3/4 (1314)	50-7/8 (1292)	14 (356)	14 (356)	41-3/4 (1060)	20-7/8 (530)	7/8 (22)	4-5/16 (110)	20-7/8 (530)	23-3/4 (603)	5 (127)	5-9/16 (141)	7-1/4 (184)
284T	16 (406)	51-3/4 (1314)	51-1/2 (1308)	14 (356)	14 (356)	41-3/4 (1060)	20-7/8 (530)	7/8 (22)	4-5/16 (110)	22 (559)	23-3/4 (603)	5 (127)	5-9/16 (141)	7-1/4 (184)
286TS	16 (406)	51-3/4 (1314)	53 (1346)	14 (356)	14 (356)	41-3/4 (1060)	20-7/8 (530)	7/8 (22)	4-5/16 (110)	22 (559)	23-3/4 (603)	5 (127)	5-9/16 (141)	7-1/4 (184)
324TS	16 (406)	51-3/4 (1314)	53-1/2 (1359)	14 (356)	14 (356)	41-3/4 (1060)	20-7/8 (530)	7/8 (22)	4-5/16 (110)	23-1/8 (587)	23-3/4 (603)	5 (127)	5-9/16 (141)	7-1/4 (184)
326TS	16 (406)	51-3/4 (1314)	55-1/8 (1400)	14 (356)	14 (356)	41-3/4 (1060)	20-7/8 (530)	7/8 (22)	4-5/16 (110)	23-1/8 (587)	23-3/4 (603)	5 (127)	5-9/16 (141)	7-1/4 (184)
364TS	24 (610)	56 (1422)	56-7/8 (1444)	16-1/2 (419)	21-1/2 (546)	44 (1118)	22 (559)	1 (25)	4-15/16 (125)	26-3/4 (679)	26-1/4 (667)	6 (152)	5-9/16 (141)	7-1/4 (184)
365TS	24 (610)	56 (1422)	57-1/2 (1460)	16-1/2 (419)	21-1/2 (546)	44 (1118)	22 (559)	1 (25)	4-15/16 (125)	26-3/4 (679)	26-1/4 (667)	6 (152)	5-9/16 (141)	7-1/4 (184)
404TS	24 (610)	56 (1422)	59-3/4 (1518)	16-1/2 (419)	21-1/2 (546)	44 (1118)	22 (559)	1 (25)	4-15/16 (125)	28-3/8 (721)	26-1/4 (667)	6 (152)	5-9/16 (141)	7-1/4 (184)

Dimensions are subject to change. Not to be used for construction purposes unless certified.

Xylem Inc.  
8200 N. Austin Avenue  
Morton Grove, IL 60053  
Phone: (847)966-3700  
Fax: (847)965-8379  
www.xyleminc.com/brands/bellgossett

