

JOB: UNIT TAG: ENGINEER: CONTRACTOR:	REPRESENTATIVE: ORDER NO. SUBMITTED BY: APPROVED BY:	DATE: DATE: DATE:
---	---	--

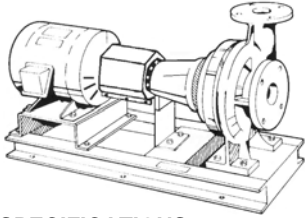

2BD Series e-1510 Centrifugal Pumps - Base Mounted

SPECIFICATIONS

FLOW _____ HEAD _____
 HP _____ RPM _____
 VOLTS _____
 CYCLE _____ PHASE _____
 ENCLOSURE _____
 APPROX. WEIGHT _____
 SPECIALS _____

MATERIALS OF CONSTRUCTION

Stainless Steel Fitted

FEATURES

- i-ALERT™ Condition Monitor
- ANSI/OSHA Coupling Guard
- Center Drop Out Spacer Coupling
- Fabricated Heavy Duty Baseplate

MAXIMUM WORKING PRESSURE

175 psi (12 bar) W.P.
w/ 125# ANSI flange drilling

TYPE OF SEAL

- Standard Seal (Buna-Carbon/Ceramic)
- F Standard Seal w/ Flush Line (Buna-Carbon/Ceramic)
- S Stuffing Box Construction w/ Flushed Mechanical Single Seal (EPR-Tungsten Carbide/Carbon)
- PF Stuffing Box Construction w/ Packing (Graphite Impregnated Teflon)

Note: Equipped with NEOPRENE coupling

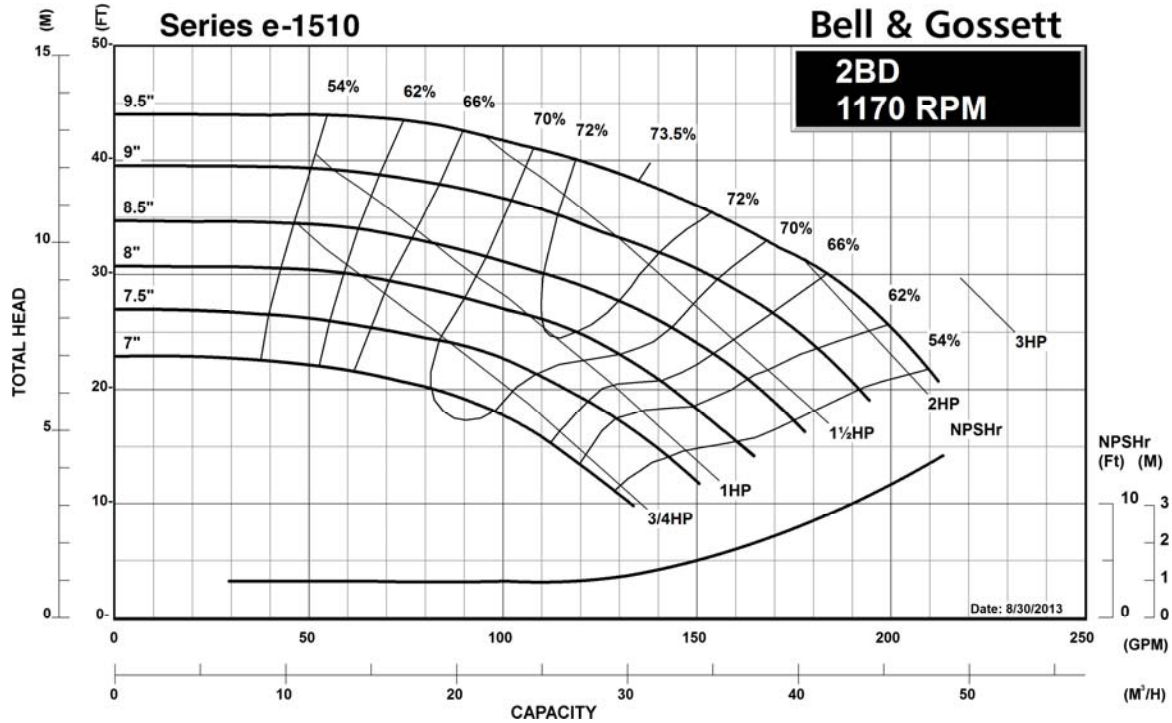

JOB: UNIT TAG: ENGINEER: CONTRACTOR:	REPRESENTATIVE: ORDER NO. SUBMITTED BY: APPROVED BY:	DATE: DATE: DATE:
---	---	--

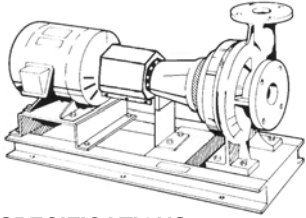

2BD

Series e-1510

Centrifugal Pumps - Base Mounted

SPECIFICATIONS

FLOW _____ HEAD _____

HP _____ RPM _____

VOLTS _____

CYCLE _____ PHASE _____

ENCLOSURE _____

APPROX. WEIGHT _____

SPECIALS _____

MATERIALS OF CONSTRUCTION

- Stainless Steel Fitted

FEATURES

- i-ALERT™ Condition Monitor
- ANSI/OSHA Coupling Guard
- Center Drop Out Spacer Coupling
- Fabricated Heavy Duty Baseplate

MAXIMUM WORKING PRESSURE

- 175 psi (12 bar) W.P.
w/ 125# ANSI flange drilling

TYPE OF SEAL

- Standard Seal (Buna-Carbon/Ceramic)
- F Standard Seal w/ Flush Line (Buna-Carbon/Ceramic)
- S Stuffing Box Construction w/ Flushed Mechanical Single Seal (EPR-Tungsten Carbide/Carbon)
- PF Stuffing Box Construction w/ Packing (Graphite Impregnated Teflon)

Note: Equipped with NEOPRENE coupling

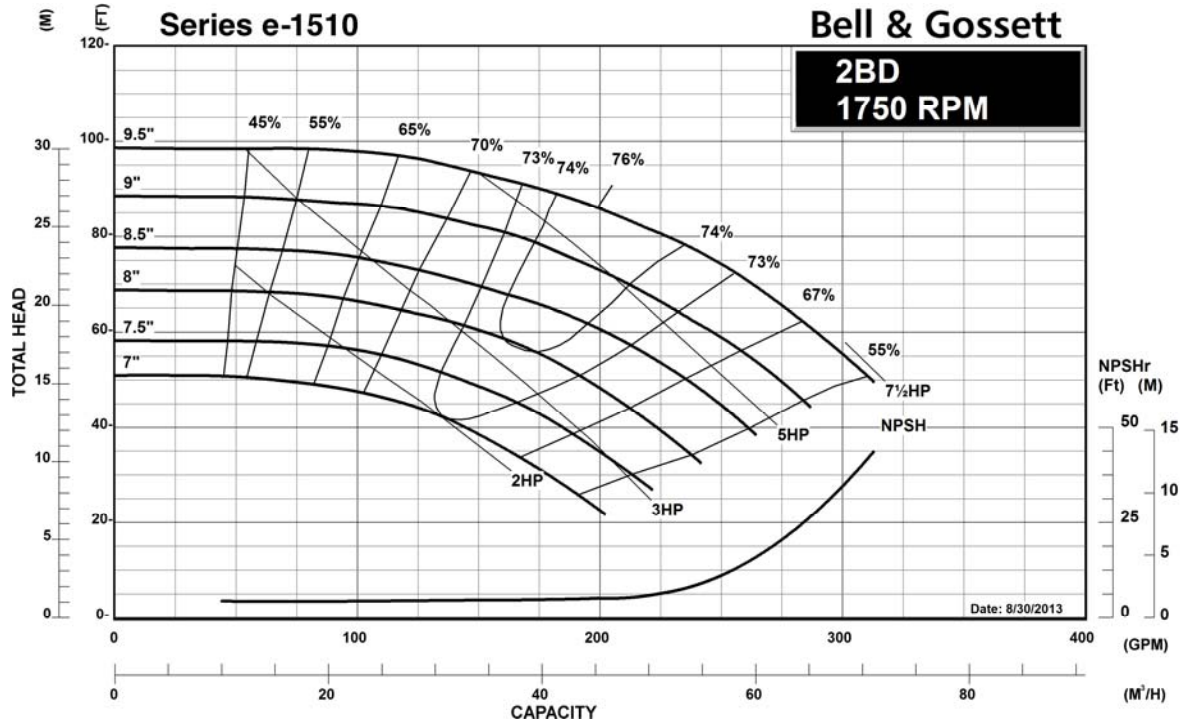

JOB:	REPRESENTATIVE:	
UNIT TAG:	ORDER NO.:	DATE:
ENGINEER:	SUBMITTED BY:	DATE:
CONTRACTOR:	APPROVED BY:	DATE:

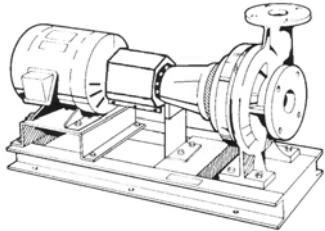

2BD Series e-1510 Centrifugal Pumps - Base Mounted

SPECIFICATIONS

FLOW _____ HEAD _____
 HP _____ RPM _____
 VOLTS _____
 CYCLE _____ PHASE _____
 ENCLOSURE _____
 APPROX. WEIGHT _____
 SPECIALS _____

MATERIALS OF CONSTRUCTION

- Stainless Steel Fitted

FEATURES

- i-ALERT™ Condition Monitor
- ANSI/OSHA Coupling Guard
- Center Drop Out Spacer Coupling
- Fabricated Heavy Duty Baseplate

MAXIMUM WORKING PRESSURE

- 175 psi (12 bar) W.P. w/ 125# ANSI flange drilling

TYPE OF SEAL

- Standard Seal (Buna-Carbon/Ceramic)
- F Standard Seal w/ Flush Line (Buna-Carbon/Ceramic)
- S Stuffing Box Construction w/ Flushed Mechanical Single Seal (EPR-Tungsten Carbide/Carbon)
- PF Stuffing Box Construction w/ Packing (Graphite Impregnated Teflon)

Note: Equipped with NEOPRENE coupling

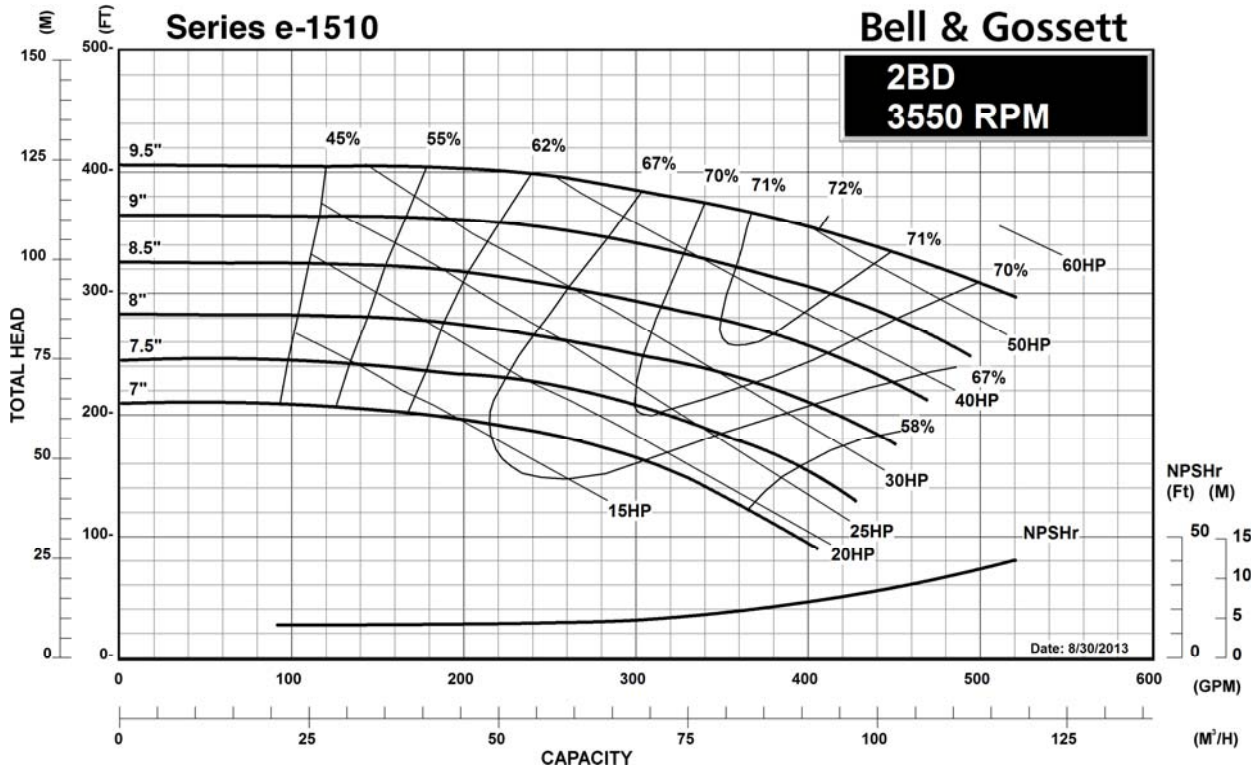

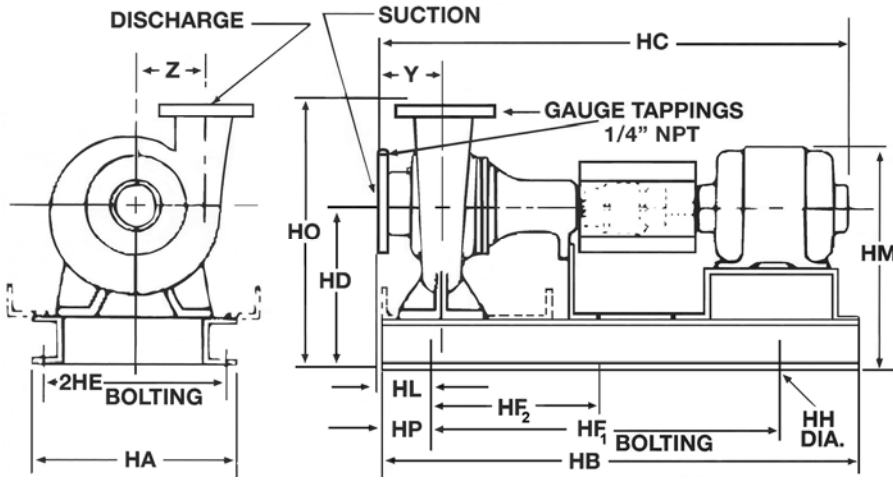

FLANGE DIMENSIONS IN INCHES (MM)			
	SIZE	THICKNESS	O.D.
Discharge	2"	7/8" (22)	6-1/4" (159)
Suction	2-1/2"	1" (25)	7-3/8" (187)

FLANGES ARE 125# ANSI - STANDARD

DIMENSIONS - Inches (mm)

STANDARD SEAL

MOTOR FRAME	HA	HB	HC MAX	HD	2HE	HF ₁	HF ₂	HH	HL	HM MAX	HO	HP	Y	Z
"S" FRAME														
143T	14-5/8 (371)	31 (787)	29-1/2 (749)	10-3/4 (273)	12-7/8 (327)	25 (635)	-	3/4 (19)	2-11/16 (68)	14-1/2 (368)	17-3/4 (451)	3 (76)	4 (102)	5-7/8 (149)
145T	14-5/8 (371)	31 (787)	30-1/2 (775)	10-3/4 (273)	12-7/8 (327)	25 (635)	-	3/4 (19)	2-11/16 (68)	14-1/2 (368)	17-3/4 (451)	3 (76)	4 (102)	5-7/8 (149)
182T	14-5/8 (371)	31 (787)	33-1/8 (841)	10-3/4 (273)	12-7/8 (327)	25 (635)	-	3/4 (19)	2-11/16 (68)	16 (406)	17-3/4 (451)	3 (76)	4 (102)	5-7/8 (149)
184T	14-5/8 (371)	31 (787)	33-7/8 (860)	10-3/4 (273)	12-7/8 (327)	25 (635)	-	3/4 (19)	2-11/16 (68)	16 (406)	17-3/4 (451)	3 (76)	4 (102)	5-7/8 (149)
213T	14-5/8 (371)	34-5/8 (879)	36-1/2 (927)	10-3/4 (273)	12-7/8 (327)	28-5/8 (727)	-	3/4 (19)	2-11/16 (68)	16-5/8 (422)	17-3/4 (451)	3 (76)	4 (102)	5-7/8 (149)

MOTOR FRAME	HA	HB	HC MAX	HD	2HE	HF ₁	HF ₂	HH	HL	HM MAX	HO	HP	Y	Z
"L" FRAME														
215T	14-5/8 (371)	39-3/8 (1000)	42-3/8 (1076)	10-3/4 (273)	12-7/8 (327)	33-3/8 (848)	-	3/4 (19)	2-11/16 (68)	16-5/8 (422)	17-3/4 (451)	3 (76)	4 (102)	5-7/8 (149)
254T	16 (406)	46-1/2 (1181)	46-1/8 (1172)	12 (305)	14 (356)	36-1/2 (927)	18-1/4 (464)	7/8 (22)	3-13/16 (97)	18-7/8 (479)	19 (483)	5 (127)	4 (102)	5-7/8 (149)
256T	16 (406)	46-1/2 (1181)	47-7/8 (1216)	12 (305)	14 (356)	36-1/2 (927)	18-1/4 (464)	7/8 (22)	3-13/16 (97)	18-7/8 (479)	19 (483)	5 (127)	4 (102)	5-7/8 (149)
284TS	16 (406)	46-1/2 (1181)	47-1/8 (1197)	13 (330)	14 (356)	36-1/2 (927)	18-1/4 (464)	7/8 (22)	3-13/16 (97)	21 (533)	20 (508)	5 (127)	4 (102)	5-7/8 (149)
286TS	16 (406)	46-1/2 (1181)	48-5/8 (1235)	13 (330)	14 (356)	36-1/2 (927)	18-1/4 (464)	7/8 (22)	3-13/16 (97)	21 (533)	20 (508)	5 (127)	4 (102)	5-7/8 (149)
324TS	16 (406)	46-1/2 (1181)	50-5/8 (1286)	12 (305)	14 (356)	36-1/2 (927)	18-1/4 (464)	7/8 (22)	3-13/16 (97)	21-1/8 (537)	19 (483)	5 (127)	4 (102)	5-7/8 (149)
326TS	16 (406)	46-1/2 (1181)	52-1/8 (1324)	12 (305)	14 (356)	36-1/2 (927)	18-1/4 (464)	7/8 (22)	3-13/16 (97)	21-1/8 (537)	19 (483)	5 (127)	4 (102)	5-7/8 (149)

STUFFING BOX

MOTOR FRAME	HA	HB	HC MAX	HD	2HE	HF ₁	HF ₂	HH	HL	HM MAX	HO	HP	Y	Z
"S" FRAME														
143T	14-5/8 (371)	34-5/8 (879)	33 (838)	10-3/4 (273)	12-7/8 (327)	28-5/8 (727)	-	3/4 (19)	2-11/16 (68)	14-1/2 (368)	17-3/4 (451)	3 (76)	4 (102)	5-7/8 (149)
145T	14-5/8 (371)	34-5/8 (879)	34 (864)	10-3/4 (273)	12-7/8 (327)	28-5/8 (727)	-	3/4 (19)	2-11/16 (68)	14-1/2 (368)	17-3/4 (451)	3 (76)	4 (102)	5-7/8 (149)
182T	14-5/8 (371)	34-5/8 (879)	36-3/4 (933)	10-3/4 (273)	12-7/8 (327)	28-5/8 (727)	-	3/4 (19)	2-11/16 (68)	16 (406)	17-3/4 (451)	3 (76)	4 (102)	5-7/8 (149)
184T	14-5/8 (371)	34-5/8 (879)	37-1/2 (953)	10-3/4 (273)	12-7/8 (327)	28-5/8 (727)	-	3/4 (19)	2-11/16 (68)	16 (406)	17-3/4 (451)	3 (76)	4 (102)	5-7/8 (149)
213T	14-5/8 (371)	39-3/8 (1000)	40 (1016)	10-3/4 (273)	12-7/8 (327)	33-3/8 (848)	-	3/4 (19)	2-11/16 (68)	16-5/8 (422)	17-3/4 (451)	3 (76)	4 (102)	5-7/8 (149)

MOTOR FRAME	HA	HB	HC MAX	HD	2HE	HF ₁	HF ₂	HH	HL	HM MAX	HO	HP	Y	Z
"L" FRAME														
215T	16 (406)	46-1/2 (1181)	44-3/4 (1137)	12 (305)	14 (356)	36-1/2 (927)	18-1/4 (464)	7/8 (22)	3-13/16 (97)	17-7/8 (454)	19 (483)	5 (127)	4 (102)	5-7/8 (149)
254T	16 (406)	51-3/4 (1314)	48-1/2 (1232)	12 (305)	14 (356)	41-3/4 (1060)	20-7/8 (530)	7/8 (22)	3-13/16 (97)	18-7/8 (479)	19 (483)	5 (127)	4 (102)	5-7/8 (149)
256T	16 (406)	51-3/4 (1314)	50-1/4 (1276)	12 (305)	14 (356)	41-3/4 (1060)	20-7/8 (530)	7/8 (22)	3-13/16 (97)	18-7/8 (479)	19 (483)	5 (127)	4 (102)	5-7/8 (149)
284TS	16 (406)	51-3/4 (1314)	49-5/8 (1260)	13 (330)	14 (356)	41-3/4 (1060)	20-7/8 (530)	7/8 (22)	3-13/16 (97)	21 (533)	20 (508)	5 (127)	4 (102)	5-7/8 (149)
286TS	16 (406)	51-3/4 (1314)	51-1/8 (1299)	13 (330)	14 (356)	41-3/4 (1060)	20-7/8 (530)	7/8 (22)	3-13/16 (97)	21 (533)	20 (508)	5 (127)	4 (102)	5-7/8 (149)
324TS	16 (406)	51-3/4 (1314)	53 (1346)	12 (305)	14 (356)	41-3/4 (1060)	20-7/8 (530)	7/8 (22)	3-13/16 (97)	21-1/8 (537)	19 (483)	5 (127)	4 (102)	5-7/8 (149)
326TS	16 (406)	51-3/4 (1314)	54-1/2 (1384)	12 (305)	14 (356)	41-3/4 (1060)	20-7/8 (530)	7/8 (22)	3-13/16 (97)	21-1/8 (537)	19 (483)	5 (127)	4 (102)	5-7/8 (149)

Dimensions are subject to change. Not to be used for construction purposes unless certified.

Xylem Inc.
8200 N. Austin Avenue
Morton Grove, IL 60053
Phone: (847)966-3700
Fax: (847)965-8379
www.bellgossett.com

