

291-5 (B39)

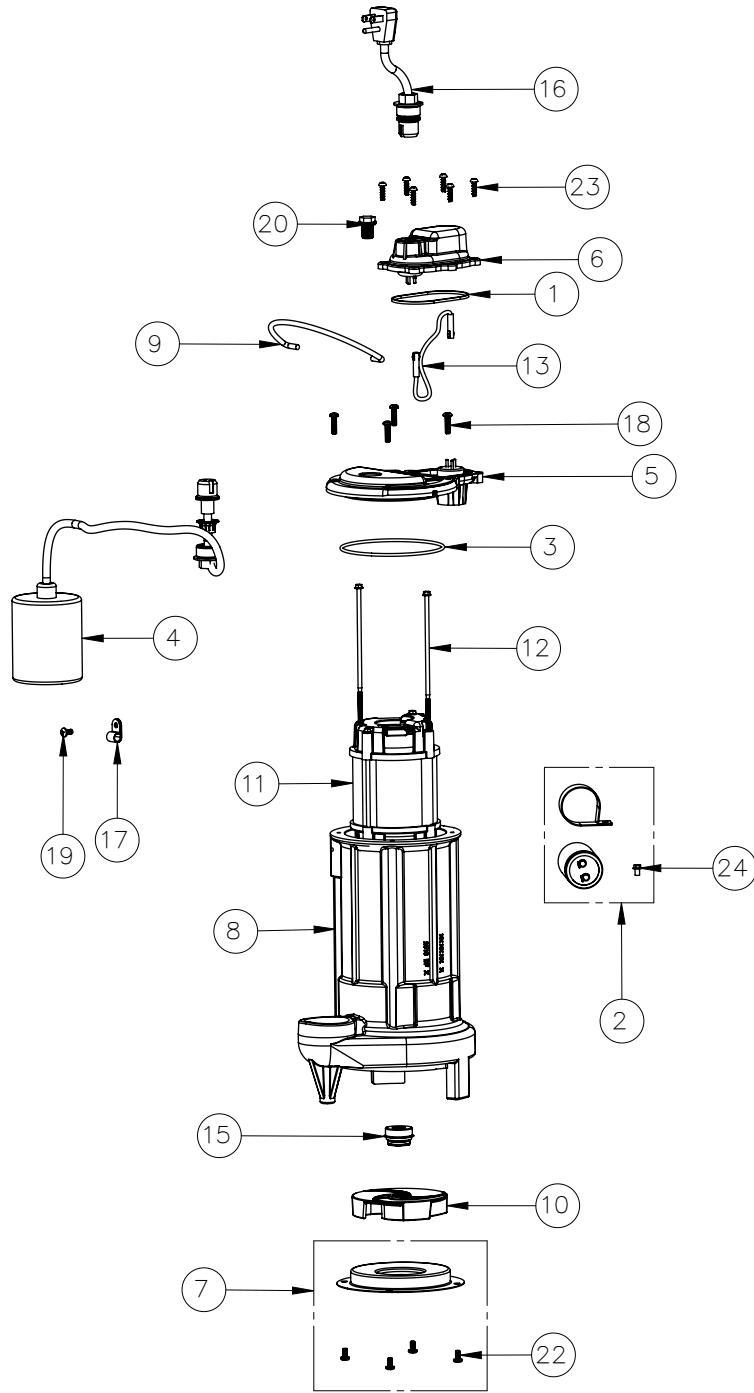

## 291-5 (B39)

#	PART #	DESCRIPTION	QTY	Note
1	K001046	SEALRING, CHAMBER COVER	1	
2	K001350	CAPACITOR KIT	1	
3	2357000	O-RING	1	[1]
4	K001080	2405000 MECHANICAL SWITCH W/ QUICKPLUG	1	
5	240600B	MOTOR COVER	1	
6	240700B	CHAMBER COVER	1	
7	K001349	290 SERIES STAMPING INLET KIT	1	
8	290300J	CAST IRON HOUSING	1	
9	K001082	HANDLE	1	
10	K001351	290 SERIES IMPELLER KIT	1	
11	2425200	115V 2-POLE MOTOR	1	[1]
12	2904E20	8-32 SCREW 5.688	1	
13	2074000	JUMPER WIRE WITH TERMINALS	2	
15	50980A0	1/2 INCH UNITIZED SEAL	1	[1]
16	K001345	POWER CORD, 50FT.	1	
17	8014000	CABLE CLAMP	1	
18	8072000	#10 - 24 x 3/4" SCREW	4	
19	8082000	#10-24 x 3/8 EPOXY LOCK SCREW	1	
20	8089000	OIL PLUG, O-RING ASSEMBLY	1	
22	8092000	#10 - 24 x 3/8" SCREW	4	
23	8104200	#10 HILO X 5/8" STAINLESS STEEL SCREW	6	
24	8160000	CAPACITOR SCREW	1	[1]

**PART NOTES:**

[1] - Part requires factory authorized service. Contact Liberty Pumps at 1-800-543-2550