

283HV-2 (B11)

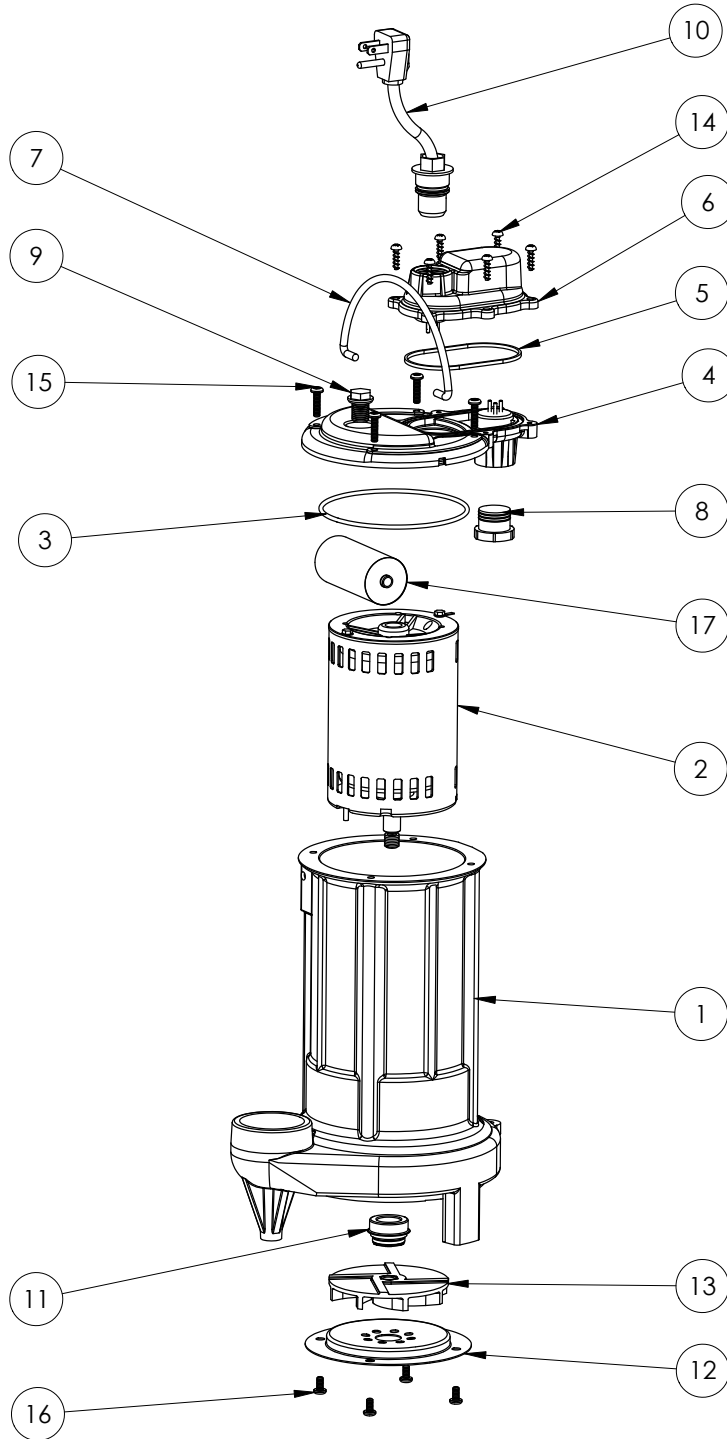

283HV-2**283HV-2 (B11)**

#	PART #	DESCRIPTION	QTY	Note
1	25160AG	CAST IRON HOUSING WITH HOLE	1	
2	2522000	MOTOR, .5HP 230V	1	[1]
3	2357000	O-RING	1	[1]
4	240600G	MOTOR COVER, GREY	1	
5	K001046	SEALRING, CHAMBER COVER	1	
6	240700G	CHAMBER COVER, GREY	1	
7	K001082	HANDLE	1	
8	8105000	PROTECTIVE CAP	1	
9	8089000	OIL PLUG, O-RING ASSEMBLY	1	
10	K001059	POWER CORD, 230V, 25 FOOT CORD	1	
11	5098000	1/2 INCH UNITIZED SEAL	1	
12	2414000	280 SERIES STAMPING INLET	1	
13	K001091	280 SERIES IMPELLER KIT	1	
14	8104200	#10 HILO X 5/8" STAINLESS STEEL SCREW	6	
15	8072000	#10 - 24 x 3/4" SCREW	4	
16	8092000	#10 - 24 x 3/8" SCREW	4	
17	2521000	CAPACITOR	1	

PART NOTES:

[1] - Part requires factory authorized service. Contact Liberty Pumps at 1-800-543-2550