

280-2 (B20)

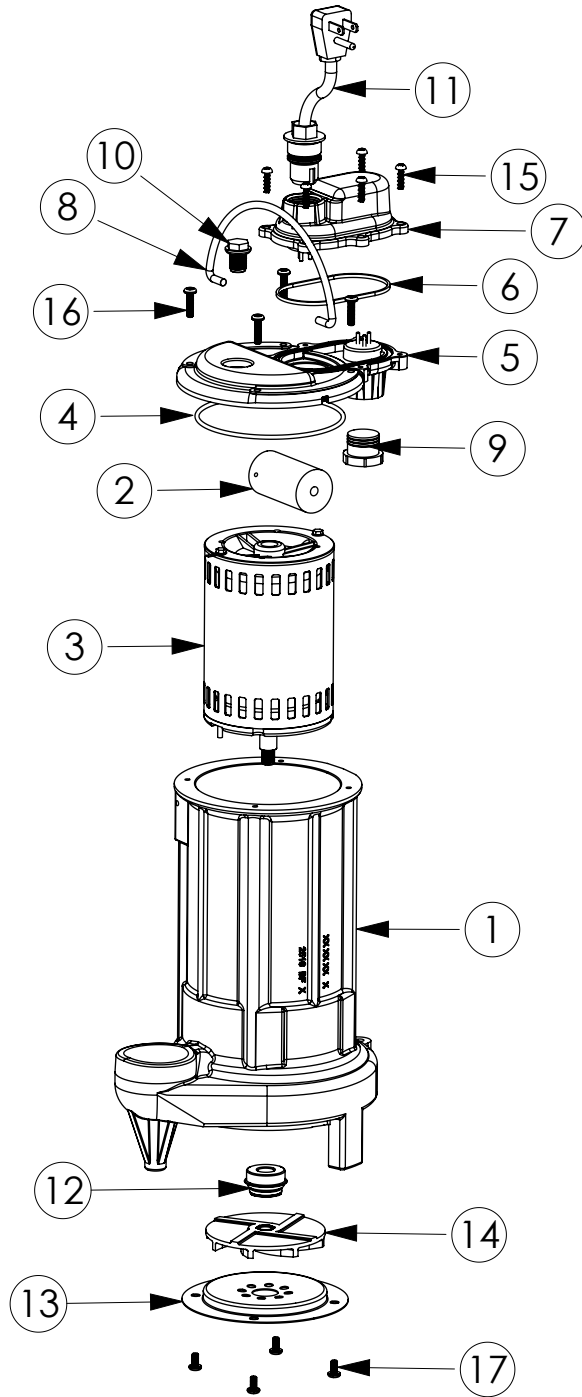

**280-2****280-2 (B20)**

#	PART #	DESCRIPTION	QTY	Note
1	25160AG	CAST IRON HOUSING WITH HOLE	1	
2	25200B0	CAPACITOR	1	[1]
3	2517000	MOTOR, .8 HP	1	
4	2357000	O-RING	1	[1]
5	240600G	MOTOR COVER, GREY	1	
6	K001046	SEALRING, CHAMBER COVER	1	
7	240700G	CHAMBER COVER, GREY	1	
8	K001082	HANDLE	1	
9	8105000	PROTECTIVE CAP	1	
10	8089000	OIL PLUG, O-RING ASSEMBLY	1	
11	K001008	POWER CORD, 115V, 25 FOOT CORD	1	
12	50980A0	1/2 INCH UNITIZED SEAL	1	[1]
13	2414000	280 SERIES STAMPING INLET	1	
14	K001091	280 SERIES IMPELLER KIT	1	
15	8104200	#10 HILO X 5/8" STAINLESS STEEL SCREW	6	
16	8072000	#10 - 24 x 3/4" SCREW	4	
17	8092000	#10 - 24 x 3/8" SCREW	4	

**PART NOTES:**

[1] - Part requires factory authorized service. Contact Liberty Pumps at 1-800-543-2550