

251 (B51)

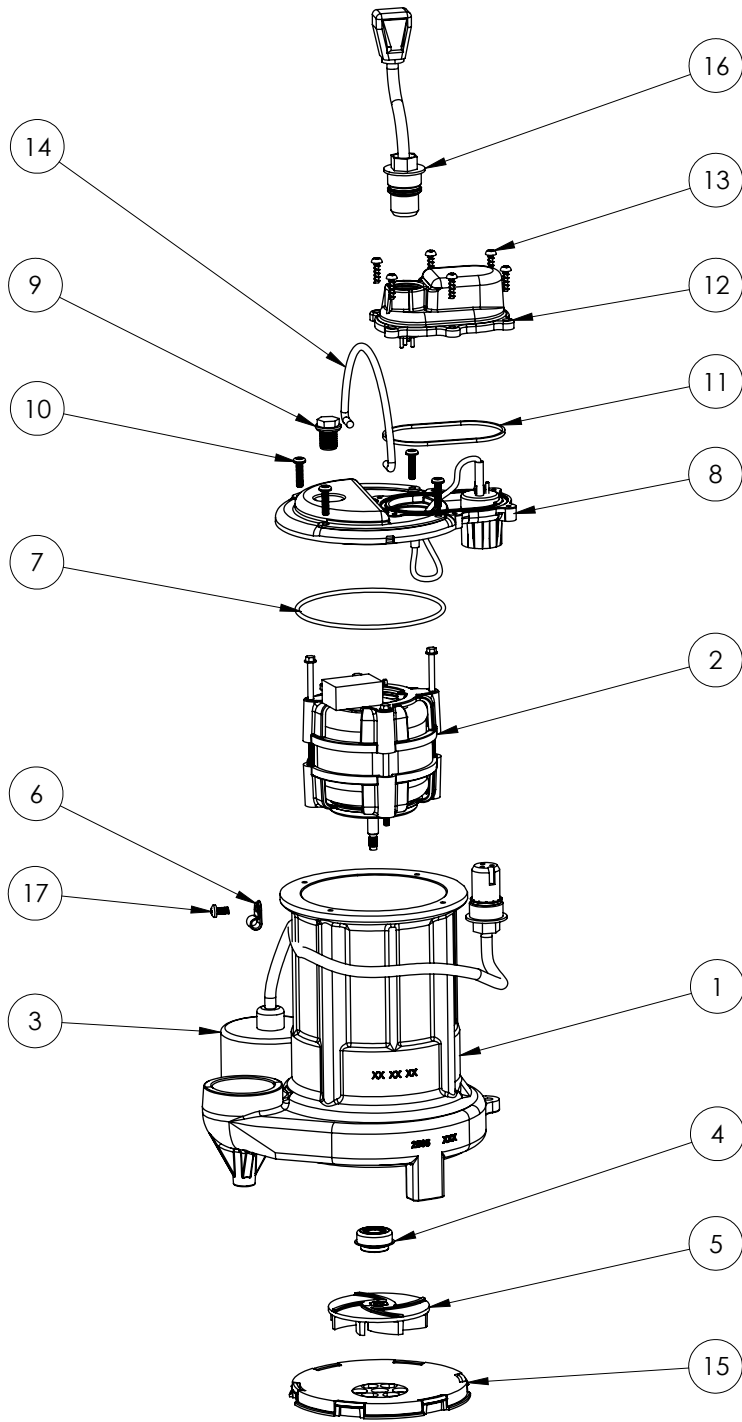

251 (B51)

#	PART #	DESCRIPTION	QTY	Note
1	25050CJ	CAST IRON HOUSING WITH HOLE FOR SWITCH	1	
2	2415200	PSC MOTOR	1	[1]
3	K001080	2405000 MECHANICAL SWITCH W/ QUICKPLUG	1	
4	2309000	5/16 SHAFT SEAL	1	
5	K001331	IMPELLER	1	
6	8014000	CABLE CLAMP	1	
7	2357000	O-RING	1	[1]
8	240600B	MOTOR COVER	1	
9	8089000	OIL PLUG, O-RING ASSEMBLY	1	
10	8072000	#10 - 24 x 3/4" SCREW	4	
11	K001046	SEALRING, CHAMBER COVER	1	
12	240700B	CHAMBER COVER	1	
13	8104200	#10 HILO X 5/8" STAINLESS STEEL SCREW	6	
14	K001082	HANDLE	1	
15	2502000	PLASTIC SCREEN	1	
16	K001010	POWER CORD, 115V, 10 FOOT CORD	1	
17	8082000	#10-24 x 3/8 EPOXY LOCK SCREW	1	

PART NOTES:

[1] - Part requires factory authorized service. Contact Liberty Pumps at 1-800-543-2550