



FMX09



FUMEX

Model: FX
Upblast Roof Exhausters
Direct Drive and Belt Drive

MOVING YOUR WAY

› **Fumex Direct Drive Series**

Model: FX (V/S/R/Q/Q1/Q2)

- Static pressure up to 1.5 in. wg.
- Flow capacity up to 4,489 CFM
- Fatrap (FT) Option Available on sizes 13, 16, & 18
- High wind construction (-HW) option available.

› **Fumex Standard Duty Belt Drive Series**

Model: FX (B)

- Static pressure up to 2.5 in. wg.
- Flow capacity up to 21,511 CFM
- Fatrap (FT) Option Available
- Heat & Smoke Removal (-HS) Option Available
- High wind construction (-HW) option available.

› **Fumex High Pressure Belt Drive Series**

Model: FX (BH)

- Static pressure up to 4 in. wg.
- Flow capacity up to 9,920 CFM
- Fatrap (FT) Option Available
- Heat & Smoke Removal (-HS) Option Available
- High wind construction (-HW) option available.

› **Fumex High Capacity Belt Drive Series**

Model: FMX (B)

- Static pressure up to 1.5 in. wg.
- Flow capacity up to 31,881 CFM



Introduction.....2

Features & Benefits.....3

Options and Accessories.....4

 - Fatrap UL762.....5

 - Heat & Smoke Removal.....6

 - High Wind Construction.....6

Motor Availability.....6

Direct Drive Dimensional & Performance Data.....8

Belt Drive Dimensional & Performance Data.....12

Engineering Specifications.....27

Limited Warranty.....IBC

› **Fumex Direct & Belt Drive Fans**

PennBarry certifies that the Fumex direct drive and belt drive models FX, FXB, FXBH, and FXBHFT shown herein are licensed to bear the AMCA Seal. The ratings shown are based on tests and procedures performed in accordance with AMCA Publication 211 and Publication 311 and comply with the requirements of the AMCA Certified Ratings Program.



› **Fumex High Capacity Belt Drive Fans**

PennBarry certifies that the Fumex belt drive model FMXB shown herein is licensed to bear the AMCA Seal. The ratings shown are based on tests and procedures performed in accordance with AMCA Publication 211 and comply with the requirements of the AMCA Certified Ratings Program.



› **UL and CSA Certification**

Fumex fans carry the UL label, UL 705 (ZACT), File #E28413. Fumex fans with the “Fatrap” option are UL 762 (YZHW) listed under file #MH10684. Fumex fans with the heat and smoke removal option are UL listed under file #MH19473.



Fumex exhausters are also certified by the Canadian Standard Association file #LR13309.



PennBarry reserves the right to make changes at any time, without notice, to models, construction, specifications, options, availability, etc. This bulletin illustrates the appearance of PennBarry products at the time of publication. To view the latest updates, visit PennBarry at www.pennbarry.com.

General Information

Centrifugal Fans



Belt Drive Fumex with Fatrap option (above) and Direct Drive Fumex (right).

› Fumex Series of Centrifugal Fans

Fumex centrifugal fans are designed for medium to high pressure applications. They can be either roof or wall mounted. While suitable for general ventilation, Fumex fans are specifically designed to discharge contaminated or grease-laden air or fumes up and away from building surfaces. The optional “Fatrap” (UL762) restaurant grease exhaust configuration (see Fatrap Configuration) makes Fumex fans particularly suited for all food service applications and chemical fume hoods. The optional heat and smoke removal configuration (see Smoke Removal) makes Fumex fans particularly suited for heat and smoke control systems. The optional high wind construction makes Fumex Fans particularly suited for high wind hurricane zones. Fumex fans are available in a range of capacities.

Fumex fans feature a weather-resistant seamless spun aluminum housing which provides ample drainage and works in conjunction with a patented wheel design and deeply spun inlets to provide smooth quiet airflow through the ventilator. The centrifugal wheels are aluminum, non-overloading, backward inclined, robotically welded, and dynamically balanced.

› Fumex Direct Drive Series

Model: FX (V/S/R/Q/Q1/Q2)

- Static pressure up to 1.5 in. wg.
- Flow capacity up to 4,489 CFM
- Fatrap (FT) Option Available on sizes 13, 16, & 18
- High wind construction (-HW) option available.

› Fumex Standard Duty Belt Drive Series

Model: FX (B)

- Static pressure up to 2.5 in. wg.
- Flow capacity up to 21,511 CFM
- Fatrap (FT) Option Available
- Heat & Smoke Removal (-HS) Option Available
- High wind construction (-HW) option available.

› Fumex High Pressure Belt Drive Series

Model: FX (BH)

- Static pressure up to 4 in. wg.
- Flow capacity up to 9,920 CFM
- Fatrap (FT) Option Available
- Heat & Smoke Removal (-HS) Option Available
- High wind construction (-HW) option available.

› Fumex High Capacity Belt Drive Series

Model: FMX (B)

- Static pressure up to 1.5 in. wg.
- Flow capacity up to 31,881 CFM



Belt Drive Fumex Cutaway

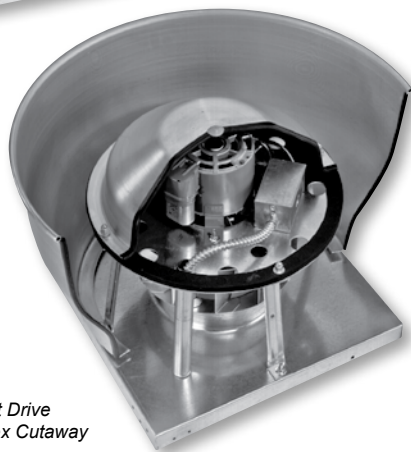

Direct Drive Fumex Cutaway

F
u
m
e
x

› Motor Selection

Both direct drive and belt drive models are available with a wide range of voltages and enclosures (see Motor Selection for a complete listing). Standard belt drive Open Drip Proof (ODP) ball bearing motors are selected using a conservative portion of the NEMA service factor. Standard direct drive ODP motors have Class B insulation and internal overload protection. Overload protection is available as an option on belt drive models. Each size is carefully engineered to match the motor to the wheel capacity.

› Internal Wiring

All direct and belt drive models with ODP motors feature a polarized disconnect plug which is factory wired from the motor to the junction box. This provides a positive method of electric shut-off as required by most codes without requiring the traditional disconnect switch. (See Options & Accessories for optional NEMA wiring and disconnect devices.)

› Sound Performance

Fumex units deliver outstanding air performance with minimal noise and have the lowest AMCA licensed sound performance in the industry.

› Curb Caps (Base)

Curb caps for direct drive and standard duty belt drive models are available in galvanized steel (standard) or aluminum (optional). Curb caps for high capacity belt drive models are available only in aluminum. All curb caps have fully welded corners and are pre-punched to ensure a leak-tight and easy installation.

› Forced Motor Cooling

Motors and drive components are located out of the airstream in a separate compartment. A cooling tube between the motor dome and discharge apron enables fresh air to be drawn into the motor housing during fan operation. This positive cooling promotes longer life for motor and drive components.

› Easy Maintenance Access

By removing the fasteners, the motor dome lifts off for complete access to all the drive components.

› Vibration Isolators

Multidirectional, rubber-in-shear vibration isolators mitigate residual vibration transmission from the unit to the building.

› Structural Integrity

Durable housings of spun aluminum have a high strength-to-weight ratio and incorporate a rolled bead for additional strength. There are no welds to break or seams to leak. The heavy-gauge motor mounting platform provides positive rigidity between all components of the power train assembly.

› Internal Bracing

Tri-Strut™ supports transfer the weight of the motor mounting platform directly to the curb mounting surface. The aluminum spun housing, therefore, is not used to support any weight. For grease laden applications, there is less surface for grease build-up during normal operation.

› Solid Steel Shafts

Sized so the first critical speed is a minimum of 130% of maximum cataloged operating speed, shafts are precision ground, and polished.

› Self-Aligning Bearings

Heavy-duty bearings are sized for a minimum L50 life in excess of 200,000 hours of operation. 100% factory tested, they are designed for air handling applications.

› Drives and Belts

Pulleys are pre-set to the specified RPM. Cast iron variable pitch pulleys are adjustable, allowing for field balancing based on actual field conditions. All pulleys are sized for at least 150% of the driven horsepower.

› Conduit

Both direct and belt drive units include a large 1" nominal conduit chase (not available on heat and smoke removal units; wiring is run via the cooling tubes) for easy installation of wiring from the motor dome to below the curb cap. Fatrap units are factory wired to an external NEMA 3R junction box.

› Reverse Venturi

Reverse venturi reduces turbulence and improves distribution of the air as it enters the wheel inlet and is "captured" by the blades.



› Wheels

Fumex fans offer patented wheel designs. Carefully matched, highly-tooled venturis enhance the performance of these backward inclined and non-overloading centrifugal wheels. Made of advanced aluminum alloys, the various wheel components provide superior strength and durability, as well as spark resistant construction. The heat and smoke removal configuration utilizes steel construction.

› Silent Wheel (Direct Drive)

- Blades' highly curved leading edge provide unsurpassed low sound numbers with excellent air performance.
- Backplate and inlet are stamped for consistency, plus dynamic balancing assure smooth, vibration-free operation.
- Riveted or riveted and welded construction ensure superior dependability over other wheel designs.

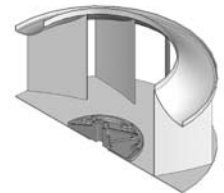

› Standard Duty, All Welded Wheel

(Standard Duty and High Pressure Belt Drive)

- Blades are curved for improved air performance while increasing their strength and rigidity.
- Backplate and inlet are stamped for consistency. They include a perimeter rim which enhances strength and improves balancing.
- Wheel assembly is robotically welded to provide extremely durable and consistent performance.
- Wheel is dynamically balanced. Balancing weights are mechanically attached to the inside of the rims of both the backplate and wheel inlet. This allows a precise placement of the weights anywhere within a full 360° range on two separate planes, without the possibility of detachment.

Options & Accessories

› Finishes

Coatings such as Polyester Powder Coat, Epoxy Powder Coat, Phenolic Epoxy Powder Coat, and others are available. See the coatings brochure for details.

› Mounting Pedestal

The 12" high mounting pedestal, available in aluminum or galvanized steel, incorporates a removable access panel for easy inspection and service of motor operated backdraft dampers. It provides solid ventilator support and a weather resistant seal that does not injure or disturb flashing. This item should not be used with Fatrap units.

› Hinged Sub-Base

Hinged sub-bases provide access to the curb well for damper service or clean out for grease applications. Constructed with a rust proof hinge arrangement and low height (3 1/2") the assembly is easily manipulated and reduces the impact on overall installation height. This accessory is available for use with most all models for either factory built or existing roof curbs.

› Floating Hinge Kit

A floating hinge kit is also available for field installation. This assembly connects the exhauster directly to the roof curb and provides the same level of access as the hinged sub-base.

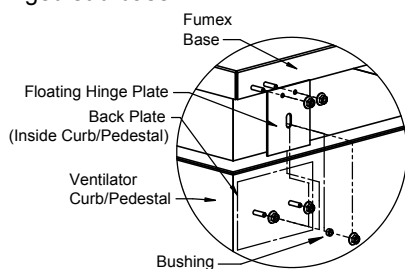

› Aluminum Bird and Insect Screen

Bird screens are available for all direct and belt drive models. An aluminum insect screen with a smaller mesh than the standard bird screen is also available. However, please note that NFPA 96 installations do not allow the use of bird or insect screens. The requirements of local codes must be reviewed to determine if there are any conflicts.

› Internal Wiring

NEMA 3R wiring is available for both direct and belt drive models.

› Backdraft Dampers

Backdraft dampers are available for either gravity or motorized operation (motor kit optional). Dampers feature square galvanized steel frame, multi-leaf, roll formed aluminum blades with nylon bearings. Backdraft dampers should not be used when venting kitchen hoods. NFPA 96 installations do not allow the use of dampers. The requirements of local codes must be reviewed to determine if there are any conflicts.

› Safety Disconnect Switch

Safety disconnect switches are available to allow positive electrical shut-off and safety. Switches are factory mounted when factory wiring is requested. Wiring is only run from the motor to the junction box. (Factory wiring of explosion proof applications is not available.) A wide range of NEMA rated enclosures with disconnect switches are available for indoor, outdoor, and explosion proof installations. Disconnects are to be field wired by a licensed electrician.



› Firestat Switch

Firestat switch automatically disconnects the unit when the temperature of the air being exhausted exceeds a preset rating.



› Time-Delay Switch

(Selected direct drive models only) The Airminder Model AM12 switch is a UL recognized and CSA certified time-delay relay that operates both the fan and room light to ventilate an area even after the occupants depart. In the "On" position, the Airminder turns the light and fan on immediately. In the "Off" position, the light goes off immediately and the fan is in operation for a period of time as preset from 1 to 60 minutes. Suitable only for 1/3 HP maximum at 120/1/60.



› Speed Controllers

The Lektrol™ controller allows adjustment in speed to a maximum of 50% reduction, which results in a very cost effective means for system balancing. The device can be located under the fan dome to prevent unauthorized tampering or on the wall for ease of operation by the building occupants. (Available on direct drive units with ODP motors and some select TE motors. See reference table under Motor Availability)



› Automatic Belt Tensioner

The factory mounted Automatic Belt Tensioner accessory eliminates the need for re-tensioning the belt after start-up. It is constructed from 10 gage galvanized steel and incorporates five torsion springs to automatically position the motor and maintain proper belt tension. Additional benefits include reduced belt and pulley wear and simplified belt replacement without tools. The Automatic Belt Tensioner is available for Fumex models FX08B, FX10B, FX12BH, FX13B, FX13BHFT and FX14B with 1/4, 1/2, 3/4, and 1 HP ODP motors. It can also be used with 1.5 HP, 3-phase ODP motors.

› Spark Resistant Construction

AMCA 'B' construction is available as standard construction on direct drive units and as an option on belt drive units (not available on heat and smoke removal units). If required, an explosion proof motor and disconnect may be selected as options.

› Wall Mounting

This option is provided as a separate product line, whose models include a "W" prefix. Product line includes models up to size 24, motors up to 2HP, and round bases (not available on heat and smoke removal units).

› Prefabricated Curb

A variety of sizes of prefabricated roof curbs are available. Galvanized steel unibeam curbs are the most popular. For a complete listing of all curb types and sizes available, see the latest PennBarry Ventilation Curb brochure. Please note that NFPA 96 installations require a specific curb height. See Fatrap configuration on the next page.

› Fumex Curb Dimensional Drawings

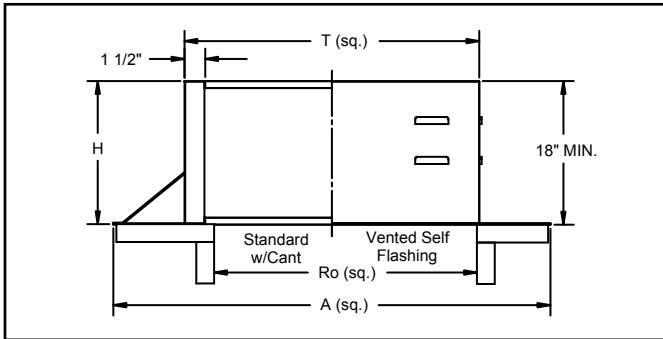

› Fumex Dimensional References

Model	E ⁽⁴⁾ SQ	T ⁽²⁾ SQ	A SQ	Ro ⁽³⁾ SQ	Damper Size SQ	Galv. Steel Gauge
FX08S/R	18.5	17	25	9	8.75	18
FX10S/R	18.5	17	25	11.5	11.25	18
FX11V/S/R/Q	18.5	17	25	11.5	11.25	18
FX13V/S/R/Q	18.5	17	25	11.5	11.25	18
FX16V/S/R/Q1/Q2	20.5	19	27	16	15.75	18
FX18V	28.5	27	35	20	19.75	18
FX08B to FX14B	24.75	23.25	31.25	16	15.75	18
FX12BH	24.75	23.25	31.25	16	15.75	18
FX13BHFT	24.75	23.25	31.25	16	15.75	18
FX16B and FX18B	28.5	27	35	20	19.75	18
FX18BH	28.5	27	35	20	19.75	18
FX24B	33.5	32	40	25	24.75	18
FX24BH	33.5	32	40	25	24.75	18
FX27B and FX30B	36.5	35	43	28	27.75	18
FX36B	44.5	43	51	36	35.5	18
FMX50B	59	57.5	65.5	50	49.5	18

Standard heights "H" are 8", 12", and 18" including wood nailer. "T" dimension of curb is 1 1/2" less than the dimension of inside base of fan ("E"). "Ro" refers to Roof Opening. "E" dimension is inside base of fan. For FT (Fatrap) units, curbs are cantless, 18" high and optionally vented.

› Fumex Exploded View

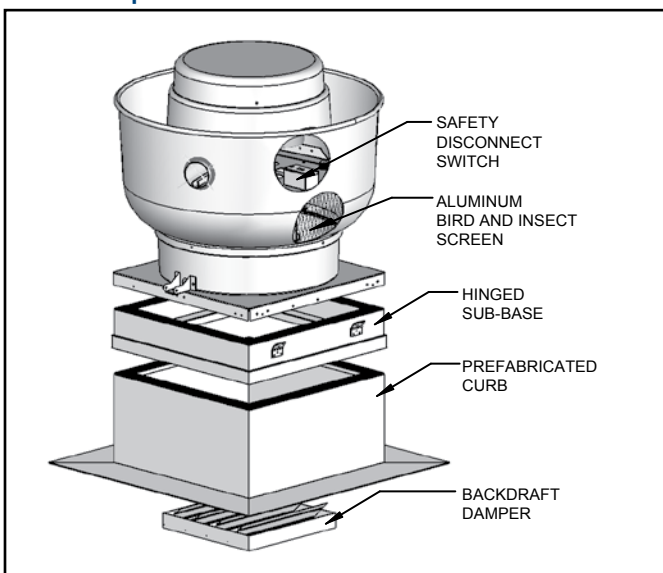

©PENNBARRY 2009

› Fatrap Configuration

Fatrap configured fans are ideal for use in commercial kitchens over grilles, charcoal broilers, deep fat fryers, steam tables, ranges, dishwashers, and other appliances. Fumex fans are specially configured for food service applications with the addition of a group of accessories that either meets a requirement or eases installation requirements according to NFPA 96. NFPA 96 "Standard for Ventilation Control and Fire Protection of Commercial Cooking Operations" is the generally recognized authority nationwide for restaurant installation requirements. However, local codes may vary.

Included in the units are the following.

- **UL 762 Listing:** Fatrap configured Fumex fans are listed at 400°F — 100°F higher than UL requirements. The high temperature rating is the result of the fan's highly efficient forced motor cooling capability. Three direct drive (sizes 13 – 18) and all belt drive models are listed.
- **Pre-wired Junction Box:** A weather-proof junction box is factory wired and mounted to the housing exterior. An appropriately sized disconnect switch is commonly selected as an additional option. These items meet the code requirements for positive electric shut-off.
- **Grease Collector/Separator Box:** Designed for easy installation, the grease is routed from a single swiveling collection spout to an amply sized durable galvanized steel box, trapping grease and residue, and avoiding discharge onto the roof surface. Additionally, these boxes separate the water from the grease, prolonging the time required between periodic maintenance.

› Additional Fatrap Accessories

Ventilated Curbs and Pedestals: For buildings two stories or higher NFPA 96 requires the use of ventilated mounting curbs or pedestals to provide an approved arrangement for connecting a range hood and duct work to the roof fan. PennBarry's ventilated mounting curbs and pedestals, 18" high, comply with that standard when properly installed. Ventilated curbs have a flat mounting flange for fastening directly to the roof deck. This flange should be securely fastened and flashed to ensure weather tightness. Ventilated pedestals are designed to fit on an existing curb. They provide cap flashing when so installed.

Make-Up Air Units (Suplex): Fumex fans with the Fatrap configuration can be combined with a PennBarry FS Muffan fan to create an integrated unit called the Suplex. The Fumex handles the required air flow to be exhausted while the Muffan provides an appropriate amount of supply make-up air. The modular design of the Suplex means that just one roof opening is needed for both the exhaust and supply ducts. An insulated shield divides the base to separate the exhaust and make-up air compartments, and prevents heat transfer between hot exhaust air and fresh filtered air. This results in a complete air-tight seal between the hood and exhaust fan.

Options & Accessories

Centrifugal Fans

› Heat & Smoke Removal Configuration

While Fumex fans are commonly used for general ventilation, they are also designed to discharge contaminated or grease-laden air or fumes up and away from building surfaces with the Fatrap option and when equipped with the Heat and Smoke Removal option, this series of fans incorporates features exclusively designed to exhaust heat and smoke in the event of fire. During these emergencies, the fans are designed to operate at the temperature and time limits stated below. To maintain power to these fans during emergencies, special consideration must be made for field power supply. In the event of an emergency, if power is maintained, the units will operate for the times and temperatures indicated, after which they will continue to operate until they are destroyed by the extreme temperature generated during an actual fire, or their roof structure collapses.

For smoke control systems, Heat and Smoke Removal configured fans are listed per UL for emergency smoke removal, referencing UL705, UL793, Industrial Risk Insurers (IRI), and Southern Building Code Congress International (SBCCI).

The UL standard requires the fan to run at 500°F for 4 hours (IRI) and 1000°F for 15 minutes (SBCCI). PennBarry Heat and Smoke Removal configured Fumex units are listed at 500°F for 4 hours and 1000°F for 1 hour. The additional 45 minutes at 1000°F will buy precious time in the event of a fire.

Steel Wheel: The wheel is a standard duty, all welded wheel (standard duty and high pressure belt drive). The blades are curved for improved air performance while increasing their strength and rigidity. The wheel assembly is fully welded to provide extremely durable and consistent performance. The wheel is dynamically balanced. Balancing weights are mechanically attached to the inside of the rims of both the backplate and wheel inlet. This allows a precise placement of the weights anywhere within a full 360° range on two separate planes, without the possibility of detachment.

Forced Motor Cooling: Motors and drive components are located out of the airstream in a separate compartment. Two cooling tubes are located between the motor dome and discharge apron which enables fresh air to be drawn into the motor compartment during fan operation. This allows the cooler outside air to wash over the motor and bearings. This positive cooling promotes longer life for the motor and drive components.

› Fumex Heat & Smoke Removal Option

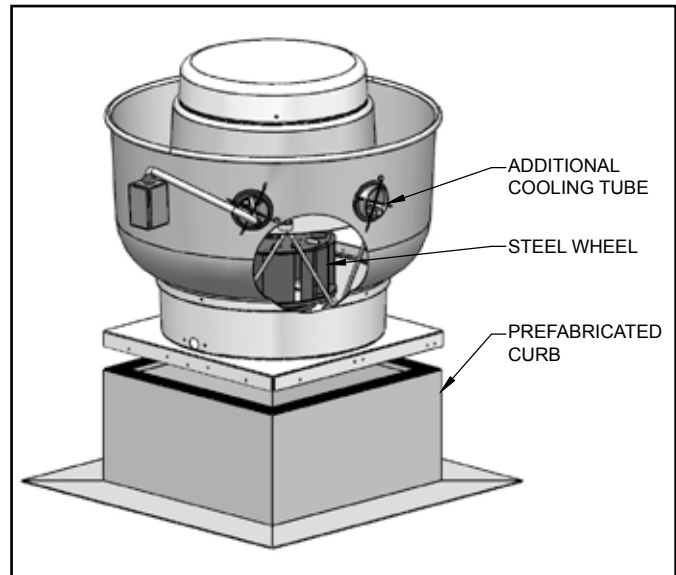

› High Wind Construction

High wind construction Fumex fans are specifically designed for high wind hurricane zones (HWHZ). The Fumex models are designed to withstand 150 MPH winds in accordance with Miami-Dade and Florida Building Code standards. The units are 3rd party tested and certified through a 3rd party Professional Engineer (P.E.) to meet these strict standards. Installation details are provided and since there are no tie downs or external braces required for attaching the unit to the roof or curb this makes installation simple and easy. A wide range is offered to meet all of your ventilation needs which includes all belt and direct drive sizes 36 and under.

Product Certifications:

- Miami-Dade NOA # 08-1202.13
- Florida Product Approval #12339
- Texas Department of Insurance # pending

F
u
m
e
x

› NEMA Motor

This chart summarizes the largest allowable NEMA frame sizes for motors used on belt drive models.

› Largest Available NEMA Frame Size per Model

Model	Max. Frame Size	Model	Max. Frame Size
FX08B	56	FX18B	145T
FX10B	56	FX18BH	145T
FX12BH	56	FX24B	184T
FX13B	56	FX24BH	184T
FX13BHFT	56	FX27B/FX30B	184T
FX14B	56	FX36B	213T
FX16B	145T	FMX50B	215T

! At PennBarry's option, large frame motors may be removed after testing and shipped separately. Contact the factory for special application motor availability.

› Variable Speed Motor Control

PennBarry offers Lek-Trol™ solid state controllers to alter the high speed of most direct drive motors by as much as 50%. If variable speed is required, check the Lek-Trol™ availability table below to verify that controllers exist for the fan model selected. Remember, Lek-Trol™ controllers are currently only available for direct drive motors including all standard Open Drip Proof (ODP) 60 Hz motors. Not all totally enclosed motors are currently available with variable speed control. Inverter rated motors suitable for use with variable frequency drives can be supplied for belt drive models. Contact your local PennBarry representative for availability.

› Available Lek-Trol Speed Controls

Model	60 Hz					50 Hz		
	ODP 115V	115V	200V	208V	230V	Totally Enclosed		
FX08S	-	-	-	-	-	-	-	-
FX08R	LT25	-	-	-	-	-	-	-
FX10S	-	-	-	-	-	-	-	-
FX10R	LT30	LT30	LT35	LT35	LT35	LT30	LT35	LT35
FX11V	-	-	-	-	-	-	-	-
FX11S	-	-	-	-	-	-	-	-
FX11R	LT30	-	-	-	-	-	-	-
FX11Q	LT50	-	-	-	-	-	-	-
FX13V	-	-	-	-	-	-	-	-
FX13S	-	-	-	-	-	-	-	-
FX13R	LT30	LT30	LT35	LT35	LT35	LT50	LT35	LT35
FX13Q	LT45	LT50	LT35	LT35	LT35	LT50	LT35	LT35
FX16V	-	-	-	-	-	-	-	-
FX16S	-	-	-	-	-	-	-	-
FX16R	LT50	-	-	-	-	-	-	-
FX16Q1	LT40	-	-	-	-	-	-	-
FX16Q2	LT75	-	-	-	-	-	-	-
FX18V	LT60	-	-	-	-	-	-	-

Lek-Trols™ indicated for multi-speed models (eg., FX16V/S/R) are applicable only for the high speed. Do not use on low or medium speed for multi-speed models. Items noted with (-) are not applicable.

› Direct Drive Motor Availability

The following chart lists the various motor options available for each of the direct drive fan models. Once a fan model is selected, this chart can be used to determine if a suitable motor is available. (If not, another selection may have to be made from the fan performance charts). Look under the nominal RPM heading to determine which fans have 2-speed and 3-speed motors.

› Direct Drive Motor Availability

Model	Nominal RPM				1 Phase									
	1050 V	1300 S	1550 R	1725 Q	115 Volts			200 - 240 Volts						
					Open Drip Proof	Totally Enclosed	Explosion Proof	Open Drip Proof	Totally Enclosed	50 Hz	50 C Ambient	Explosion Proof (4)		
FX08S/R	-	x	x	-	yes	yes (1)	-	Use TE Motors	yes (1)	yes (1)	yes (1)	-		
FX10S/R	-	x	x	-	yes	yes (1)	-		yes (1)	yes (1)	yes (1)	-		
FX11V/S/R	x	x	x	-	yes	yes (1)	-		yes (1)	yes (1)	yes (1)	-		
FX11Q	-	-	-	x	yes	yes	yes		yes	yes	yes	yes (5)		
FX13V/S/R	x	x	x	-	yes	yes (1)	-		yes (1)	yes (1)	yes (1)	-		
FX13Q	-	-	-	x	yes	yes	yes		yes	yes	yes	yes (5)		
FX16V/S/R	x	x	x	-	yes	yes (1)	-		yes (1)	yes (1)	yes (1)	-		
FX16Q1	-	-	-	x (3)	yes	-	-		-	-	-	-		
FX16Q2	-	-	-	x	yes	yes	yes		yes	yes	yes	yes (5)		
FX18V	x	-	-	-	yes	-	-		-	-	-	-		

Model	Nominal RPM				3 Phase					
	1050 V	1300 S	1550 R	1725 Q	200 - 460 Volts (2)					
					Open Drip Proof	Totally Enclosed	50 Hz	50 C Ambient	Explosion Proof (4)	
FX08S/R	-	x	x	-	Use TE Motors	-	-	-	-	-
FX10S/R	-	x	x	-		-	-	-	-	-
FX11V/S/R	x	x	x	-		-	-	-	-	-
FX11Q	-	-	-	x		-	-	-	-	yes (6)
FX13V/S/R	x	x	x	-		-	-	-	-	-
FX13Q	-	-	-	x		yes	yes	yes	yes	yes (6)
FX16V/S/R	x	x	x	-		-	-	-	-	-
FX16Q1	-	-	-	x (3)		-	-	-	-	-
FX16Q2	-	-	-	x		yes	yes	yes	yes	yes (6)
FX18V	x	-	-	-		-	-	-	-	-

(1) High speed only.; (2) 200 - 240, 380, 415, 460 V; (3) Nominal 1650 RPM; (4) Cls. I, Grp. D, Div. I / Cls. II, Grp. F & G, Div. I., Not available with 50 Hz.; (5) 230 V only. Not available in 200 or 208 V; (6) 230 V and 460 V only.

Dimensional Information & Performance Data

Fumex | Direct Drive



Centrifugal Fans

FX08, FX10, FX11, & FX13

Performance Data Overview

Fumex direct drive models are available with single and multi-speed motors. Multi-speed motors (eg., FX16V/S/R) are designated: V (1050 RPM), S (1300 RPM), and R (1550 RPM). FX18V is an exception, being a single speed motor. Q, Q2 (1725 RPM) and Q1 (1650 RPM) are single speed motors. A single Fumex fan may be suitable for several requirements by a simple wiring change. This feature provides flexibility for a variety of reasons, including energy savings, off hours requirements, future expansion, or unexpected field variations.

By using Lek-Trol™ variable speed controllers, the high speed flow rate of most models can be reduced by as much as 50%. Do not use Lek-Trol™ on medium or low speed for multi-speed models.

When compared to belt drive models, direct drive fans require less maintenance, have a simpler construction, cost less, and are lighter in weight.

Performances in 50 Hz applications will be less than shown below; consult your local PennBarry representative.

Fumex direct drive models are available in six sizes (8, 10, 11, 13, 16, and 18). Capacities up to 4500 CFM, with static pressures to 1 1/2".

FX08 - FX11 Direct Drive Fan Dimensional Data

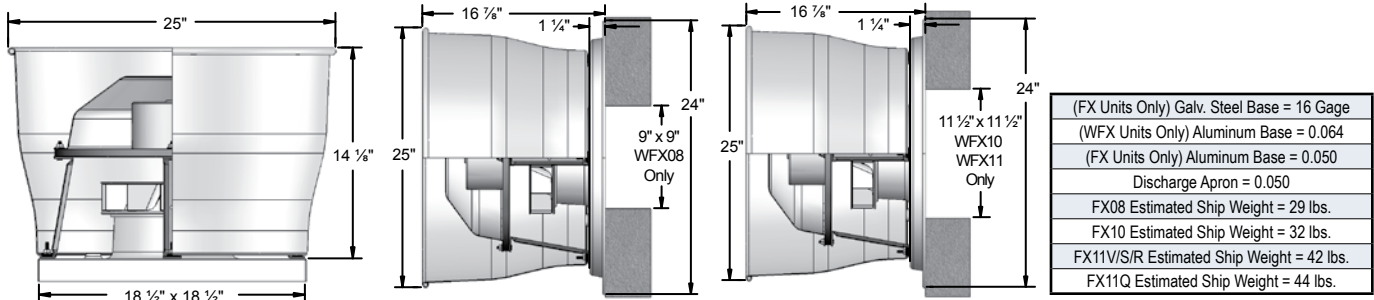

FX08 - FX11 Direct Drive Performance Data

Model	Nominal			Tip Speed FPM	0.000" SP		0.125" SP		0.250" SP		0.375" SP		0.500" SP		0.625" SP		0.750" SP		1.000" SP	
	HP	Max Watts	RPM		CFM	Sones	CFM	Sones	CFM	Sones	CFM	Sones	CFM	Sones	CFM	Sones	CFM	Sones	CFM	Sones
FX08S	1/50	44	1300	3361	247	1.3	150	2.0	94	3.2	54	4.3	-	-	-	-	-	-	-	-
FX08R	1/30	55	1550	4007	288	2.4	205	2.9	154	3.5	112	4.4	72	5.2	-	-	-	-	-	-
FX10S	1/25	85	1300	3361	400	3.5	309	3.8	246	4.1	194	4.6	152	5.0	109	5.5	57	6.1	-	-
FX10R	1/12	122	1550	4007	570	6.2	500	6.6	440	6.8	385	6.8	325	6.8	251	6.9	170	7.1	-	-
FX11V	1/25	103	1050	3058	406	1.9	225	2.2	151	3.6	119	4.2	87	4.8	57	5.5	-	-	-	-
FX11S	1/11	142	1300	3786	534	3.9	414	4.2	337	5.1	273	5.9	223	6.2	177	6.5	129	6.9	-	-
FX11R	1/7	199	1550	4514	760	7.6	667	7.4	586	7.6	512	7.9	434	8.9	359	9.6	283	9.6	118	9.7
FX11Q	1/5	255	1725	5024	1034	10.7	959	10.5	883	10.5	804	10.5	722	10.6	631	10.9	538	10.7	313	9.7

See notes on page 9.

FX13 Direct Drive Fan Dimensional Data

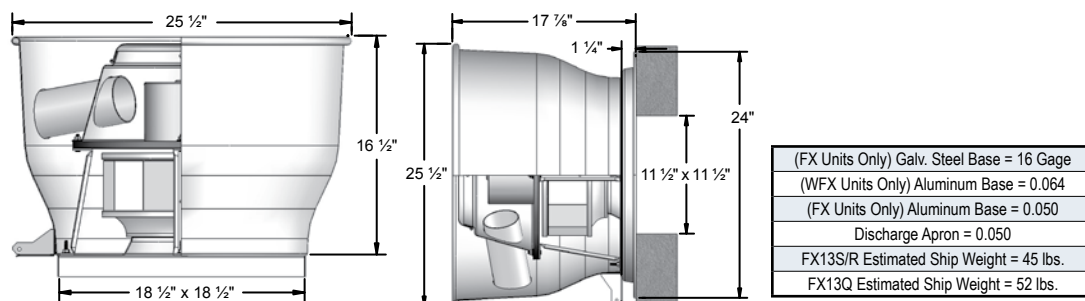

FX13 Direct Drive Performance Data

Model	Nominal			Tip Speed FPM	0.000" SP		0.125" SP		0.250" SP		0.375" SP		0.500" SP		0.625" SP		0.750" SP		1.000" SP		1.250" SP	
	HP	Max Watts	RPM		CFM	Sones	CFM	Sones	CFM	Sones	CFM	Sones	CFM	Sones	CFM	Sones	CFM	Sones	CFM	Sones	CFM	Sones
FX13V	1/20	113	1050	3221	640	4.2	469	2.8	317	2.4	250	3.1	197	3.8	149	4.5	106	5.2	-	-	-	-
FX13S	1/12	148	1300	3988	845	7.4	735	6.4	612	5.2	492	5.0	404	5.3	334	5.7	270	6.1	136	7.0	-	-
FX13R	1/6	188	1550	4755	1057	10.5	980	10.1	908	9.6	825	8.6	733	8.1	646	8.1	561	8.2	376	8.2	144	8.5
FX13Q	1/4	343	1725	5292	1261	13.6	1198	13.0	1143	12.6	1093	12.1	1033	11.7	973	11.2	909	10.8	757	10.1	515	9.6

See notes on page 9.

Fumex

©PENNBARRY 2019

› **FX16 Direct Drive Fan Dimensional Data**

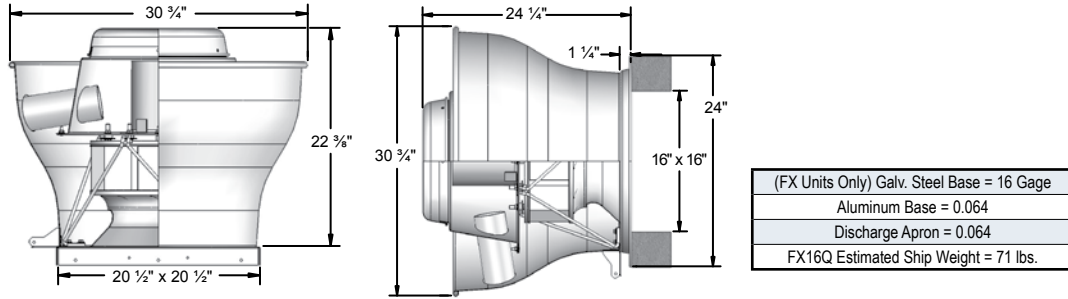

› **FX16 Direct Drive Performance Data**

Model	Nominal			Tip Speed FPM	0.000" SP		0.125" SP		0.250" SP		0.375" SP		0.500" SP		0.625" SP		0.750" SP		1.000" SP		1.250" SP		1.500" SP	
	HP	Max Watts	RPM		CFM	Sones	CFM	Sones	CFM	Sones	CFM	Sones	CFM	Sones	CFM	Sones	CFM	Sones	CFM	Sones	CFM	Sones	CFM	Sones
FX16V	1/6	485	1050	3788	1604	7.9	1358	6.5	1128	5.5	951	5.8	801	6.3	705	6.9	644	7.7	522	9.2	384	9.3	230	9.7
FX16S	1/3	527	1300	4690	1874	10.7	1693	9.5	1514	8.6	1326	8.0	1158	7.6	1023	7.7	913	8.2	735	9.6	572	9.7	379	9.9
FX16R	1/2	590	1550	5592	2140	12.8	1994	11.9	1849	11.0	1709	10.2	1561	9.9	1410	9.6	1269	9.4	1033	9.7	812	11.1	583	10.8
FX16Q1	1/2	715	1650	5953	2531	15.2	2432	14.7	2332	14.2	2232	13.7	2114	13.1	1992	12.5	1868	11.9	1582	11.0	1320	11.5	1001	12.1
FX16Q2	3/4	890	1725	6223	2822	17.1	2753	16.8	2684	16.5	2594	16.1	2501	15.7	2418	15.4	2331	15.1	2119	14.2	1872	14.1	1566	14.2

See notes at bottom of page.

› **FX18 Direct Drive Fan Dimensional Data**

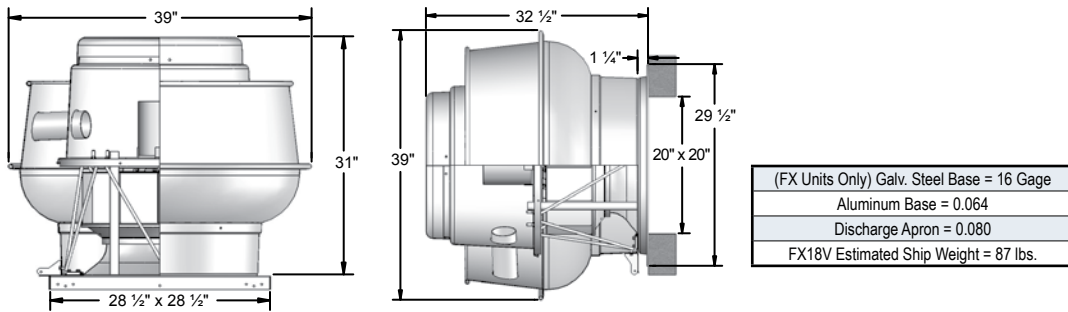

› **FX18 Direct Drive Performance Data**

Model	Nominal			Tip Speed FPM	0.000" SP		0.125" SP		0.250" SP		0.375" SP		0.500" SP		0.625" SP		0.750" SP		1.000" SP		1.250" SP		1.500" SP	
	HP	Max Watts	RPM		CFM	Sones	CFM	Sones	CFM	Sones	CFM	Sones	CFM	Sones	CFM	Sones	CFM	Sones	CFM	Sones	CFM	Sones	CFM	Sones
FX18V	3/4	969	1075	6029	4489	21.0	4333	21.0	4177	20.0	4011	19.1	3831	18.1	3652	17.6	3455	17.2	3023	16.5	2431	17.5	1447	20.0

Performance shown is for installation Type A: Free Inlet, Free Outlet. Speed (RPM) shown is nominal. Performance is based on actual speed of test. The sound ratings shown are for loudness values in fan sones at 5'0" (1.5m) in a hemispherical free field per AMCA Standard 301. Values shown are for Installation Type A: Free Inlet Fan Sone Levels. Performance ratings do not include the effects of appurtenances in the air stream.

Fumex fans are only one component of a total system. As such, fan performance is directly affected by the system. It is critical that system designers determine the actual system loss to ensure that the actual flow is specified in the system design.

Performance Data

Fumex | Direct Drive



Centrifugal Fans

Fan Curves

> Fan Curves

The fan curves illustrated here show the range of capacities available for direct drive units. Each graph shows the performance of several models at one particular nominal speed. Fan curves provide a quick method for selecting a fan unit based on design point requirements.

The direct drive performance charts on the previous pages provides the tabular data (CFM and static pressure) used to plot the fan curves. In addition, the horsepower tip speed and sones are tabulated. Since sound is normally an important factor in the selection of a fan, an engineer will usually want to select the "slowest" unit which meets CFM and SP requirements.

Please refer to the Motor Availability section to make sure the motor you select meets your electrical requirements.

> Nominal 1075 RPM

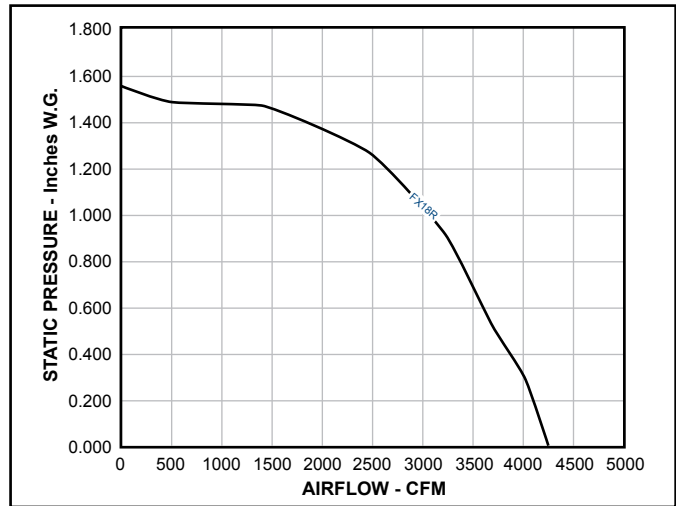

> Nominal 1050 RPM

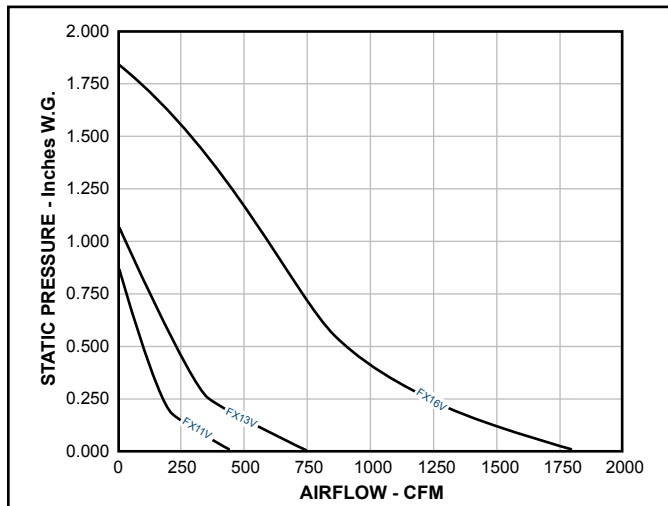

> Nominal 1550 RPM

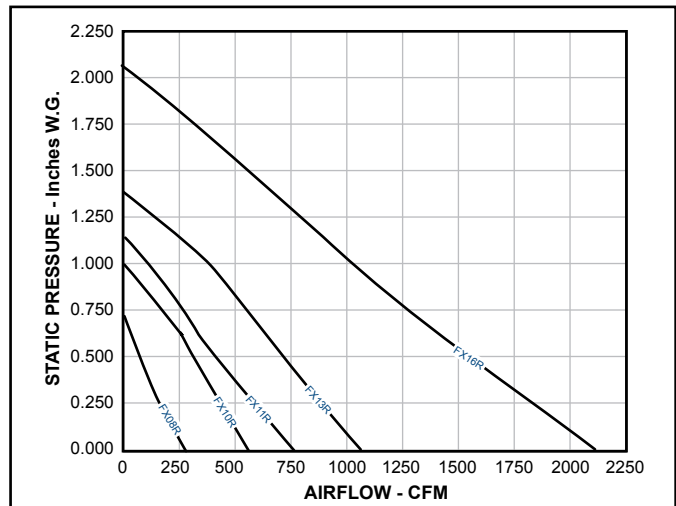

> Nominal 1300 RPM

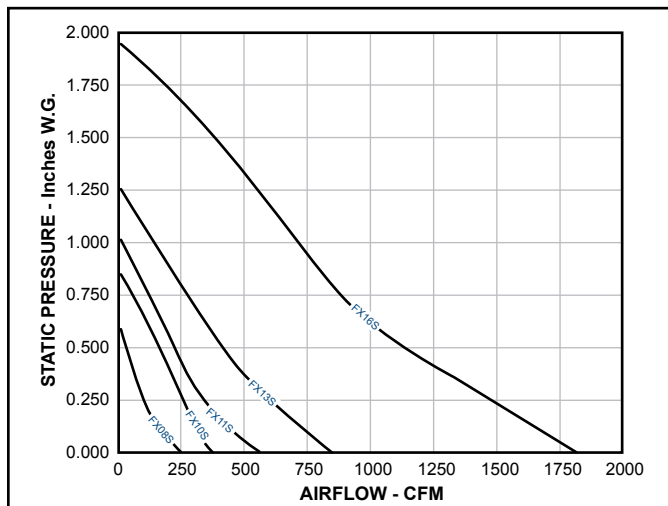

> Nominal 1725 RPM

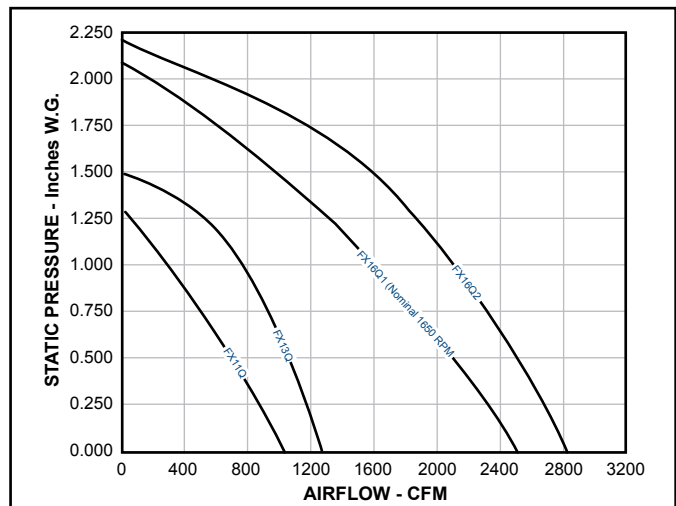

Fumex fans are only one component of a total system. As such, fan performance is directly affected by the system. It is critical that system designers determine the actual system loss to ensure that the actual flow is specified in the system design. Performance shown is for installation Type A: Free Inlet, Free Outlet. Speed (RPM) shown is nominal. Performance is based on actual speed of test. Performance ratings do not include the effects of appurtenances in the air stream.

©PENNBARRY 2019

Performance Data & Belt Drive Losses

› Performance Data

The belt drive models shown on the following pages have sizes and capacities ranging from below 250 CFM to above 30,000 CFM, with static pressures from 0" to 4". All models are available with a wide range of horsepower sizes and RPM's. Two-speed motors are commonly used to enhance this flexibility.

The data provided for each belt drive model includes:

- Elevation Drawing Showing Overall Dimensions
- Fan Curve Graph
- Performance Chart

Each curve graphically displays the range of capacities available for each model, in most cases beyond the specifics shown in the tabular data. The maximum performance afforded by each horsepower is indicated by dashed lines and the RPM is indicated by solid lines.

Some models have graphs that show both shaded and unshaded areas. Selection should be made from the unshaded area only. Shaded areas reflect unstable performance ("surge"), a characteristic typical of backward inclined wheels, and should be avoided. These unstable regions are not shown in the tabular data.

The highest RPM shown for a specific horsepower in the tabular data is the maximum speed that for any point along the performance curve, the BHP will not exceed the available horsepower.

It is important to note that while it is common industry-wide practice to exceed a "nominal" horsepower by using a motor's service factor, PennBarry uses a conservative portion of the service factor, allowing half to remain a true "safety" factor.

Use the Motor Availability chart (see Motor Selection) to select motor enclosures and voltages which can be installed in the fans.

Note: Fumex fans are only one component of a total system. As such, performance is directly affected by the system. It is critical that system designers determine actual system losses to ensure that the actual flow is specified in the system range.

› Belt Drive Losses

The AMCA Review Committee has developed the chart shown below for the purpose of estimating belt drive losses. To calculate total BHP (including drive losses): Find the BHP of your operating point on the x-axis on the graph below. Follow the vertical line to the curves indicating the range of drive losses. Look at the y-axis on the left and find the drive loss percentage. Calculate the total BHP by adding the drive loss to the operating point BHP. For BHP's below 0.3, use 30%.

› Drive Loss Reference Chart

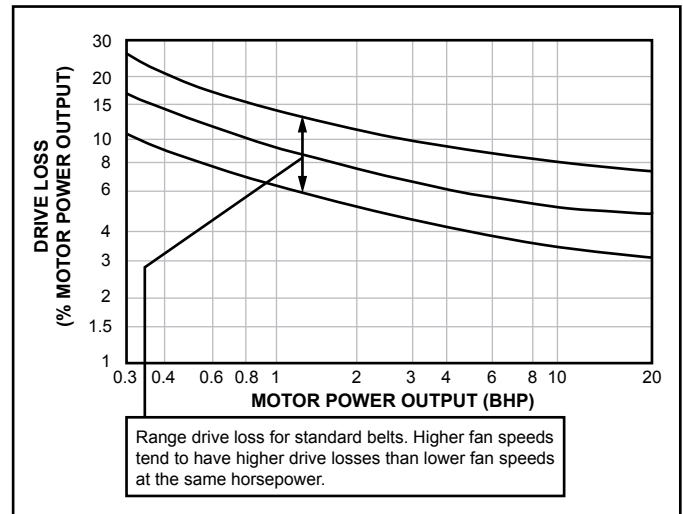

! For totally enclosed, explosion proof, multi-speed and all 1.0 Service Factor motors, fan BHP plus drive losses should not exceed motor rated HP.

Graph reprinted from AMCA publication 203, with the express written permission from the Air Movement and Control Association, Inc., 30 West University Drive, Arlington Heights, IL 60004-1983.

Dimensional Information & Performance Data

Fumex | Belt Drive



FX08B

Centrifugal Fans

FX08B Belt Drive Fan Curves

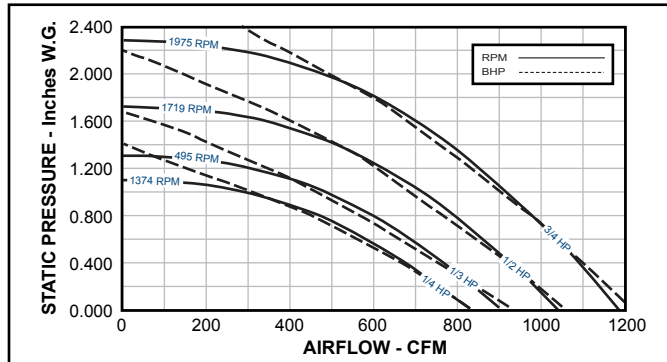

FX08B Belt Drive Fan Dimensional Data

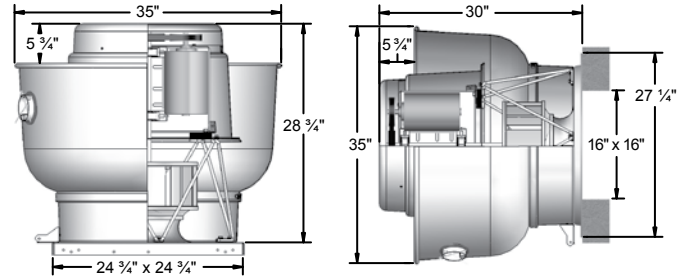

Galv. Steel Base = 16 Gage	Roof/Wall Opening = 16" SQ.	Peak BHP = (RPM/2126) ³
Aluminum Base = 0.064	Damper Size = 15 1/4" SQ.	Max. RPM = 2085 (1 HP)
Discharge Apron = 0.064	Max. Motor Frame Size = 55	Est. Ship Weight = 96 lbs.*

* Add 8 lbs. for Heat & Smoke option.

FX08B Belt Drive Fan Performance Data

HP	RPM	Tip Speed FPM	0.000" SP		0.125" SP		0.250" SP		0.375" SP		0.500" SP		0.625" SP		0.750" SP		0.875" SP		1.000" SP		1.125" SP	
			Sones	BHP	Sones	BHP	Sones	BHP	Sones	BHP	Sones	BHP	Sones	BHP	Sones	BHP	Sones	BHP	Sones	BHP	Sones	BHP
1/4	350	1191	208	-	-	-	-	-	-	-	-	-	-	-	-	-	-	-	-	-	-	-
			1.7	0.01	-	-	-	-	-	-	-	-	-	-	-	-	-	-	-	-	-	-
	525	1787	312	-	-	-	-	-	-	-	-	-	-	-	-	-	-	-	-	-	-	-
			4.2	0.01	4.2	0.01	-	-	-	-	-	-	-	-	-	-	-	-	-	-	-	-
	700	2382	416	-	320	-	163	-	-	-	-	-	-	-	-	-	-	-	-	-	-	-
			4.5	0.03	4.4	0.03	4.2	0.03	-	-	-	-	-	-	-	-	-	-	-	-	-	-
	875	2978	520	-	447	-	359	-	231	-	-	-	-	-	-	-	-	-	-	-	-	-
			5.9	0.06	5.8	0.07	5.6	0.07	5.3	0.07	-	-	-	-	-	-	-	-	-	-	-	-
1050	3574	624	-	563	-	497	-	422	-	324	-	108	-	-	-	-	-	-	-	-	-	
		8.0	0.11	7.9	0.11	7.6	0.12	7.3	0.12	6.9	0.12	6.0	0.10	-	-	-	-	-	-	-	-	-
1225	4169	728	-	677	-	623	-	564	-	498	-	421	-	306	-	-	-	-	-	-	-	
		10.6	0.17	10.4	0.18	10.2	0.18	9.8	0.18	9.4	0.19	9.0	0.19	8.3	0.18	-	-	-	-	-	-	-
1374	4676	817	-	771	-	724	-	674	-	619	-	560	-	493	-	407	-	275	-	-	-	
		12.1	0.25	11.9	0.25	11.6	0.25	11.3	0.26	11.0	0.26	10.7	0.27	10.3	0.26	9.9	0.26	9.2	0.24	-	-	-
1/3	1410	4799	838	-	793	-	748	-	700	-	647	-	591	-	528	-	455	-	346	-	152	
			12.6	0.27	12.3	0.27	12.1	0.27	11.8	0.27	11.4	0.28	11.1	0.29	10.8	0.29	10.4	0.28	9.9	0.27	9.0	0.23
	1440	4901	856	-	812	-	767	-	722	-	670	-	616	-	557	-	489	-	394	-	252	
			13.0	0.28	12.7	0.29	12.5	0.29	12.2	0.29	11.8	0.30	11.5	0.30	11.2	0.31	10.9	0.30	10.4	0.29	9.7	0.27
1470	5003	874	-	831	-	787	-	743	-	693	-	640	-	584	-	519	-	437	-	318		
		13.4	0.30	13.2	0.31	12.9	0.31	12.6	0.31	12.3	0.32	11.9	0.32	11.6	0.33	11.3	0.32	11.0	0.31	10.3	0.30	
1495	5088	889	-	846	-	804	-	760	-	711	-	660	-	605	-	543	-	472	-	366		
		13.8	0.32	13.5	0.32	13.3	0.33	13.0	0.33	12.7	0.33	12.3	0.34	11.9	0.34	11.6	0.34	11.4	0.33	10.9	0.32	
1/2	1535	5224	912	-	871	-	830	-	787	-	741	-	692	-	639	-	582	-	518	-	429	
			14.3	0.34	14.0	0.35	13.8	0.35	13.5	0.35	13.2	0.36	12.9	0.37	12.5	0.37	12.1	0.37	11.8	0.37	11.5	0.35
	1565	5326	930	-	890	-	849	-	807	-	763	-	715	-	664	-	611	-	548	-	472	
			14.6	0.36	14.4	0.37	14.1	0.37	13.8	0.37	13.5	0.38	13.2	0.39	12.8	0.39	12.5	0.39	12.1	0.39	11.9	0.38
	1595	5428	948	-	909	-	869	-	828	-	785	-	738	-	689	-	637	-	578	-	511	
			14.9	0.39	14.0	0.39	14.5	0.40	14.2	0.40	13.9	0.40	13.5	0.41	13.2	0.41	12.9	0.42	12.5	0.41	12.3	0.41
	1630	5548	969	-	930	-	891	-	851	-	810	-	764	-	717	-	667	-	612	-	551	
			15.4	0.41	15.1	0.42	14.9	0.42	14.6	0.42	14.3	0.42	14.0	0.43	13.6	0.44	13.3	0.44	13.0	0.44	12.7	0.44
1665	5667	990	-	952	-	914	-	875	-	835	-	790	-	745	-	696	-	646	-	587		
		15.8	0.44	1.6	0.44	15.3	0.45	15.1	0.45	14.8	0.45	14.5	0.46	14.1	0.47	13.8	0.47	13.5	0.48	13.1	0.47	
1695	5769	1008	-	970	-	933	-	895	-	856	-	813	-	768	-	721	-	672	-	616		
		16.2	0.46	1.0	0.47	15.7	0.47	15.5	0.48	15.2	0.48	14.9	0.48	14.6	0.49	14.2	0.50	13.9	0.50	13.6	0.50	
1719	5850	1022	-	985	-	948	-	911	-	872	-	830	-	787	-	741	-	693	-	640		
		16.6	0.48	16.4	0.49	16.1	0.49	15.9	0.50	15.6	0.50	15.2	0.50	14.9	0.51	14.6	0.52	14.3	0.52	13.9	0.52	
3/4	1755	5973	1043	-	1007	-	971	-	934	-	897	-	857	-	814	-	770	-	723	-	674	
			17.1	0.51	16.9	0.52	16.7	0.52	16.4	0.53	16.2	0.53	15.8	0.53	15.5	0.54	15.2	0.55	14.8	0.55	14.5	0.56
	1795	6109	1067	-	1032	-	997	-	961	-	924	-	886	-	844	-	802	-	757	-	711	
			17.7	0.55	17.5	0.56	17.3	0.56	17.0	0.56	16.8	0.56	16.5	0.57	16.2	0.58	15.8	0.58	15.5	0.59	15.2	0.59
	1830	6228	1088	-	1053	-	1019	-	984	-	948	-	911	-	870	-	829	-	786	-	741	
			18.3	0.58	18.1	0.59	17.8	0.59	17.6	0.60	17.4	0.60	17.1	0.60	16.8	0.61	16.5	0.62	16.2	0.62	15.9	0.63
	1860	6330	1106	-	1072	-	1038	-	1003	-	968	-	933	-	893	-	853	-	810	-	766	
			18.8	0.61	18.6	0.62	18.4	0.62	18.1	0.63	17.9	0.63	17.6	0.63	17.3	0.64	17.0	0.65	16.7	0.66	16.4	0.66
	1890	6432	1124	-	1090	-	1057	-	1023	-	988	-	953	-	915	-	875	-	834	-	791	
			19.4	0.64	19.1	0.65	18.9	0.65	18.6	0.66	18.4	0.66	18.1	0.66	17.8	0.67	17.5	0.68	17.2	0.68	17.0	0.69
1920	6535	1141	-	1109	-	1076	-	1042	-	1008	-	974	-	937	-	898	-	858	-	816		
		19.8	0.67	19.6	0.68	19.4	0.68	19.1	0.69	18.9	0.69	18.6	0.69	18.3	0.70	18.0	0.71	17.7	0.72	17.4	0.72	
1950	6637	1159	-	1127	-	1095	-	1062	-	1028	-	995	-	959	-	920	-	882	-	841		
		20	0.70	20	0.71	19.8	0.72	19.6	0.72	19.3	0.72	19.1	0.72	18.8	0.73	18.5	0.74	18.2	0.75	17.9	0.75	
1975	6722	1174	-	1142	-	1110	-	1078	-	1045	-	1012	-	977	-	939	-	901	-	861		
		21	0.73	20	0.74	20	0.74	20	0.75	19.7	0.75	19.5	0.75	19.1	0.76	18.8	0.77	18.6	0.78	18.3	0.78	

Performance shown is for installation type A: Free Inlet, Free Outlet. Power rating (BHP) does not include drive losses. For further information on estimating belt drive losses and motor service factors see page 11. The sound ratings shown are for loudness values in fan sones at 5'0" (1.5m) in a hemispherical free field per AMCA Standard 301. Values shown are for installation Type A: free inlet sone levels. Performance ratings do not include the effects of appurtenances in the airstream.

©PENN BARRY 2019

FUMEX

► **FX10B Belt Drive Fan Curves**

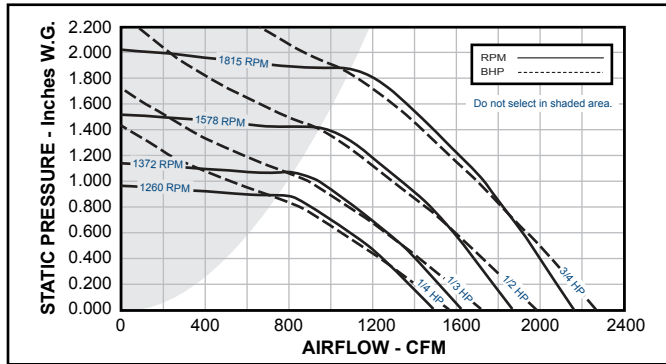

► **FX10B Belt Drive Fan Dimensional Data**

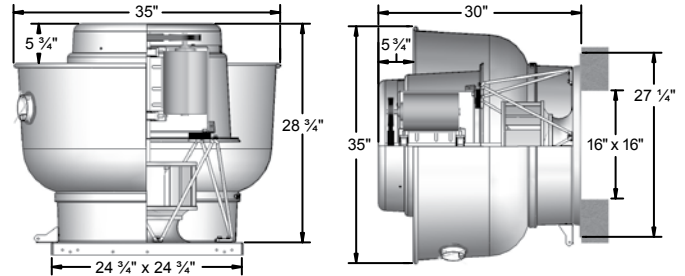

Galv. Steel Base = 16 Gage	Roof/Wall Opening = 16" SQ.	Peak BHP = (RPM/1869) ³
Aluminum Base = 0.064	Damper Size = 15 1/2" SQ.	Max. RPM = 2085 (1 1/2 HP)
Discharge Apron = 0.064	Max. Motor Frame Size = 56	Est. Ship Weight = 96 lbs.*

* Add 8 lbs. for Heat & Smoke option.

► **FX10B Belt Drive Fan Performance Data**

HP	RPM	Tip Speed FPM	0.000" SP		0.125" SP		0.250" SP		0.375" SP		0.500" SP		0.625" SP		0.750" SP		1.000" SP		1.125" SP		1.250" SP			
			Sones	BHP	Sones	BHP	Sones	BHP	Sones	BHP	Sones	BHP	Sones	BHP	Sones	BHP	Sones	BHP	Sones	BHP	Sones	BHP	Sones	BHP
1/4	600	2042	714	543	-	-	-	-	-	-	-	-	-	-	-	-	-	-	-	-	-	-	-	
	750	2553	892	765	596	-	-	-	-	-	-	-	-	-	-	-	-	-	-	-	-	-	-	
			6.7 0.05	6.6 0.05	6.5 0.06	-	-	-	-	-	-	-	-	-	-	-	-	-	-	-	-	-	-	-
	900	3063	1071	968	854	696	-	-	-	-	-	-	-	-	-	-	-	-	-	-	-	-	-	-
			7.3 0.08	7.1 0.09	7.1 0.10	-	-	-	-	-	-	-	-	-	-	-	-	-	-	-	-	-	-	-
	1000	3403	1190	1097	998	874	730	-	-	-	-	-	-	-	-	-	-	-	-	-	-	-	-	-
8.6 0.11			8.4 0.12	8.3 0.13	8.3 0.13	0.31 0.13	-	-	-	-	-	-	-	-	-	-	-	-	-	-	-	-	-	-
1100	3744	1309	1225	1136	1042	915	780	-	-	-	-	-	-	-	-	-	-	-	-	-	-	-	-	
		10.4 0.14	10.2 0.15	10.0 0.16	9.9 0.17	9.9 0.18	9.9 0.18	9.9 0.18	-	-	-	-	-	-	-	-	-	-	-	-	-	-	-	-
1260	4288	1499	1426	1352	1271	1187	1076	961	-	-	-	-	-	-	-	-	-	-	-	-	-	-	-	
		13.5 0.22	13.2 0.23	13.0 0.24	12.7 0.25	12.6 0.26	12.6 0.26	12.6 0.26	12.6 0.26	-	-	-	-	-	-	-	-	-	-	-	-	-	-	-
1/3	1300	4424	1547	1476	1404	1327	1249	1144	1035	-	-	-	-	-	-	-	-	-	-	-	-	-	-	
	1325	4509	1577	1507	1437	1361	1285	1187	1080	-	-	-	-	-	-	-	-	-	-	-	-	-	-	
			14.2 0.25	13.9 0.26	13.7 0.28	13.4 0.29	13.2 0.30	13.1 0.30	13.1 0.31	-	-	-	-	-	-	-	-	-	-	-	-	-	-	-
	1350	4595	1607	1538	1469	1396	1320	1229	1125	892	-	-	-	-	-	-	-	-	-	-	-	-	-	-
			14.4 0.27	14.2 0.28	13.9 0.29	13.7 0.30	13.4 0.31	13.4 0.32	13.3 0.32	13.3 0.32	13.3 0.32	-	-	-	-	-	-	-	-	-	-	-	-	-
1372	4669	1633	1565	1497	1426	1352	1266	1164	943	-	-	-	-	-	-	-	-	-	-	-	-	-	-	
		14.7 0.28	14.5 0.29	14.2 0.31	13.9 0.32	13.7 0.33	13.6 0.33	13.5 0.34	13.5 0.34	13.5 0.34	-	-	-	-	-	-	-	-	-	-	-	-	-	
1/2	1390	4731	1654	1587	1521	1450	1377	1296	1195	984	-	-	-	-	-	-	-	-	-	-	-	-	-	
	1420	4833	1690	1624	1559	1491	1419	1345	1247	1044	909	-	-	-	-	-	-	-	-	-	-	-	-	
			15.4 0.31	15.2 0.32	14.9 0.34	14.6 0.35	14.3 0.36	14.1 0.37	13.9 0.37	13.9 0.38	13.9 0.38	13.9 0.38	-	-	-	-	-	-	-	-	-	-	-	
	1450	4935	1726	1662	1597	1531	1461	1391	1298	1100	988	-	-	-	-	-	-	-	-	-	-	-	-	
			15.9 0.33	15.7 0.34	15.4 0.36	15.1 0.37	14.8 0.38	14.6 0.39	14.4 0.40	14.3 0.40	14.3 0.40	14.3 0.40	-	-	-	-	-	-	-	-	-	-	-	
	1475	5020	1755	1692	1629	1565	1496	1427	1340	1147	1045	-	-	-	-	-	-	-	-	-	-	-	-	
			16.3 0.35	16.1 0.36	15.9 0.38	15.6 0.39	15.3 0.40	15.0 0.41	14.8 0.42	14.6 0.42	14.6 0.42	14.6 0.42	-	-	-	-	-	-	-	-	-	-	-	
	1500	5105	1785	1723	1661	1599	1531	1463	1382	1193	1096	968	-	-	-	-	-	-	-	-	-	-	-	
			16.7 0.36	16.5 0.38	16.3 0.39	16.0 0.41	15.7 0.42	15.4 0.43	15.1 0.44	14.9 0.44	14.9 0.44	14.9 0.44	14.9 0.44	-	-	-	-	-	-	-	-	-	-	
	1525	5190	1815	1754	1693	1632	1565	1498	1423	1239	1143	1034	-	-	-	-	-	-	-	-	-	-	-	
17.0 0.38			16.8 0.40	16.6 0.41	16.3 0.43	15.9 0.44	15.6 0.45	15.3 0.46	15.0 0.47	15.0 0.47	15.0 0.47	15.0 0.47	-	-	-	-	-	-	-	-	-	-		
1550	5275	1845	1785	1725	1665	1600	1534	1465	1284	1190	1091	-	-	-	-	-	-	-	-	-	-	-		
		17.2 0.40	17.0 0.42	16.8 0.43	16.5 0.45	16.2 0.46	15.8 0.47	15.6 0.48	15.1 0.49	15.1 0.49	15.1 0.49	15.1 0.49	-	-	-	-	-	-	-	-	-	-		
1578	5371	1878	1819	1760	1701	1638	1573	1509	1333	1241	1149	-	-	-	-	-	-	-	-	-	-	-		
		17.4 0.42	17.2 0.44	17.0 0.46	16.8 0.47	16.4 0.48	16.1 0.49	15.8 0.51	15.3 0.52	15.3 0.52	15.3 0.52	15.3 0.52	-	-	-	-	-	-	-	-	-	-		
3/4	1600	5445	1904	1846	1788	1730	1668	1604	1541	1371	1282	1191	-	-	-	-	-	-	-	-	-	-		
	1630	5548	1940	1883	1826	1769	1709	1646	1584	1423	1336	1247	-	-	-	-	-	-	-	-	-	-		
			17.8 0.47	17.6 0.48	17.4 0.50	17.2 0.52	16.9 0.53	16.6 0.54	16.2 0.55	15.5 0.57	15.5 0.57	15.5 0.57	15.5 0.57	-	-	-	-	-	-	-	-	-		
	1660	5650	1976	1920	1864	1808	1749	1688	1627	1474	1390	1302	-	-	-	-	-	-	-	-	-	-		
			18.0 0.49	17.9 0.51	17.7 0.53	17.5 0.54	17.2 0.56	16.9 0.57	16.5 0.58	15.8 0.60	15.8 0.60	15.8 0.60	15.8 0.60	-	-	-	-	-	-	-	-			
	1695	5769	2017	1962	1908	1853	1796	1736	1676	1534	1451	1367	-	-	-	-	-	-	-	-	-	-		
			18.4 0.53	18.2 0.54	18.1 0.56	17.9 0.58	17.6 0.59	17.3 0.60	16.9 0.62	16.2 0.63	16.2 0.63	16.2 0.63	16.2 0.63	-	-	-	-	-	-	-	-			
	1730	5888	2059	2005	1952	1898	1843	1784	1726	1592	1511	1430	-	-	-	-	-	-	-	-	-	-		
			18.8 0.56	18.6 0.58	18.5 0.59	18.3 0.61	18.0 0.63	17.7 0.64	17.4 0.65	16.7 0.67	16.7 0.67	16.7 0.67	16.7 0.67	-	-	-	-	-	-	-	-			
	1765	6007	2101	2048	1995	1943	1890	1832	1775	1650	1571	1492	-	-	-	-	-	-	-	-	-	-		
19.3 0.59			19.2 0.61	19.0 0.63	18.9 0.65	18.6 0.66	18.3 0.68	18.0 0.69	17.3 0.71	17.3 0.71	17.3 0.71	17.3 0.71	-	-	-	-	-	-	-	-				
1790	6092	2130	2078	2027	1975	1923	1866	1810	1692	1613	1535	-	-	-	-	-	-	-	-	-	-			
		19.8 0.62	19.6 0.64	19.5 0.66	19.4 0.67	19.0 0.69	18.7 0.70	18.4 0.72	17.7 0.74	17.7 0.74	17.7 0.74	17.7 0.74	-	-	-	-	-	-	-	-				
1815	6177	2160	2109	2058	2007	1955	1900	1844	1732	1655	1578	-	-	-	-	-	-	-	-	-				
		20.0 0.65	20.0 0.66	20.0 0.68	19.9 0.70	19.6 0.72	19.2 0.73	18.9 0.75	18.2 0.77	18.2 0.77	18.2 0.77	18.2 0.77	-	-	-	-	-	-	-					

Performance shown is for installation type A: Free Inlet, Free Outlet. Power rating (BHP) does not include drive losses. For further information on estimating belt drive losses and motor service factors see page 11. The sound ratings shown are for loudness values in fan sones at 50' (1.5m) in a hemispherical free field per AMCA Standard 301. Values shown are for installation Type A: free inlet sone levels. Performance ratings do not include the effects of appurtenances in the airstream.

Dimensional Information & Performance Data

Fumex | Belt Drive



FX12BH

Centrifugal Fans

FX12BH Belt Drive Fan Curves

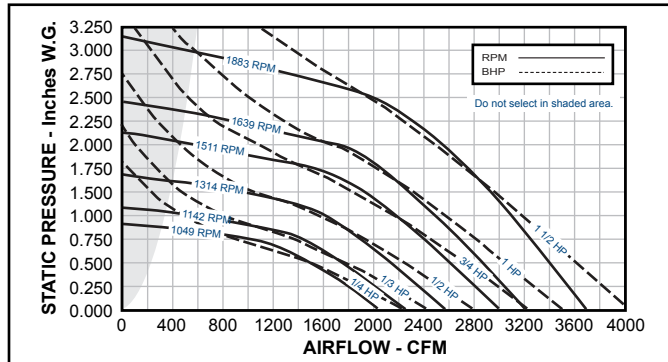

FX12BH Belt Drive Fan Dimensional Data

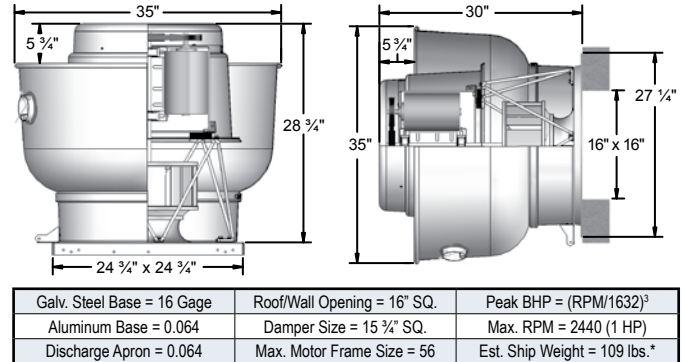

* Add 8 lbs. for Heat & Smoke option.

FX12BH Belt Drive Fan Performance Data

HP	RPM	Tip Speed FPM	0.250" SP		0.500" SP		0.750" SP		1.000" SP		1.250" SP		1.500" SP		1.750" SP		2.000" SP		2.250" SP		2.500" SP			
			Sones	BHP	Sones	BHP	Sones	BHP	Sones	BHP	Sones	BHP	Sones	BHP	Sones	BHP	Sones	BHP	Sones	BHP	Sones	BHP	Sones	BHP
1/4	840	3491	7.4	0.13	7.0	0.13	-	-	-	-	-	-	-	-	-	-	-	-	-	-	-	-	-	
	880	3657	8.4	0.14	7.7	0.16	-	-	-	-	-	-	-	-	-	-	-	-	-	-	-	-	-	
	920	3824	9.0	0.16	8.4	0.18	-	-	-	-	-	-	-	-	-	-	-	-	-	-	-	-	-	
	970	4031	9.2	0.19	8.8	0.21	9.1	0.16	-	-	-	-	-	-	-	-	-	-	-	-	-	-	-	
	1049	4360	10.1	0.23	9.8	0.26	10.0	0.26	-	-	-	-	-	-	-	-	-	-	-	-	-	-	-	
	1105	4592	10.8	0.27	10.6	0.29	10.6	0.31	10.9	0.22	-	-	-	-	-	-	-	-	-	-	-	-	-	
1/3	1142	4746	11.1	0.29	10.9	0.32	11.0	0.34	11.3	0.29	-	-	-	-	-	-	-	-	-	-	-	-	-	
	1175	4883	11.5	0.32	11.2	0.35	11.2	0.37	11.7	0.35	-	-	-	-	-	-	-	-	-	-	-	-	-	
	1200	4987	11.8	0.34	11.6	0.37	11.4	0.39	12.0	0.39	-	-	-	-	-	-	-	-	-	-	-	-	-	
	1235	5133	12.1	0.37	12.1	0.40	11.8	0.42	12.4	0.43	12.5	0.31	-	-	-	-	-	-	-	-	-	-	-	
	1280	5320	12.4	0.40	12.7	0.44	12.4	0.46	12.7	0.48	13.1	0.42	-	-	-	-	-	-	-	-	-	-	-	
	1314	5461	12.6	0.43	13.1	0.47	12.9	0.50	13.1	0.52	13.6	0.49	-	-	-	-	-	-	-	-	-	-	-	
3/4	1340	5569	12.8	0.46	13.4	0.50	13.3	0.53	13.4	0.55	14.1	0.54	14.0	0.36	-	-	-	-	-	-	-	-	-	
	1375	5715	13.1	0.49	13.8	0.53	13.8	0.57	13.8	0.59	14.6	0.59	14.6	0.48	-	-	-	-	-	-	-	-	-	
	1400	5818	13.2	0.52	14.1	0.56	14.1	0.59	14.2	0.62	14.7	0.63	15.0	0.54	-	-	-	-	-	-	-	-	-	
	1435	5964	13.5	0.56	14.5	0.60	14.6	0.64	14.7	0.66	15.7	0.63	-	-	-	-	-	-	-	-	-	-	-	
	1462	6076	13.9	0.59	14.9	0.63	15.0	0.67	15.1	0.69	16.2	0.69	16.2	0.69	16.1	0.51	-	-	-	-	-	-	-	
	1511	6280	14.7	0.65	15.7	0.69	16.0	0.73	16.0	0.76	17.0	0.79	17.0	0.79	17.0	0.68	-	-	-	-	-	-	-	
1	1540	6400	15.0	0.68	15.9	0.73	16.3	0.77	16.3	0.80	17.2	0.82	17.2	0.83	17.6	0.76	-	-	-	-	-	-	-	
	1586	6592	15.5	0.74	16.3	0.79	16.7	0.83	16.8	0.87	17.4	0.91	17.4	0.91	18.4	0.89	18.3	0.73	-	-	-	-	-	
	1600	6650	15.7	0.76	16.4	0.81	16.9	0.85	16.9	0.89	17.1	0.92	17.6	0.93	18.6	0.93	18.5	0.78	-	-	-	-	-	
	1639	6812	16.2	0.81	16.8	0.87	17.3	0.91	17.3	0.95	17.9	0.98	17.9	1.00	18.9	1.00	19.1	0.91	-	-	-	-	-	
	1675	6961	16.7	0.87	17.3	0.92	17.8	0.97	17.8	1.01	17.9	1.04	18.2	1.06	19.0	1.07	19.7	1.02	19.6	0.84	-	-	-	
	1750	7273	18.0	0.98	18.4	1.04	18.8	1.09	18.8	1.14	18.8	1.17	18.8	1.20	19.5	1.22	21.0	1.22	21.0	1.13	21.0	1.13	21.0	0.89
1 1/2	1825	7585	19.4	1.11	19.7	1.17	19.9	1.22	19.9	1.27	19.8	1.31	19.8	1.34	20.0	1.37	21.0	1.38	22.0	1.38	22.0	1.38	22.0	1.24
	1883	7826	21.0	1.22	21.0	1.28	21.0	1.33	21.0	1.38	21.0	1.43	21.0	1.46	21.0	1.49	21.0	1.51	22.0	1.53	23.0	1.53	23.0	1.47

Performance shown is for installation type A: Free Inlet, Free Outlet. Power rating (BHP) does not include drive losses. For further information on estimating belt drive losses and motor service factors see page 11. The sound ratings shown are for loudness values in fan sones at 5'0" (1.5m) in a hemispherical free field per AMCA Standard 301. Values shown are for installation Type A: free inlet sone levels. Performance ratings do not include the effects of appurtenances in the airstream.

► FX13B Belt Drive Fan Curves

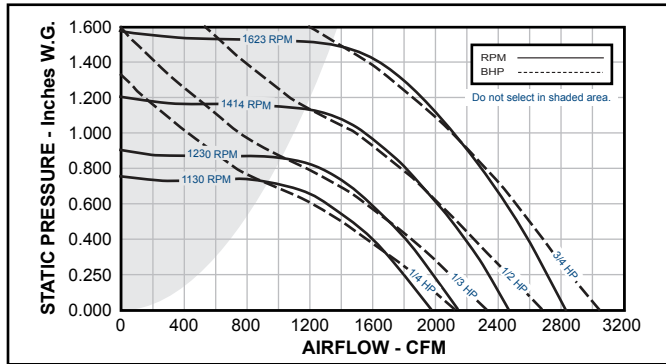

► FX13B Belt Drive Fan Dimensional Data

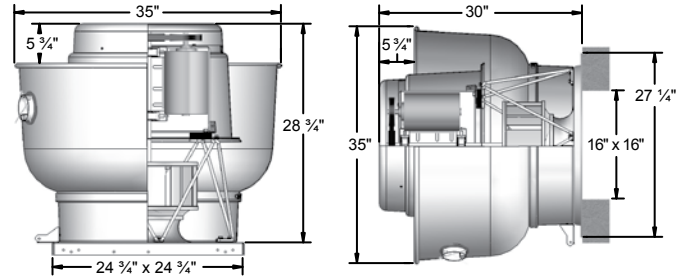

Galv. Steel Base = 16 Gage	Roof/Wall Opening = 16" SQ.	Peak BHP = (RPM/1751) ³
Aluminum Base = 0.064	Damper Size = 15 1/2" SQ.	Max. RPM = 2202 (1 1/2 HP)
Discharge Apron = 0.064	Max. Motor Frame Size = 56	Est. Ship Weight = 110 lbs.*

* Add 8 lbs. for Heat & Smoke option.

► FX13B Belt Drive Fan Performance Data

HP	RPM	Tip Speed FPM	0.000" SP		0.250" SP		0.375" SP		0.500" SP		0.625" SP		0.750" SP		0.875" SP		1.000" SP		1.250" SP		1.375" SP			
			Sones	BHP	Sones	BHP	Sones	BHP	Sones	BHP	Sones	BHP	Sones	BHP	Sones	BHP	Sones	BHP	Sones	BHP	Sones	BHP	Sones	BHP
1/4	500	1800	874	-	-	-	-	-	-	-	-	-	-	-	-	-	-	-	-	-	-	-	-	
	650	2340	1137	-	-	-	-	-	-	-	-	-	-	-	-	-	-	-	-	-	-	-	-	
	800	2880	1399	1052	-	-	-	-	-	-	-	-	-	-	-	-	-	-	-	-	-	-	-	
	978	3521	1710	1452	1284	1026	-	-	-	-	-	-	-	-	-	-	-	-	-	-	-	-	-	
	1055	3798	1845	1608	1471	1281	928	-	-	-	-	-	-	-	-	-	-	-	-	-	-	-	-	
	1130	4068	1976	1755	1635	1485	1281	-	-	-	-	-	-	-	-	-	-	-	-	-	-	-	-	
1/3	1160	4176	2029	1814	1699	1559	1377	1054	-	-	-	-	-	-	-	-	-	-	-	-	-	-	-	
	1185	4266	2072	1862	1751	1619	1448	1196	-	-	-	-	-	-	-	-	-	-	-	-	-	-	-	
	1210	4356	2116	1911	1804	1679	1519	1303	-	-	-	-	-	-	-	-	-	-	-	-	-	-	-	
	1230	4428	2151	1950	1845	1727	1574	1378	-	-	-	-	-	-	-	-	-	-	-	-	-	-	-	
1/2	1255	4518	2195	1998	1895	1782	1639	1458	1152	-	-	-	-	-	-	-	-	-	-	-	-	-	-	
	1280	4608	2239	2046	1945	1835	1701	1535	1292	-	-	-	-	-	-	-	-	-	-	-	-	-	-	
	1305	4698	2282	2094	1994	1889	1762	1606	1401	-	-	-	-	-	-	-	-	-	-	-	-	-	-	
	1330	4788	2326	2142	2044	1942	1823	1676	1493	1130	-	-	-	-	-	-	-	-	-	-	-	-	-	
	1355	4878	2370	2190	2093	1995	1883	1746	1573	1314	-	-	-	-	-	-	-	-	-	-	-	-	-	
	1375	4950	2405	2228	2132	2037	1931	1796	1636	1413	-	-	-	-	-	-	-	-	-	-	-	-	-	
	1400	5040	2449	2275	2181	2089	1985	1858	1708	1516	-	-	-	-	-	-	-	-	-	-	-	-	-	
	1414	5090	2473	2302	2208	2118	2015	1892	1747	1568	-	-	-	-	-	-	-	-	-	-	-	-	-	
	1445	5202	2527	2360	2269	2180	2082	1968	1834	1671	-	-	-	-	-	-	-	-	-	-	-	-	-	
	1470	5292	2571	2408	2317	2230	2135	2028	1903	1749	-	-	-	-	-	-	-	-	-	-	-	-	-	
3/4	1495	5382	2615	2455	2366	2280	2188	2088	1965	1821	1341	-	-	-	-	-	-	-	-	-	-	-	-	
	1525	5490	2667	2511	2424	2339	2251	2156	2039	1906	1521	-	-	-	-	-	-	-	-	-	-	-	-	
	1550	5580	2711	2558	2472	2388	2304	2210	2100	1975	1637	-	-	-	-	-	-	-	-	-	-	-	-	
	1575	5670	2755	2604	2520	2437	2356	2264	2160	2043	1731	1455	-	-	-	-	-	-	-	-	-	-	-	
	1600	5760	2798	2651	2568	2486	2406	2317	2220	2105	1818	1597	-	-	-	-	-	-	-	-	-	-	-	
	1623	5842	2839	2694	2612	2531	2452	2366	2275	2161	1892	1707	-	-	-	-	-	-	-	-	-	-	-	
	1623	5842	19.9	0.60	19.4	0.66	19.2	0.68	18.9	0.70	18.6	0.73	18.3	0.74	18.0	0.76	17.3	0.77	16.0	0.79	15.7	0.79	-	-

Performance shown is for installation type A: Free Inlet, Free Outlet. Power rating (BHP) does not include drive losses. For further information on estimating belt drive losses and motor service factors see page 11. The sound ratings shown are for loudness values in fan sones at 50' (1.5m) in a hemispherical free field per AMCA Standard 301. Values shown are for installation Type A: free inlet sone levels. Performance ratings do not include the effects of appurtenances in the airstream.

Dimensional Information & Performance Data

Fumex | Belt Drive



FX13BHFT

Centrifugal Fans

FX13BHFT Belt Drive Fan Curves

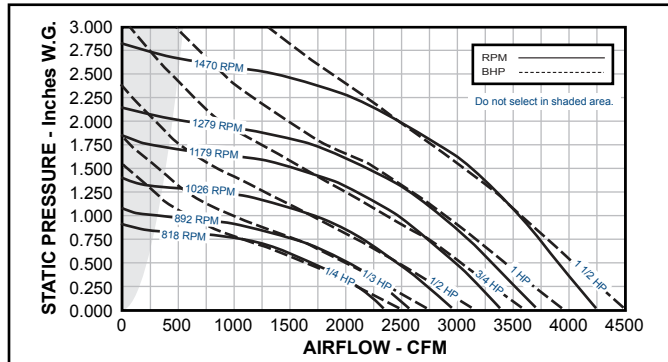

FX13BHFT Belt Drive Fan Dimensional Data

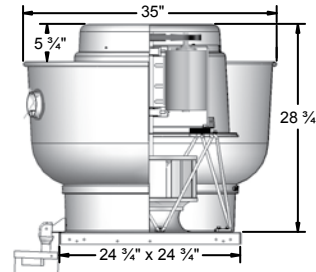

Galv. Steel Base = 16 Gage	Roof/Wall Opening = 16" SQ.	Peak BHP = (RPM/1277) ³
Aluminum Base = 0.064	Damper Size = 15 1/4" SQ.	Max. RPM = 1875 (1 1/2 HP)
Discharge Apron = 0.064	Max. Motor Frame Size = 56	Est. Ship Weight = 115 lbs.*

* Add 8 lbs. for Heat & Smoke option.

FX13BHFT Belt Drive Fan Performance Data

HP	RPM	Tip Speed FPM	0.250" SP		0.500" SP		0.750" SP		1.000" SP		1.250" SP		1.500" SP		1.750" SP		2.000" SP		2.250" SP		2.500" SP			
			Sones	BHP	Sones	BHP	Sones	BHP	Sones	BHP	Sones	BHP	Sones	BHP	Sones	BHP	Sones	BHP	Sones	BHP	Sones	BHP	Sones	BHP
1/4	750	3670	1817	1312	-	-	-	-	-	-	-	-	-	-	-	-	-	-	-	-	-	-	-	
	818	4002	2046	1645	915	-	-	-	-	-	-	-	-	-	-	-	-	-	-	-	-	-	-	
1/3	850	4159	2152	1781	1168	-	-	-	-	-	-	-	-	-	-	-	-	-	-	-	-	-	-	
	892	4365	2289	1953	1463	-	-	-	-	-	-	-	-	-	-	-	-	-	-	-	-	-	-	
1/2	925	4526	2395	2080	1641	782	-	-	-	-	-	-	-	-	-	-	-	-	-	-	-	-	-	
	950	4648	2476	2176	1769	1100	-	-	-	-	-	-	-	-	-	-	-	-	-	-	-	-	-	
			10.3	0.38	9.8	0.40	9.4	0.41	9.0	0.37	-	-	-	-	-	-	-	-	-	-	-	-	-	-
	975	4771	2554	2270	1888	1298	-	-	-	-	-	-	-	-	-	-	-	-	-	-	-	-	-	
1000	4893	2630	2360	2006	1483	-	-	-	-	-	-	-	-	-	-	-	-	-	-	-	-	-	-	
		11.3	0.44	10.6	0.46	10.1	0.48	9.8	0.46	-	-	-	-	-	-	-	-	-	-	-	-	-	-	-
1026	5020	2709	2451	2119	1666	739	-	-	-	-	-	-	-	-	-	-	-	-	-	-	-	-	-	
3/4	1050	5138	2782	2534	2218	1798	1104	-	-	-	-	-	-	-	-	-	-	-	-	-	-	-	-	
	1075	5260	2858	2619	2321	1932	1333	-	-	-	-	-	-	-	-	-	-	-	-	-	-	-	-	
			13.0	0.54	12.2	0.57	11.8	0.59	11.3	0.59	10.8	0.54	-	-	-	-	-	-	-	-	-	-	-	-
	1100	5382	2933	2705	2421	2057	1529	-	-	-	-	-	-	-	-	-	-	-	-	-	-	-	-	-
			13.6	0.57	12.8	0.60	12.5	0.63	12.0	0.63	11.3	0.60	-	-	-	-	-	-	-	-	-	-	-	-
	1125	5505	3008	2788	2518	2177	1708	828	-	-	-	-	-	-	-	-	-	-	-	-	-	-	-	-
14.2			0.61	13.4	0.64	13.1	0.67	12.6	0.68	12.0	0.66	11.1	0.51	-	-	-	-	-	-	-	-	-	-	
1150	5627	3083	2871	2613	2294	1881	1206	-	-	-	-	-	-	-	-	-	-	-	-	-	-	-	-	
		14.5	0.65	13.7	0.68	13.4	0.71	12.9	0.73	12.4	0.72	11.6	0.63	-	-	-	-	-	-	-	-	-	-	
1179	5769	3169	2967	2723	2422	2038	1471	-	-	-	-	-	-	-	-	-	-	-	-	-	-	-	-	
1	1200	5872	3232	3036	2802	2510	2150	1636	611	-	-	-	-	-	-	-	-	-	-	-	-	-	-	
	1225	5994	15.2	0.74	14.4	0.77	14.0	0.80	13.6	0.82	13.2	0.82	12.6	0.78	12.0	0.54	-	-	-	-	-	-	-	
			3306	3118	2891	2613	2277	1819	1054	-	-	-	-	-	-	-	-	-	-	-	-	-	-	
	1255	6141	15.6	0.79	14.8	0.82	14.2	0.85	13.9	0.87	13.5	0.88	13.1	0.85	12.5	0.70	-	-	-	-	-	-	-	-
3396			3216	2996	2736	2420	2029	1442	-	-	-	-	-	-	-	-	-	-	-	-	-	-	-	
1279	6258	3467	3294	3079	2830	2533	2165	1633	569	-	-	-	-	-	-	-	-	-	-	-	-	-	-	
		16.5	0.89	15.6	0.93	15.0	0.96	14.6	0.98	14.3	1.0	14.0	0.99	13.6	0.92	13.3	0.63	-	-	-	-	-	-	
1 1/2	1300	6361	3529	3362	3151	2911	2631	2278	1797	972	-	-	-	-	-	-	-	-	-	-	-	-	-	
	1325	6483	16.9	0.93	16.0	0.97	15.3	1.00	14.9	1.03	14.6	1.06	14.4	1.04	14.0	0.99	13.6	0.79	-	-	-	-	-	
			3603	3442	3237	3007	2737	2411	1978	1351	-	-	-	-	-	-	-	-	-	-	-	-	-	
	1360	6655	17.3	0.99	16.5	1.02	15.7	1.06	15.3	1.09	15.0	1.11	14.8	1.11	14.5	1.07	14.1	0.95	-	-	-	-	-	
			3706	3554	3355	3139	2882	2581	2222	1688	680	-	-	-	-	-	-	-	-	-	-	-	-	
	1400	6850	17.9	1.07	17.1	1.10	16.2	1.14	15.9	1.17	15.5	1.20	15.3	1.20	15.1	1.18	14.8	1.10	14.8	0.79	-	-	-	-
			3824	3677	3489	3288	3046	2770	2438	1997	1355	-	-	-	-	-	-	-	-	-	-	-	-	
	1425	6973	18.5	1.16	17.7	1.20	16.8	1.24	16.5	1.27	16.1	1.29	15.9	1.32	15.7	1.30	15.5	1.25	15.4	1.10	-	-	-	-
3897			3753	3572	3375	3145	2887	2571	2174	1651	493	-	-	-	-	-	-	-	-	-	-	-		
1450	7095	18.9	1.22	18.1	1.26	17.2	1.30	16.8	1.34	16.5	1.36	16.2	1.39	16.1	1.37	15.9	1.34	15.8	1.24	16.1	0.80	-	-	
		3972	3829	3654	3462	3241	2992	2697	2349	1849	1028	-	-	-	-	-	-	-	-	-	-	-		
1470	7193	19.3	1.29	18.5	1.33	17.5	1.36	17.2	1.40	16.8	1.43	16.5	1.46	16.4	1.45	16.3	1.43	16.2	1.34	16.2	1.08	-	-	
		4032	3889	3720	3532	3318	3075	2793	2463	2006	1345	-	-	-	-	-	-	-	-	-	-	-		
19.5	1.34	18.7	1.38	17.8	1.42	17.4	1.46	17.1	1.49	16.8	1.51	16.7	1.52	16.6	1.50	16.5	1.43	16.5	1.24	-	-	-		

Performance shown is for installation type A: Free Inlet, Free Outlet. Power rating (BHP) does not include drive losses. For further information on estimating belt drive losses and motor service factors see page 11. The sound ratings shown are for loudness values in fan sones at 5'0" (1.5m) in a hemispherical free field per AMCA Standard 301. Values shown are for installation Type A: free inlet sone levels. Performance ratings do not include the effects of appurtenances in the airstream.

©PENN BARRY 2019

FUMEX

► FX14B Belt Drive Fan Curves

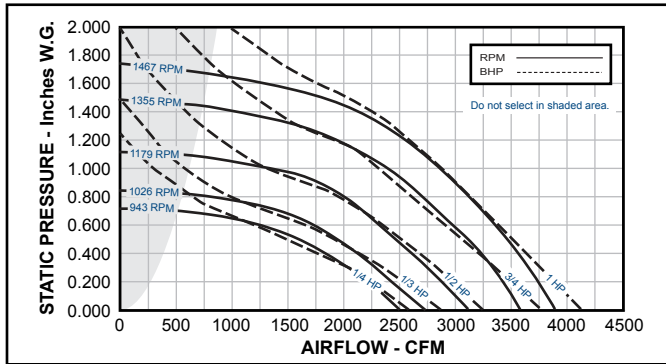

► FX14B Belt Drive Fan Dimensional Data

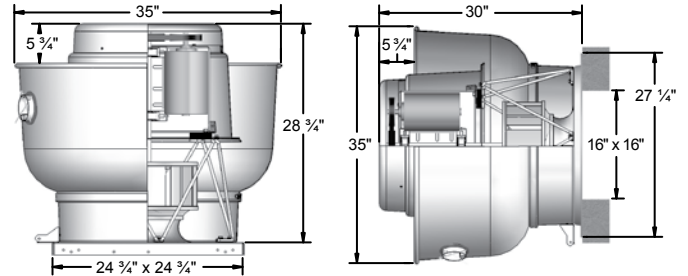

Galv. Steel Base = 16 Gage	Roof/Wall Opening = 16" SQ.	Peak BHP = (RPM/1462) ³
Aluminum Base = 0.064	Damper Size = 15 1/2" SQ.	Max. RPM = 2085 (1 1/2 HP)
Discharge Apron = 0.064	Max. Motor Frame Size = 56	Est. Ship Weight = 112 lbs.*

* Add 11 lbs. for Heat & Smoke option.

► FX14B Belt Drive Fan Performance Data

HP	RPM	Tip Speed FPM	0.000" SP		0.250" SP		0.500" SP		0.625" SP		0.750" SP		0.875" SP		1.000" SP		1.250" SP		1.375" SP		1.500" SP		
			Sones	BHP	Sones	BHP	Sones	BHP	Sones	BHP	Sones	BHP	Sones	BHP	Sones	BHP	Sones	BHP	Sones	BHP	Sones	BHP	Sones
1/4	400	1662	1061	-	-	-	-	-	-	-	-	-	-	-	-	-	-	-	-	-	-	-	-
	550	2286	4.8 0.02	-	-	-	-	-	-	-	-	-	-	-	-	-	-	-	-	-	-	-	-
	690	2868	1459	-	-	-	-	-	-	-	-	-	-	-	-	-	-	-	-	-	-	-	-
	815	3387	4.9 0.04	-	-	-	-	-	-	-	-	-	-	-	-	-	-	-	-	-	-	-	-
	880	3657	1830	1283	-	-	-	-	-	-	-	-	-	-	-	-	-	-	-	-	-	-	-
	943	3919	7.8 0.09	6.9 0.10	-	-	-	-	-	-	-	-	-	-	-	-	-	-	-	-	-	-	-
1/3	975	4052	2162	1743	673	-	-	-	-	-	-	-	-	-	-	-	-	-	-	-	-	-	-
	1000	4156	10.2 0.14	9.3 0.17	8.0 0.14	-	-	-	-	-	-	-	-	-	-	-	-	-	-	-	-	-	-
	1026	4264	2334	1955	1367	-	-	-	-	-	-	-	-	-	-	-	-	-	-	-	-	-	-
1/2	1050	4364	11.8 0.18	11.1 0.21	9.8 0.21	-	-	-	-	-	-	-	-	-	-	-	-	-	-	-	-	-	-
	1075	4468	2502	2154	1673	1230	-	-	-	-	-	-	-	-	-	-	-	-	-	-	-	-	-
	1100	4572	13.0 0.22	12.3 0.26	11.0 0.27	10.4 0.25	-	-	-	-	-	-	-	-	-	-	-	-	-	-	-	-	-
	1130	4696	2586	2253	1812	1480	-	-	-	-	-	-	-	-	-	-	-	-	-	-	-	-	-
	1160	4821	13.6 0.25	12.8 0.28	11.5 0.30	11.0 0.29	-	-	-	-	-	-	-	-	-	-	-	-	-	-	-	-	-
	1179	4900	2653	2330	1914	1615	887	-	-	-	-	-	-	-	-	-	-	-	-	-	-	-	-
3/4	1210	5029	14.3 0.29	13.7 0.32	12.5 0.35	12.0 0.35	11.4 0.32	-	-	-	-	-	-	-	-	-	-	-	-	-	-	-	-
	1240	5154	2785	2483	2110	1850	1504	-	-	-	-	-	-	-	-	-	-	-	-	-	-	-	-
	1270	5278	14.7 0.31	14.1 0.35	13.0 0.37	12.4 0.37	12.1 0.36	-	-	-	-	-	-	-	-	-	-	-	-	-	-	-	-
	1300	5403	2852	2559	2198	1963	1659	838	-	-	-	-	-	-	-	-	-	-	-	-	-	-	-
	1330	5528	15.2 0.33	14.5 0.37	13.4 0.39	12.9 0.40	12.6 0.39	12.2 0.32	-	-	-	-	-	-	-	-	-	-	-	-	-	-	-
	1355	5631	2918	2634	2285	2067	1791	1269	-	-	-	-	-	-	-	-	-	-	-	-	-	-	-
1	1385	5756	15.8 0.35	15.0 0.39	13.8 0.42	13.3 0.43	13.0 0.43	12.6 0.39	-	-	-	-	-	-	-	-	-	-	-	-	-	-	-
	1405	5839	16.6 0.38	15.9 0.43	14.6 0.45	14.0 0.46	13.5 0.46	13.3 0.44	13.2 0.33	-	-	-	-	-	-	-	-	-	-	-	-	-	-
	1430	5943	3077	2812	2490	2309	2072	1786	1147	-	-	-	-	-	-	-	-	-	-	-	-	-	-
	1450	6026	17.4 0.41	16.7 0.46	15.6 0.49	14.9 0.50	14.4 0.50	14.2 0.49	13.9 0.44	-	-	-	-	-	-	-	-	-	-	-	-	-	-
	1467	6097	3128	2867	2553	2377	2157	1889	1394	-	-	-	-	-	-	-	-	-	-	-	-	-	-
			18.1 0.43	17.4 0.48	16.2 0.51	15.6 0.52	15.0 0.52	14.9 0.52	14.7 0.49	-	-	-	-	-	-	-	-	-	-	-	-	-	-

Performance shown is for installation type A: Free Inlet, Free Outlet. Power rating (BHP) does not include drive losses. For further information on estimating belt drive losses and motor service factors see page 11. The sound ratings shown are for loudness values in fan sones at 50' (1.5m) in a hemispherical free field per AMCA Standard 301. Values shown are for installation Type A: free inlet sone levels. Performance ratings do not include the effects of appurtenances in the airstream.

Dimensional Information & Performance Data

Fumex | Belt Drive



FX16B

Centrifugal Fans

FX16B Belt Drive Fan Curves

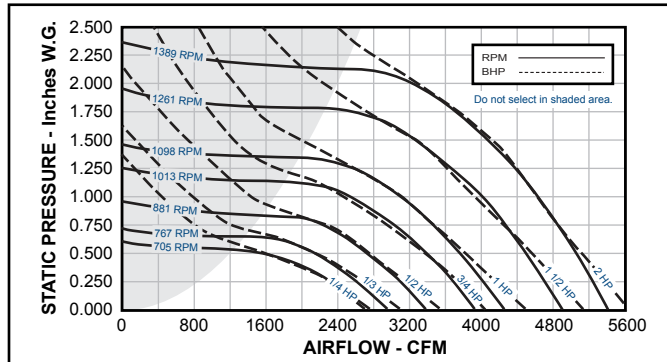

FX16B Belt Drive Fan Dimensional Data

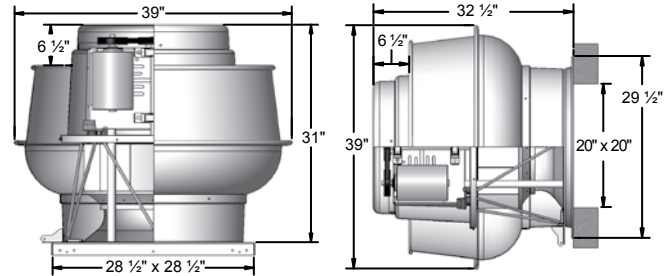

Galv. Steel Base = 14 Gage	Roof/Wall Opening = 20" SQ.	Peak BHP = (RPM/1095) ³
Aluminum Base = 0.080	Damper Size = 19 1/4" SQ.	Max. RPM = 1755 (3 HP)
Discharge Apron = 0.064	Max. Motor Frame Size = 145T	Est. Ship Weight = 144 lbs.*

* Add 11 lbs. for Heat & Smoke option.

FX16B Belt Drive Fan Performance Data

HP	RPM	Tip Speed FPM	0.000" SP		0.250" SP		0.500" SP		0.625" SP		0.750" SP		1.000" SP		1.250" SP		1.375" SP		1.500" SP		1.750" SP	
			Sones	BHP	Sones	BHP	Sones	BHP	Sones	BHP	Sones	BHP	Sones	BHP	Sones	BHP	Sones	BHP	Sones	BHP	Sones	BHP
1/4	500	2446	1999	1280	-	-	-	-	-	-	-	-	-	-	-	-	-	-	-	-	-	-
			6.0	0.08	5.2	0.09	-	-	-	-	-	-	-	-	-	-	-	-	-	-	-	-
	609	2979	2435	1951	-	-	-	-	-	-	-	-	-	-	-	-	-	-	-	-	-	-
			8.8	0.15	8.1	0.17	-	-	-	-	-	-	-	-	-	-	-	-	-	-	-	-
1/3	660	3229	2639	2213	-	-	-	-	-	-	-	-	-	-	-	-	-	-	-	-	-	-
			9.7	0.19	9.2	0.21	-	-	-	-	-	-	-	-	-	-	-	-	-	-	-	-
	705	3449	2819	2426	1791	-	-	-	-	-	-	-	-	-	-	-	-	-	-	-	-	-
			10.7	0.23	10.1	0.26	8.1	0.26	-	-	-	-	-	-	-	-	-	-	-	-	-	-
1/2	725	3547	2899	2518	1971	-	-	-	-	-	-	-	-	-	-	-	-	-	-	-	-	-
			11.1	0.25	10.6	0.28	8.6	0.29	-	-	-	-	-	-	-	-	-	-	-	-	-	-
	745	3645	2979	2611	2111	-	-	-	-	-	-	-	-	-	-	-	-	-	-	-	-	-
			11.6	0.27	11.1	0.30	9.2	0.32	-	-	-	-	-	-	-	-	-	-	-	-	-	-
3/4	800	3914	3199	2862	2434	2109	-	-	-	-	-	-	-	-	-	-	-	-	-	-	-	
			12.6	0.34	11.9	0.37	10.5	0.39	9.4	0.39	-	-	-	-	-	-	-	-	-	-	-	-
	830	4061	3319	2997	2596	2342	1791	-	-	-	-	-	-	-	-	-	-	-	-	-	-	-
			13.2	0.38	12.4	0.41	11.2	0.43	10.2	0.44	9.2	0.41	-	-	-	-	-	-	-	-	-	-
1	855	4183	3419	3106	2727	2497	2109	-	-	-	-	-	-	-	-	-	-	-	-	-	-	-
			13.7	0.41	12.9	0.45	11.7	0.47	10.9	0.48	9.8	0.46	-	-	-	-	-	-	-	-	-	-
	881	4310	3523	3219	2862	2645	2352	-	-	-	-	-	-	-	-	-	-	-	-	-	-	-
			14.3	0.45	13.5	0.49	12.3	0.51	11.6	0.52	10.6	0.52	-	-	-	-	-	-	-	-	-	-
1 1/2	920	4501	3679	3387	3062	2860	2635	-	-	-	-	-	-	-	-	-	-	-	-	-	-	-
			15.3	0.51	14.4	0.55	13.3	0.57	12.6	0.58	11.9	0.60	-	-	-	-	-	-	-	-	-	-
	955	4672	3819	3536	3233	3044	2841	2011	-	-	-	-	-	-	-	-	-	-	-	-	-	-
			16.3	0.57	15.5	0.61	14.4	0.64	13.7	0.65	13.0	0.66	11.1	0.61	-	-	-	-	-	-	-	-
2	1045	5112	4179	3918	3653	3506	3329	2930	-	-	-	-	-	-	-	-	-	-	-	-	-	
			18.2	0.75	17.2	0.79	16.2	0.83	15.7	0.84	15.1	0.85	13.7	0.87	-	-	-	-	-	-	-	-
	1070	5235	4279	4023	3768	3626	3459	3092	2287	-	-	-	-	-	-	-	-	-	-	-	-	
			18.7	0.81	17.8	0.84	16.8	0.89	16.3	0.90	15.7	0.91	14.4	0.94	12.8	0.86	-	-	-	-	-	-
2 1/2	1140	5577	4559	4317	4087	3953	3817	3491	3060	2656	-	-	-	-	-	-	-	-	-	-	-	
			21.0	0.97	19.9	1.01	19.1	1.07	18.6	1.08	18.1	1.09	16.9	1.11	15.0	1.13	14.1	1.08	-	-	-	-
	1180	5773	4719	4484	4267	4138	4009	3704	3352	3069	2634	-	-	-	-	-	-	-	-	-	-	
			22.0	1.08	21.0	1.12	20.0	1.18	20.0	1.19	19.4	1.20	18.3	1.23	16.8	1.26	15.7	1.24	14.9	1.18	-	-
1220	5969	4879	4652	4440	4321	4196	3913	3594	3397	3093	-	-	-	-	-	-	-	-	-	-		
		23.0	1.19	22.0	1.23	22.0	1.29	21.0	1.31	21.0	1.33	19.5	1.35	18.1	1.38	17.3	1.39	16.2	1.36	-	-	-
3	1261	6169	5043	4823	4617	4508	4387	4125	3827	3663	3453	2609	-	-	-	-	-	-	-	-		
			24.0	1.32	23.0	1.36	22.0	1.42	22.0	1.44	21.0	1.46	20.0	1.48	19.2	1.51	18.4	1.53	17.5	1.53	16.4	1.39
	1295	6335	5179	4965	4764	4661	4544	4299	4012	3858	3687	3102	-	-	-	-	-	-	-	-		
			25.0	1.43	24.0	1.47	23.0	1.53	23.0	1.56	22.0	1.57	21.0	1.60	20.0	1.63	19.3	1.65	18.5	1.66	17.0	1.60
1330	6507	5318	5111	4913	4817	4704	4475	4197	4055	3900	3452	-	-	-	-	-	-	-	-			
		26.0	1.55	25.0	1.59	24.0	1.65	23.0	1.68	23.0	1.70	22.0	1.73	21.0	1.76	20.0	1.77	19.5	1.79	17.7	1.77	
1365	6678	5458	5256	5063	4969	4864	4641	4380	4244	4100	3751	-	-	-	-	-	-	-	-			
		26.0	1.67	25.0	1.72	25.0	1.78	24.0	1.81	24.0	1.83	23.0	1.86	22.0	1.89	21.0	1.90	21.0	1.92	18.8	1.94	
1389	6795	5554	5355	5165	5073	4972	4753	4505	4371	4235	3920	-	-	-	-	-	-	-	-			
		27.0	1.76	26.0	1.81	25.0	1.87	25.0	1.90	24.0	1.93	23.0	1.96	22.0	1.99	22.0	2.00	21.0	2.02	19.7	2.05	

Performance shown is for installation type A: Free Inlet, Free Outlet. Power rating (BHP) does not include drive losses. For further information on estimating belt drive losses and motor service factors see page 11. The sound ratings shown are for loudness values in fan sones at 5'0" (1.5m) in a hemispherical free field per AMCA Standard 301. Values shown are for installation Type A: free inlet sone levels. Performance ratings do not include the effects of appurtenances in the airstream.

©PENN BARRY 2019

► **FX18B Belt Drive Fan Curves**

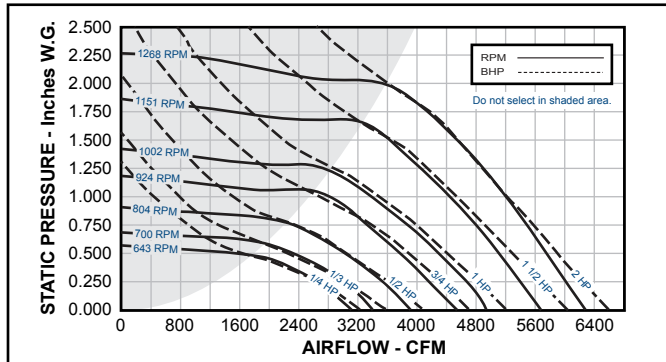

► **FX18B Belt Drive Fan Dimensional Data**

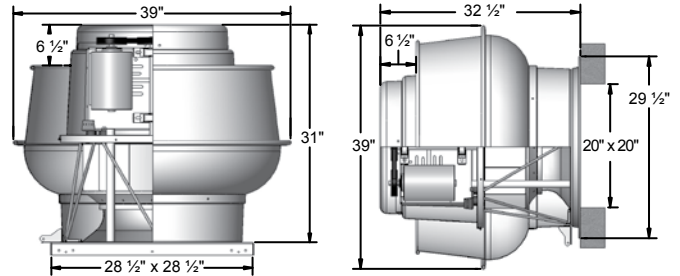

Galv. Steel Base = 14 Gage	Roof/Wall Opening = 20" SQ.	Peak BHP = (RPM/999) ³
Aluminum Base = 0.080	Damper Size = 19 1/4" SQ.	Max. RPM = 1403 (2 HP)
Discharge Apron = 0.064	Max. Motor Frame Size = 145T	Est. Ship Weight = 145 lbs.*

* Add 20 lbs. for Heat & Smoke option.

► **FX18B Belt Drive Fan Performance Data**

HP	RPM	Tip Speed FPM	0.000" SP		0.250" SP		0.500" SP		0.625" SP		0.750" SP		1.000" SP		1.250" SP		1.375" SP		1.500" SP		1.750" SP		
			Sones	BHP	Sones	BHP	Sones	BHP	Sones	BHP	Sones	BHP	Sones	BHP	Sones	BHP	Sones	BHP	Sones	BHP	Sones	BHP	Sones
1/4	400	2121	1984	-	-	-	-	-	-	-	-	-	-	-	-	-	-	-	-	-	-	-	-
	556	2948	4.7	0.05	-	-	-	-	-	-	-	-	-	-	-	-	-	-	-	-	-	-	-
			2758	2050	-	-	-	-	-	-	-	-	-	-	-	-	-	-	-	-	-	-	-
	600	3181	8.9	0.15	7.9	0.17	-	-	-	-	-	-	-	-	-	-	-	-	-	-	-	-	-
2976			2345	-	-	-	-	-	-	-	-	-	-	-	-	-	-	-	-	-	-	-	-
643	3409	10.0	0.18	9.0	0.21	-	-	-	-	-	-	-	-	-	-	-	-	-	-	-	-	-	-
		3189	2618	-	-	-	-	-	-	-	-	-	-	-	-	-	-	-	-	-	-	-	-
1/3	665	3525	11.1	0.23	10.3	0.26	-	-	-	-	-	-	-	-	-	-	-	-	-	-	-	-	-
			3299	2755	1885	-	-	-	-	-	-	-	-	-	-	-	-	-	-	-	-	-	-
	685	3631	11.6	0.25	10.8	0.28	9.8	0.28	-	-	-	-	-	-	-	-	-	-	-	-	-	-	-
			3398	2873	2147	-	-	-	-	-	-	-	-	-	-	-	-	-	-	-	-	-	-
700	3711	12.0	0.27	11.2	0.31	10.4	0.32	-	-	-	-	-	-	-	-	-	-	-	-	-	-	-	-
		3472	2961	2279	-	-	-	-	-	-	-	-	-	-	-	-	-	-	-	-	-	-	-
1/2	730	3870	12.3	0.29	11.7	0.33	10.7	0.35	-	-	-	-	-	-	-	-	-	-	-	-	-	-	-
			3621	3136	2503	-	-	-	-	-	-	-	-	-	-	-	-	-	-	-	-	-	-
	760	4029	13.2	0.33	12.6	0.37	11.7	0.39	-	-	-	-	-	-	-	-	-	-	-	-	-	-	-
			3770	3309	2716	2328	-	-	-	-	-	-	-	-	-	-	-	-	-	-	-	-	-
785	4162	14.2	0.37	13.7	0.42	12.8	0.44	12.3	0.44	-	-	-	-	-	-	-	-	-	-	-	-	-	-
		3894	3452	2890	2569	-	-	-	-	-	-	-	-	-	-	-	-	-	-	-	-	-	-
804	4262	15.1	0.41	14.7	0.46	13.9	0.48	13.4	0.49	-	-	-	-	-	-	-	-	-	-	-	-	-	-
		3988	3559	3021	2710	-	-	-	-	-	-	-	-	-	-	-	-	-	-	-	-	-	-
3/4	840	4453	15.9	0.44	15.5	0.49	14.8	0.52	14.3	0.52	-	-	-	-	-	-	-	-	-	-	-	-	-
			4167	3759	3261	2968	2640	-	-	-	-	-	-	-	-	-	-	-	-	-	-	-	-
	870	4612	16.7	0.50	16.3	0.56	15.6	0.59	15.1	0.59	14.6	0.59	-	-	-	-	-	-	-	-	-	-	-
			4316	3922	3454	3179	2891	-	-	-	-	-	-	-	-	-	-	-	-	-	-	-	-
900	4771	17.2	0.56	16.8	0.61	16.1	0.65	15.6	0.66	15.1	0.66	-	-	-	-	-	-	-	-	-	-	-	-
		4464	4084	3643	3385	3108	-	-	-	-	-	-	-	-	-	-	-	-	-	-	-	-	-
924	4899	17.6	0.62	17.3	0.68	16.6	0.71	16.2	0.72	15.7	0.73	-	-	-	-	-	-	-	-	-	-	-	-
		4584	4212	3794	3548	3279	-	-	-	-	-	-	-	-	-	-	-	-	-	-	-	-	-
1	950	5036	18.3	0.67	17.8	0.73	17.1	0.76	16.6	0.78	16.1	0.79	-	-	-	-	-	-	-	-	-	-	-
			4712	4351	3952	3716	3461	2805	-	-	-	-	-	-	-	-	-	-	-	-	-	-	-
	975	5169	19.2	0.73	18.7	0.79	18.0	0.83	17.4	0.84	16.9	0.86	15.7	0.84	-	-	-	-	-	-	-	-	-
			4837	4485	4100	3876	3634	3093	-	-	-	-	-	-	-	-	-	-	-	-	-	-	-
1002	5312	20.0	0.79	19.6	0.85	18.9	0.89	18.3	0.91	17.8	0.92	16.7	0.93	-	-	-	-	-	-	-	-	-	-
		4970	4628	4258	4047	3818	3319	-	-	-	-	-	-	-	-	-	-	-	-	-	-	-	-
1 1/2	1040	5513	21.0	0.85	20.0	0.92	19.9	0.96	19.4	0.98	18.9	1.00	17.7	1.01	-	-	-	-	-	-	-	-	-
			5159	4829	4479	4285	4067	3595	-	-	-	-	-	-	-	-	-	-	-	-	-	-	-
	1080	5726	22.0	0.95	21.0	1.02	21.0	1.07	20.0	1.09	19.7	1.11	18.5	1.13	-	-	-	-	-	-	-	-	-
			5357	5039	4709	4525	4322	3878	3357	-	-	-	-	-	-	-	-	-	-	-	-	-	-
1120	5938	22.0	1.07	22.0	1.14	21.0	1.20	21.0	1.21	20.0	1.23	19.3	1.26	18.3	1.26	-	-	-	-	-	-	-	-
		5556	5249	4937	4759	4574	4156	3709	3364	-	-	-	-	-	-	-	-	-	-	-	-	-	
1151	6102	23.0	1.19	23.0	1.26	22.0	1.33	22.0	1.35	21.0	1.36	20.0	1.40	18.9	1.42	18.7	1.39	-	-	-	-	-	-
		5710	5411	5113	4940	4767	4368	3935	3696	-	-	-	-	-	-	-	-	-	-	-	-	-	
2	1190	6309	24.0	1.29	23.0	1.37	23.0	1.44	22.0	1.46	22.0	1.47	21.0	1.51	19.5	1.53	19.2	1.53	-	-	-	-	-
			5903	5614	5327	5165	4997	4626	4213	4002	3752	-	-	-	-	-	-	-	-	-	-	-	
	1215	6441	24.0	1.43	24.0	1.51	24.0	1.58	23.0	1.60	23.0	1.62	22.0	1.66	21.0	1.69	20.0	1.70	19.8	1.69	-	-	-
			6027	5744	5463	5308	5144	4786	4388	4183	3970	-	-	-	-	-	-	-	-	-	-		
1245	6600	25.0	1.52	25.0	1.60	24.0	1.67	24.0	1.70	23.0	1.72	22.0	1.76	21.0	1.79	21.0	1.80	20.0	1.81	20.0	1.81	-	-
		6176	5899	5625	5479	5319	4977	4597	4397	4195	3541	-	-	-	-	-	-	-	-	-			
1268	6722	26.0	1.64	25.0	1.72	25.0	1.79	25.0	1.83	24.0	1.84	23.0	1.89	22.0	1.92	22.0	1.93	21.0	1.94	21.0	1.94	21.0	1.87
		6290	6019	5749	5610	5453	5123	4755	4558	4362	3850	-	-	-	-	-	-	-	-	-			
1268	6722	26.0	1.73	26.0	1.81	25.0	1.89	25.0	1.92	25.0	1.94	24.0	1.99	23.0	2.03	22.0	2.04	22.0	2.05	22.0	2.05	21.0	2.03
		6290	6019	5749	5610	5453	5123	4755	4558	4362	3850	-	-	-	-	-	-	-	-	-			

Performance shown is for installation type A: Free Inlet, Free Outlet. Power rating (BHP) does not include drive losses. For further information on estimating belt drive losses and motor service factors see page 11. The sound ratings shown are for loudness values in fan sones at 50' (1.5m) in a hemispherical free field per AMCA Standard 301. Values shown are for installation Type A: free inlet sone levels. Performance ratings do not include the effects of appurtenances in the airstream.

Dimensional Information & Performance Data

Fumex | Belt Drive



FX18BH

Centrifugal Fans

FX18BH Belt Drive Fan Curves

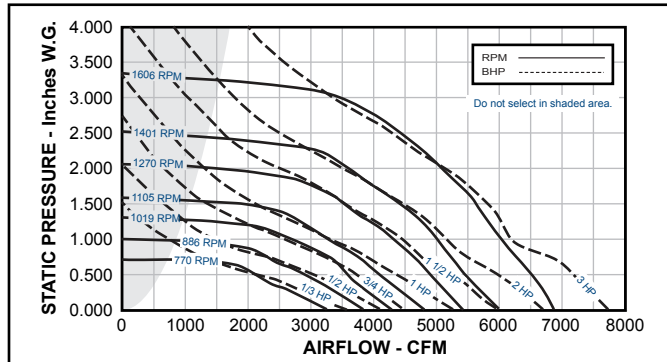

FX18BH Belt Drive Fan Dimensional Data

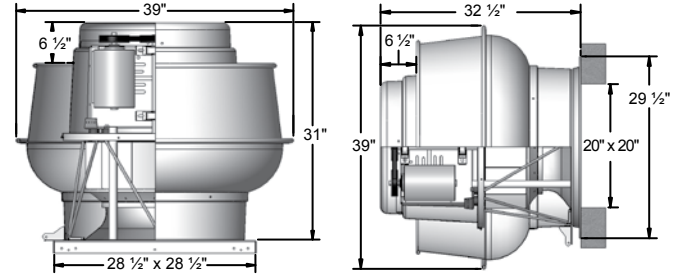

Galv. Steel Base = 14 Gage	Roof/Wall Opening = 20" SQ.	Peak BHP = (RPM/1106) ³
Aluminum Base = 0.080	Damper Size = 19 1/4" SQ.	Max. RPM = 1870 (3 HP)
Discharge Apron = 0.064	Max. Motor Frame Size = 145T	Wall Mounted Max. HP = 2
Est. Ship Weight = 142 lbs.*		

FX18BH Belt Drive Fan Performance Data

* Add 20 lbs. for Heat & Smoke option.

HP	RPM	Tip Speed FPM	0.500" SP		0.750" SP		1.000" SP		1.250" SP		1.500" SP		1.750" SP		2.000" SP		2.250" SP		2.500" SP		3.000" SP													
			Sones	BHP	Sones	BHP	Sones	BHP	Sones	BHP	Sones	BHP	Sones	BHP	Sones	BHP	Sones	BHP	Sones	BHP	Sones	BHP	Sones	BHP										
1/3	770	4082	2308		-		-		-		-		-		-		-		-		-		-											
			7.6	0.33	-		-		-		-		-		-		-		-		-		-		-									
1/2	800	4241	2520		1622		-		-		-		-		-		-		-		-		-		-									
			7.9	0.37	8.1	0.36	-		-		-		-		-		-		-		-		-		-		-							
	840	4453	2773		2108		-		-		-		-		-		-		-		-		-		-		-							
			8.4	0.42	8.9	0.44	-		-		-		-		-		-		-		-		-		-		-							
886	4697	3028		2436		-		-		-		-		-		-		-		-		-		-		-		-						
		9.4	0.48	9.4	0.52	-		-		-		-		-		-		-		-		-		-		-		-						
3/4	915	4851	3186		2628		1676		-		-		-		-		-		-		-		-		-		-		-					
			10.1	0.53	9.9	0.57	10.0	0.52	-		-		-		-		-		-		-		-		-		-		-					
	970	5142	3475		3017		2435		-		-		-		-		-		-		-		-		-		-		-					
11.5			0.62	10.7	0.66	11.5	0.68	-		-		-		-		-		-		-		-		-		-		-						
1	1019	5402	3712		3342		2786		1779		-		-		-		-		-		-		-		-		-		-					
			12.4	0.71	11.3	0.75	12.0	0.79	12.1	0.71	-		-		-		-		-		-		-		-		-		-					
			3932		3598		3093		2515		-		-		-		-		-		-		-		-		-		-		-			
1	1065	5646	13.0		0.81		11.9		0.85		12.4		0.89		13.3		0.88		-		-		-		-		-		-					
			4003		3681		3200		2675		-		-		-		-		-		-		-		-		-		-		-			
			13.2	0.84	12.2	0.88	12.5	0.93	13.6	0.93	-		-		-		-		-		-		-		-		-		-					
1	1105	5858	4121		3818		3378		2884		1361		-		-		-		-		-		-		-		-		-					
			13.5	0.90	12.6	0.93	12.7	0.98	13.7	1.00	13.4	0.73	-		-		-		-		-		-		-		-		-					
			4216		3926		3519		3019		2151		-		-		-		-		-		-		-		-		-		-			
1 1/2	1125	5964	13.9		0.94		12.9		0.98		12.8		1.03		13.9		1.06		14.1		0.98		-		-		-		-					
			4333		4061		3693		3186		2575		-		-		-		-		-		-		-		-		-		-			
	1150	6097	14.2		1.00		13.4		1.04		13.0		1.09		14.1		1.13		14.8		1.10		-		-		-		-		-			
			4450		4193		3850		3352		2844		-		-		-		-		-		-		-		-		-		-			
	1175	6229	14.7		1.07		14.0		1.11		13.3		1.15		14.3		1.20		15.5		1.19		-		-		-		-		-			
			4570		4315		3990		3525		3088		1920		-		-		-		-		-		-		-		-		-			
	1200	6362	15.3		1.13		14.5		1.17		13.6		1.22		14.6		1.28		15.7		1.29		15.5		1.11		-		-		-			
4697			4436		4129		3703		3258		2544		-		-		-		-		-		-		-		-		-					
1225	6494	16.1		1.18		15.2		1.24		14.3		1.29		14.9		1.34		16.0		1.37		16.4		1.3		-		-		-				
		4925		4652		4376		4019		3559		3081		-		-		-		-		-		-		-		-		-				
1270	6733	17.0		1.29		16.2		1.38		15.3		1.42		15.3		1.47		16.5		1.52		17.7		1.51		-		-		-				
		4975		4700		4430		4089		3625		3188		1895		-		-		-		-		-		-		-		-				
2	1280	6786	17.1		1.32		16.3		1.41		15.5		1.45		15.4		1.50		16.6		1.56		17.9		1.55		17.3		1.28		-			
			5251		4961		4728		4424		4008		3599		3051		-		-		-		-		-		-		-		-			
	1335	7077	18.4		1.46		17.2		1.58		16.6		1.63		16.1		1.68		17.1		1.74		18.4		1.77		19.2		1.73		-			
			5449		5150		4931		4646		4290		3865		3478		2571		-		-		-		-		-		-		-			
	1375	7289	19.4		1.57		18.2		1.72		17.6		1.77		17.1		1.82		17.5		1.88		18.8		1.93		20.0		1.93		19.9		1.78	
5578			5272		5057		4789		4471		4036		3670		3073		-		-		-		-		-		-		-					
1401	7427	20.0		1.64		18.8		1.82		18.2		1.86		17.8		1.91		17.9		1.97		19.1		2.04		20.0		2.05		21.0		1.98		
		5770		5454		5245		5002		4720		4315		3933		3494		2481		-		-		-		-		-		-				
3	1440	7634	21.0		1.76		19.8		1.96		19.3		2.01		18.8		2.06		18.7		2.12		19.6		2.19		21.0		2.22		22.0		2.20	
			5958		5650		5436		5218		4944		4598		4198		3852		3274		-		-		-		-		-		-		-	
	1480	7846	22.0		1.89		21.0		2.11		20.0		2.17		20.0		2.22		19.7		2.28		20.0		2.35		21.0		2.41		23.0		2.41	
			6139		5853		5627		5428		5165		4876		4474		4122		3705		-		-		-		-		-		-		-	
	1520	8058	24.0		2.03		22.0		2.24		22.0		2.34		21.0		2.39		21.0		2.45		21.0		2.51		22.0		2.59		23.0		2.61	
			6321		6055		5816		5623		5385		5124		4759		4389		4060		1714		-		-		-		-		-		-	
	1560	8270	25.0		2.19		24.0		2.39		23.0		2.52		23.0		2.57		23.0		2.63		22.0		2.69		23.0		2.77		24.0		2.82	
6434			6181		5934		5744		5520		5264		4935		4553		4230		2907		-		-		-		-		-		-			
1585	8403	26.0		2.28		25.0		2.48		24.0		2.64		24.0		2.69		23.0		2.75		23.0		2.81		23.0		2.88		24.0		2.96		
		6528		6286		6032		5845		5634		5381		5081		4700		4371		3378		-		-		-		-		-		-		
1606	8514	27.0		2.37		25.0		2.56		24.0		2.74		24.0		2.79		24.0		2.85		24.0		2.91		24.0		2.98		25.0		3.06		
		6528		6286		6032		5845		5634		5381		5081		4700		4371		3378		-		-		-		-		-		-		

Performance shown is for installation type A: Free Inlet, Free Outlet. Power rating (BHP) does not include drive losses. For further information on estimating belt drive losses and motor service factors see page 11. The sound ratings shown are for loudness values in fan sones at 5'0" (1.5m) in a hemispherical free field per AMCA Standard 301. Values shown are for installation Type A: free inlet sone levels. Performance ratings do not include the effects of appurtenances in the airstream.

©PENN BARRY 2009

FUMEX

› FX24B Belt Drive Fan Curves

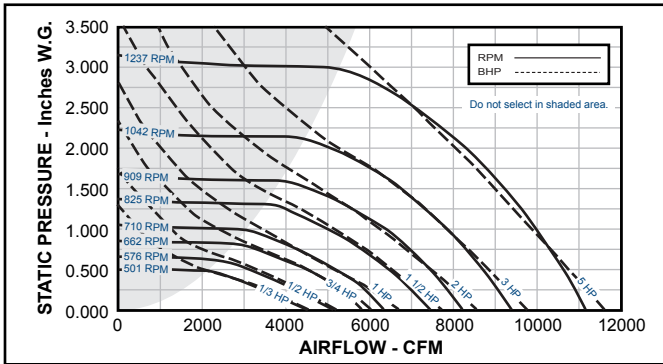

› FX24B Belt Drive Fan Dimensional Data

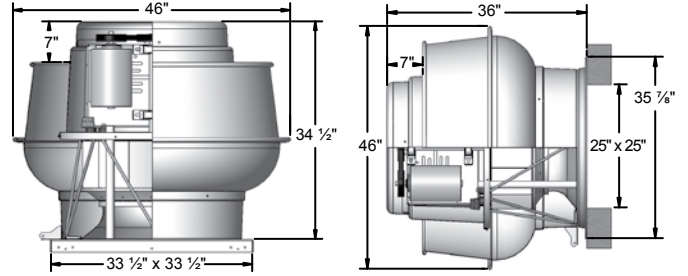

Galv. Steel Base = 14 Gage	Roof/Wall Opening = 25" SQ.	Peak BHP = (RPM/716) ³
Aluminum Base = 0.080	Damper Size = 24 1/2" SQ.	Max. RPM = 1360 (5 HP)
Discharge Apron = 0.064	Max. Motor Frame Size = 184T	Wall Mounted Max. HP = 2
Est. Ship Weight = 190 lbs.*		

› FX24B Belt Drive Fan Performance Data

* Add 40 lbs. for Heat & Smoke option.

HP	RPM	Tip Speed FPM	0.250" SP		0.500" SP		0.750" SP		1.000" SP		1.250" SP		1.500" SP		1.750" SP		2.000" SP		2.250" SP		2.500" SP		
			Sones	BHP	Sones	BHP	Sones	BHP	Sones	BHP	Sones	BHP	Sones	BHP	Sones	BHP	Sones	BHP	Sones	BHP	Sones	BHP	Sones
1/4	375	2436	1986	-	-	-	-	-	-	-	-	-	-	-	-	-	-	-	-	-	-	-	-
	420	2728	5.9 0.14	-	-	-	-	-	-	-	-	-	-	-	-	-	-	-	-	-	-	-	-
	461	2995	7.3 0.20	-	-	-	-	-	-	-	-	-	-	-	-	-	-	-	-	-	-	-	-
1/3	480	3118	3245	-	-	-	-	-	-	-	-	-	-	-	-	-	-	-	-	-	-	-	-
	501	3255	8.7 0.27	-	-	-	-	-	-	-	-	-	-	-	-	-	-	-	-	-	-	-	-
	540	3508	10.4 0.34	-	-	-	-	-	-	-	-	-	-	-	-	-	-	-	-	-	-	-	-
1/2	540	3508	4163	2992	-	-	-	-	-	-	-	-	-	-	-	-	-	-	-	-	-	-	-
	576	3742	11.9 0.42	10.7 0.42	-	-	-	-	-	-	-	-	-	-	-	-	-	-	-	-	-	-	-
	610	3963	12.9 0.51	11.7 0.52	-	-	-	-	-	-	-	-	-	-	-	-	-	-	-	-	-	-	-
3/4	610	3963	4896	4036	-	-	-	-	-	-	-	-	-	-	-	-	-	-	-	-	-	-	-
	640	4157	14.0 0.60	12.9 0.62	-	-	-	-	-	-	-	-	-	-	-	-	-	-	-	-	-	-	-
	662	4300	5203	4433	3236	-	-	-	-	-	-	-	-	-	-	-	-	-	-	-	-	-	-
1	690	4482	14.9 0.69	14.0 0.72	12.8 0.67	-	-	-	-	-	-	-	-	-	-	-	-	-	-	-	-	-	-
	718	4664	5421	4709	3676	-	-	-	-	-	-	-	-	-	-	-	-	-	-	-	-	-	-
	755	4905	15.5 0.76	14.7 0.79	13.6 0.77	-	-	-	-	-	-	-	-	-	-	-	-	-	-	-	-	-	-
1 1/2	690	4482	5697	5040	4126	-	-	-	-	-	-	-	-	-	-	-	-	-	-	-	-	-	-
	718	4664	16.2 0.85	15.4 0.89	14.3 0.89	-	-	-	-	-	-	-	-	-	-	-	-	-	-	-	-	-	-
	755	4905	5972	5367	4542	3116	-	-	-	-	-	-	-	-	-	-	-	-	-	-	-	-	-
2	755	4905	6332	5791	5049	4070	-	-	-	-	-	-	-	-	-	-	-	-	-	-	-	-	-
	790	5132	18.2 1.10	17.4 1.16	16.4 1.18	15.3 1.12	-	-	-	-	-	-	-	-	-	-	-	-	-	-	-	-	-
	825	5359	6670	6167	5510	4663	-	-	-	-	-	-	-	-	-	-	-	-	-	-	-	-	-
3	850	5522	19.7 1.25	19.0 1.32	18.1 1.35	16.9 1.33	-	-	-	-	-	-	-	-	-	-	-	-	-	-	-	-	-
	880	5717	7007	6534	5937	5185	4151	-	-	-	-	-	-	-	-	-	-	-	-	-	-	-	-
	909	5905	21.0 1.42	19.9 1.49	19.0 1.53	18.0 1.53	16.8 1.43	-	-	-	-	-	-	-	-	-	-	-	-	-	-	-	-
4	850	5522	7246	6793	6231	5538	4660	-	-	-	-	-	-	-	-	-	-	-	-	-	-	-	-
	880	5717	21.0 1.55	20.0 1.62	19.5 1.67	18.5 1.68	17.5 1.61	-	-	-	-	-	-	-	-	-	-	-	-	-	-	-	-
	909	5905	7532	7103	6580	5939	5165	3845	-	-	-	-	-	-	-	-	-	-	-	-	-	-	-
5	950	6171	22.0 1.71	21.0 1.79	20.0 1.84	19.3 1.87	18.3 1.83	17.3 1.63	-	-	-	-	-	-	-	-	-	-	-	-	-	-	-
	985	6399	7808	7397	6913	6321	5599	4660	-	-	-	-	-	-	-	-	-	-	-	-	-	-	-
	1015	6593	23.0 1.88	23.0 1.97	22.0 2.03	21.0 2.06	19.6 2.04	18.4 1.92	-	-	-	-	-	-	-	-	-	-	-	-	-	-	-
6	950	6171	8197	7803	7367	6824	6187	5435	4130	-	-	-	-	-	-	-	-	-	-	-	-	-	-
	985	6399	25.0 2.14	25.0 2.23	24.0 2.30	23.0 2.34	22.0 2.35	21.0 2.29	19.3 2.05	-	-	-	-	-	-	-	-	-	-	-	-	-	-
	1015	6593	8527	8148	7736	7236	6655	5973	5102	-	-	-	-	-	-	-	-	-	-	-	-	-	-
7	1042	6769	28.0 2.37	27.0 2.47	26.0 2.55	25.0 2.60	24.0 2.62	23.0 2.59	22.0 2.45	-	-	-	-	-	-	-	-	-	-	-	-	-	-
	1100	7146	8809	8441	8050	7585	7050	6417	5681	4389	-	-	-	-	-	-	-	-	-	-	-	-	-
	1150	7470	29.0 2.59	28.0 2.69	27.0 2.78	26.0 2.83	25.0 2.86	24.0 2.86	23.0 2.77	22.0 2.49	-	-	-	-	-	-	-	-	-	-	-	-	-
8	1042	6769	9062	8705	8330	7896	7390	6795	6123	5217	-	-	-	-	-	-	-	-	-	-	-	-	-
	1100	7146	29.0 2.80	29.0 2.90	28.0 2.99	27.0 3.05	26.0 3.09	25.0 3.10	24.0 3.04	23.0 2.87	-	-	-	-	-	-	-	-	-	-	-	-	-
	1150	7470	9605	9267	8927	8539	8076	7568	6985	6327	5393	-	-	-	-	-	-	-	-	-	-	-	-
9	1100	7146	30.0 3.28	30.0 3.39	29.0 3.50	28.0 3.57	27.0 3.62	26.0 3.65	25.0 3.64	24.0 3.56	23.0 3.35	-	-	-	-	-	-	-	-	-	-	-	-
	1200	7795	10071	9749	9424	9065	8656	8197	7669	7085	6427	5428	-	-	-	-	-	-	-	-	-	-	-
	1237	8036	32.0 3.74	31.0 3.85	30.0 3.96	29.0 4.05	28.0 4.11	27.0 4.16	26.0 4.17	25.0 4.13	24.0 4.02	23.0 3.77	-	-	-	-	-	-	-	-	-	-	-
10	1100	7146	10536	10228	9916	9586	9227	8788	8330	7804	7221	6552	-	-	-	-	-	-	-	-	-	-	-
	1150	7470	34.0 4.23	33.0 4.35	33.0 4.47	32.0 4.57	31.0 4.65	30.0 4.70	29.0 4.73	28.0 4.73	27.0 4.67	26.0 4.53	-	-	-	-	-	-	-	-	-	-	-
	1200	7795	10879	10581	10279	9968	9623	9219	8793	8300	7770	7190	-	-	-	-	-	-	-	-	-	-	-
11	1100	7146	36.0 4.63	35.0 4.75	35.0 4.87	34.0 4.99	33.0 5.07	32.0 5.13	31.0 5.18	30.0 5.18	29.0 5.16	28.0 5.08	-	-	-	-	-	-	-	-	-	-	-

Performance shown is for installation type A: Free Inlet, Free Outlet. Power rating (BHP) does not include drive losses. For further information on estimating belt drive losses and motor service factors see page 11. The sound ratings shown are for loudness values in fan sones at 50' (1.5m) in a hemispherical free field per AMCA Standard 301. Values shown are for installation Type A: free inlet sone levels. Performance ratings do not include the effects of appurtenances in the airstream.

Dimensional Information & Performance Data

Fumex | Belt Drive



FX24BH

Centrifugal Fans

FX24BH Belt Drive Fan Curves

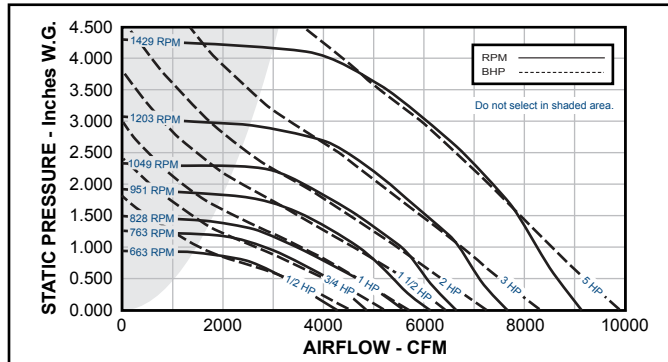

FX24BH Belt Drive Fan Dimensional Data

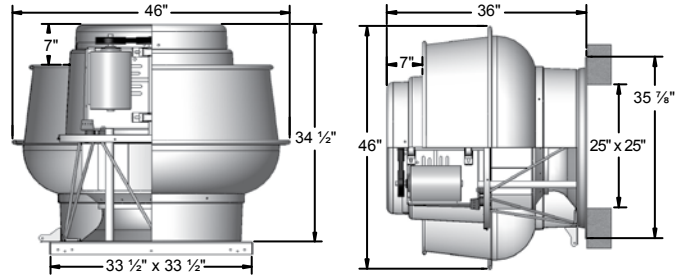

Galv. Steel Base = 14 Gage	Roof Opening = 25" SQ.	Peak BHP = (RPM/827) ³
Aluminum Base = 0.080	Damper Size = 24 1/4" SQ.	Max. RPM = 1620 (5 HP)
Discharge Apron = 0.064	Max. Motor Frame Size = 184T	Wall Mounted Max. HP = 2
Est. Ship Weight = 187 lbs.*		

FX24BH Belt Drive Fan Performance Data

* Add 40 lbs. for Heat & Smoke option.

HP	RPM	Tip Speed FPM	0.500" SP		0.750" SP		1.000" SP		1.250" SP		1.500" SP		1.750" SP		2.000" SP		2.250" SP		2.500" SP		3.000" SP			
			Sones	BHP	Sones	BHP	Sones	BHP	Sones	BHP	Sones	BHP	Sones	BHP	Sones	BHP	Sones	BHP	Sones	BHP	Sones	BHP	Sones	BHP
1/2	600	3897	2641	-	-	-	-	-	-	-	-	-	-	-	-	-	-	-	-	-	-	-	-	
	663	4306	8.9	0.38	3231	2472	-	-	-	-	-	-	-	-	-	-	-	-	-	-	-	-	-	
3/4	707	4592	10.0	0.51	10.3	0.51	1877	-	-	-	-	-	-	-	-	-	-	-	-	-	-	-	-	
	725	4709	3633	2971	3774	3142	2264	-	-	-	-	-	-	-	-	-	-	-	-	-	-	-	-	
	763	4956	11.1	0.65	11.3	0.67	11.4	0.64	-	-	-	-	-	-	-	-	-	-	-	-	-	-	-	
1	800	5196	4069	3497	4351	3844	3259	2352	-	-	-	-	-	-	-	-	-	-	-	-	-	-	-	
	828	5378	11.9	0.75	12.0	0.78	12.3	0.78	-	-	-	-	-	-	-	-	-	-	-	-	-	-	-	
1 1/2	855	5553	12.7	0.94	12.8	0.98	12.9	1.00	13.4	0.98	-	-	-	-	-	-	-	-	-	-	-	-	-	
	886	5755	4736	4357	4950	4607	4083	3546	2740	-	-	-	-	-	-	-	-	-	-	-	-	-	-	
	915	5943	13.1	1.03	13.1	1.07	13.3	1.10	13.6	1.09	13.3	0.93	-	-	-	-	-	-	-	-	-	-	-	
	925	6008	13.7	1.13	13.7	1.19	13.7	1.22	14.0	1.23	14.3	1.17	-	-	-	-	-	-	-	-	-	-	-	
	951	6177	14.7	1.23	14.6	1.30	14.6	1.34	14.6	1.35	14.9	1.33	-	-	-	-	-	-	-	-	-	-	-	
2	990	6430	5216	4910	5393	5110	4695	4198	3655	2859	-	-	-	-	-	-	-	-	-	-	-	-	-	
	1019	6619	15.2	1.27	15.0	1.34	15.0	1.38	14.9	1.40	15.0	1.38	14.8	1.20	-	-	-	-	-	-	-	-	-	
	1049	6814	16.0	1.37	15.7	1.45	15.7	1.49	15.6	1.51	15.5	1.51	15.8	1.43	2353	-	-	-	-	-	-	-	-	
3	1080	7015	16.9	1.53	16.5	1.62	16.5	1.67	16.5	1.70	16.5	1.72	16.7	1.69	3096	-	-	-	-	-	-	-	-	
	1105	7177	5856	5605	6063	5813	5522	5115	4667	4203	3597	2447	-	-	-	-	-	-	-	-	-	-	-	
	1125	7307	17.4	1.66	16.9	1.75	16.9	1.81	16.9	1.85	17.0	1.87	17.2	1.85	3096	3096	3096	3096	3096	3096	3096	3096	3096	
	1175	7632	6276	6027	6447	6198	5953	5635	5184	4777	4301	2689	2546	-	-	-	-	-	-	-	-	-	-	
	1203	7814	18.8	1.95	18.0	2.05	18.0	2.13	18.0	2.18	18.1	2.21	18.4	2.23	4005	4005	4005	4005	4005	4005	4005	4005	4005	
	1210	7859	19.5	2.08	18.6	2.18	18.6	2.32	18.6	2.32	18.6	2.36	18.9	2.38	4301	4301	4301	4301	4301	4301	4301	4301	4301	
5	1245	8087	6583	6335	6795	6546	6297	6048	5799	5550	5301	5052	4803	4554	4305	4056	3807	3558	3309	3060	2811	2562	2313	
	1275	8281	20.0	2.19	19.3	2.29	19.1	2.39	19.1	2.44	19.1	2.48	19.3	2.51	4555	4555	4555	4555	4555	4555	4555	4555	4555	
	1325	8606	6923	6675	7122	6864	6655	6407	6105	5896	5690	5484	5278	5072	4866	4660	4454	4248	4042	3836	3630	3424	3218	
	1380	8963	22.0	2.48	21.0	2.58	21.0	2.69	21.0	2.75	21.0	2.80	21.0	2.84	5047	5047	5047	5047	5047	5047	5047	5047	5047	5047
	1429	9282	22.0	2.65	22.0	2.76	21.0	2.86	21.0	2.94	21.0	3.00	21.0	3.04	5429	5429	5429	5429	5429	5429	5429	5429	5429	5429
	1429	9282	23.0	2.69	22.0	2.80	21.0	2.91	21.0	2.99	21.0	3.05	21.0	3.09	5811	5811	5811	5811	5811	5811	5811	5811	5811	5811

Performance shown is for installation type A: Free Inlet, Free Outlet. Power rating (BHP) does not include drive losses. For further information on estimating belt drive losses and motor service factors see page 11. The sound ratings shown are for loudness values in fan sones at 5'0" (1.5m) in a hemispherical free field per AMCA Standard 301. Values shown are for installation Type A: free inlet sone levels. Performance ratings do not include the effects of appurtenances in the airstream.

FUMEX

©PENNBARRY 2019

› FX27B Belt Drive Fan Curves

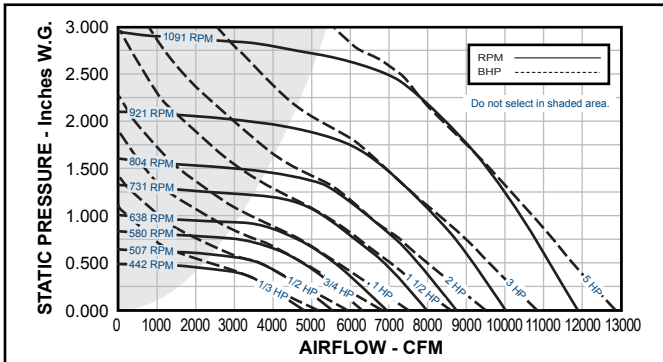

› FX27B Belt Drive Fan Dimensional Data

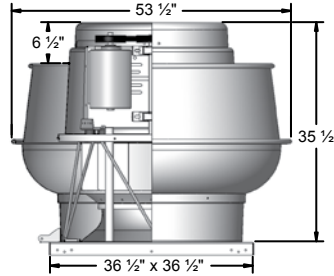

Galv. Steel Base = 14 Gage	Roof Opening = 28" SQ.	Peak BHP = (RPM/539) ³
Aluminum Base = 0.080	Damper Size = 27 1/4" SQ.	Max. RPM = 1188 (5 HP)
Discharge Apron = 0.080	Max. Motor Frame Size = 184T	Est. Ship Weight = 219 lbs.*

* Add 55 lbs. for Heat & Smoke option.

› FX27B Belt Drive Fan Performance Data

HP	RPM	Tip Speed FPM	0.125" SP		0.250" SP		0.375" SP		0.500" SP		0.750" SP		1.000" SP		1.250" SP		1.500" SP		2.000" SP	
			Sones	BHP	Sones	BHP	Sones	BHP	Sones	BHP	Sones	BHP	Sones	BHP	Sones	BHP	Sones	BHP	Sones	BHP
1/3	442	3211	4361		3843		3112		-		-		-		-		-		-	
			8.3	0.30	7.7	0.33	7.1	0.33	-	-	-	-	-	-	-	-	-	-	-	-
1/2	475	3451	4780		4293		3695		2634		-		-		-		-		-	
			9.7	0.37	9.0	0.40	8.6	0.41	7.6	0.38	-	-	-	-	-	-	-	-	-	-
1/2	507	3683	5120		4710		4213		3530		-		-		-		-		-	
			10.7	0.44	10.1	0.48	9.8	0.50	9.2	0.49	-	-	-	-	-	-	-	-	-	-
3/4	535	3887	5444		5065		4617		4030		-		-		-		-		-	
			11.7	0.51	11.1	0.55	10.7	0.58	10.3	0.59	-	-	-	-	-	-	-	-	-	-
3/4	560	4068	4361		4361		4361		4361		-		-		-		-		-	
			12.7	0.59	12.2	0.63	11.7	0.66	11.5	0.67	-	-	-	-	-	-	-	-	-	-
3/4	580	4214	5960		5628		5234		4785		3159		-		-		-		-	
			13.5	0.65	13.1	0.69	12.7	0.73	12.5	0.75	10.9	0.69	-	-	-	-	-	-	-	-
1	600	4359	6188		5870		5498		5076		3889		-		-		-		-	
			14.2	0.71	13.8	0.76	13.4	0.80	13.2	0.82	12.0	0.80	-	-	-	-	-	-	-	-
1	620	4504	6415		6107		5756		5363		4304		-		-		-		-	
			14.9	0.78	14.6	0.83	14.2	0.87	13.8	0.90	12.9	0.90	-	-	-	-	-	-	-	-
1	638	4635	6631		6330		5990		5625		4635		-		-		-		-	
			15.4	0.85	15.0	0.90	14.6	0.94	14.3	0.98	13.5	0.99	-	-	-	-	-	-	-	-
1 1/2	660	4795	6868		6577		6264		5913		5018		-		-		-		-	
			15.9	0.94	15.7	0.99	15.2	1.04	14.8	1.07	14.2	1.10	-	-	-	-	-	-	-	-
1 1/2	685	4976	7150		6869		6578		6248		5461		4209		-		-		-	
			16.7	1.04	16.4	1.10	16.0	1.15	15.6	1.19	15.0	1.24	13.8	1.17	-	-	-	-	-	-
1 1/2	705	5122	7374		7101		6827		6506		5782		4753		-		-		-	
			17.4	1.13	17.1	1.19	16.7	1.24	16.3	1.29	15.7	1.34	14.7	1.31	-	-	-	-	-	-
1 1/2	731	5311	7666		7403		7144		6839		6161		5247		-		-		-	
			18.4	1.26	18.1	1.32	17.7	1.38	17.4	1.42	16.7	1.49	15.8	1.48	-	-	-	-	-	-
2	750	5449	7879		7622		7369		7080		6434		5583		4127		-		-	
			19.0	1.35	18.7	1.42	18.4	1.48	18.0	1.53	17.4	1.60	16.6	1.61	15.0	1.49	-	-	-	-
2	770	5594	8103		7853		7605		7332		6719		5932		4856		-		-	
			19.6	1.46	19.3	1.53	18.9	1.59	18.5	1.64	17.9	1.72	17.3	1.76	16.0	1.67	-	-	-	-
2	785	5703	8270		8025		7782		7521		6925		6200		5250		-		-	
			20.0	1.54	19.8	1.62	19.4	1.68	18.9	1.73	18.3	1.82	17.8	1.86	16.6	1.81	-	-	-	-
2	804	5841	8482		8243		8004		7758		7183		6528		5628		-		-	
			21.0	1.66	20.0	1.73	19.9	1.80	19.5	1.85	18.8	1.94	18.4	2.00	17.3	1.97	-	-	-	-
3	830	6030	8772		8540		8308		8080		7534		6910		6092		4830		-	
			22.0	1.82	21.0	1.89	21.0	1.97	22.0	2.00	19.6	2.12	18.9	2.18	18.1	2.18	16.9	2.05	-	-
3	865	6284	9161		8938		8716		8497		7988		7415		6706		5853		-	
			23.0	2.05	23.0	2.13	22.0	2.21	22.0	2.27	21.0	2.38	20.0	2.46	19.7	2.49	18.6	2.43	-	-
3	895	6502	9493		9278		9063		8851		8372		7840		7239		6421		5162	
			25.0	2.26	24.0	2.35	24.0	2.43	23.0	2.50	22.0	2.61	22.0	2.70	21.0	2.75	20.0	2.73	18.4	2.56
3	921	6691	9782		9573		9364		9156		8702		8195		7624		6881		6055	
			26.0	2.46	26.0	2.55	25.0	2.63	25.0	2.71	24.0	2.82	23.0	2.93	23.0	2.99	22.0	2.99	20.0	2.90
5	960	6974	10213		10013		9812		9612		9193		8720		8189		7568		6816	
			28.0	2.78	27.0	2.87	27.0	2.96	26.0	3.04	25.0	3.17	25.0	3.28	24.0	3.36	24.0	3.40	22.0	3.36
5	1000	7265	10655		10463		10270		10078		9691		9239		8757		8221		7523	
			30.0	3.14	29.0	3.23	29.0	3.32	28.0	3.41	27.0	3.55	26.0	3.67	26.0	3.77	25.0	3.83	24.0	3.83
5	1045	7592	11151		10967		10783		10599		10236		9814		9369		8875		8318	
			31.0	3.57	31.0	3.66	31.0	3.76	30.0	3.85	29.0	4.01	28.0	4.14	28.0	4.26	27.0	4.34	26.0	4.39
5	1091	7926	11658		11482		11305		11129		10780		10395		9981		9531		9039	
			34.0	4.05	33.0	4.15	33.0	4.25	33.0	4.35	31.0	4.53	31.0	4.66	30.0	4.80	29.0	4.91	29.0	4.96

Performance shown is for installation type A: Free Inlet, Free Outlet. Power rating (BHP) does not include drive losses. For further information on estimating belt drive losses and motor service factors see page 11. The sound ratings shown are for loudness values in fan sones at 5'0" (1.5m) in a hemispherical free field per AMCA Standard 301. Values shown are for installation Type A: free inlet sone levels. Performance ratings do not include the effects of appurtenances in the airstream.

Dimensional Information & Performance Data

Fumex | Belt Drive



FX30B

Centrifugal Fans

FX30B Belt Drive Fan Curves

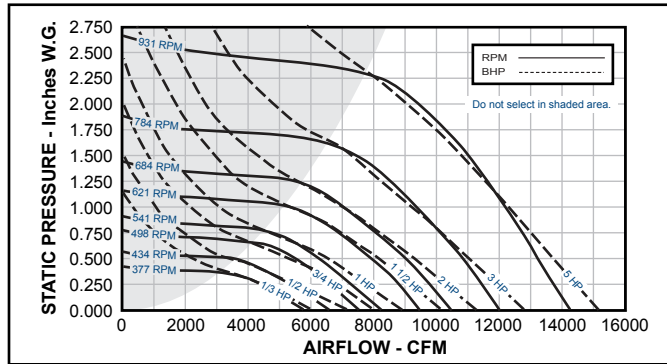

FX30B Belt Drive Fan Dimensional Data

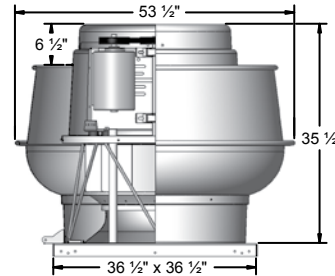

Galv. Steel Base = 14 Gage	Roof Opening = 28" SQ.	Peak BHP = (RPM/539) ³
Aluminum Base = 0.080	Damper Size = 27 1/4" SQ.	Max. RPM = 1188 (5 HP)
Discharge Apron = 0.080	Max. Motor Frame Size = 184T	Est. Ship Weight = 219 lbs.*

* Add 65 lbs. for Heat & Smoke option.

FX30B Belt Drive Fan Performance Data

HP	RPM	Tip Speed FPM	0.000" SP		0.250" SP		0.500" SP		0.750" SP		1.000" SP		1.250" SP		1.500" SP		1.750" SP		2.000" SP		2.250" SP		
			Sones	BHP	Sones	BHP	Sones	BHP	Sones	BHP	Sones	BHP	Sones	BHP	Sones	BHP	Sones	BHP	Sones	BHP	Sones	BHP	Sones
1/3	347	2782	5314	3779	-	-	-	-	-	-	-	-	-	-	-	-	-	-	-	-	-	-	-
	377	3023	5773	4431	-	-	-	-	-	-	-	-	-	-	-	-	-	-	-	-	-	-	-
1/2	400	3207	6125	4899	-	-	-	-	-	-	-	-	-	-	-	-	-	-	-	-	-	-	-
	420	3367	6431	5283	-	-	-	-	-	-	-	-	-	-	-	-	-	-	-	-	-	-	-
	434	3480	6646	5548	3742	-	-	-	-	-	-	-	-	-	-	-	-	-	-	-	-	-	-
3/4	455	3648	6968	5937	4445	-	-	-	-	-	-	-	-	-	-	-	-	-	-	-	-	-	-
	480	3848	7350	6377	5078	-	-	-	-	-	-	-	-	-	-	-	-	-	-	-	-	-	-
	498	3993	7626	6690	5505	-	-	-	-	-	-	-	-	-	-	-	-	-	-	-	-	-	-
1	520	4169	7963	7069	5984	-	-	-	-	-	-	-	-	-	-	-	-	-	-	-	-	-	-
	541	4338	8285	7428	6433	4939	-	-	-	-	-	-	-	-	-	-	-	-	-	-	-	-	-
1 1/2	560	4490	8576	7748	6818	5514	-	-	-	-	-	-	-	-	-	-	-	-	-	-	-	-	-
	595	4770	9112	8333	7491	6397	-	-	-	-	-	-	-	-	-	-	-	-	-	-	-	-	-
	621	4979	9510	8764	7983	6985	5581	-	-	-	-	-	-	-	-	-	-	-	-	-	-	-	-
2	640	5131	9801	9077	8335	7397	6193	-	-	-	-	-	-	-	-	-	-	-	-	-	-	-	-
	665	5332	10184	9488	8776	7930	6835	-	-	-	-	-	-	-	-	-	-	-	-	-	-	-	-
	684	5484	10474	9798	9109	8314	7311	5817	-	-	-	-	-	-	-	-	-	-	-	-	-	-	-
3	710	5693	10873	10221	9560	8817	7911	6748	-	-	-	-	-	-	-	-	-	-	-	-	-	-	-
	730	5853	11179	10545	9905	9199	8347	7299	-	-	-	-	-	-	-	-	-	-	-	-	-	-	-
	750	6013	11485	10869	10248	9578	8777	7806	6405	-	-	-	-	-	-	-	-	-	-	-	-	-	-
	770	6174	11792	11191	10588	9953	9202	8305	7144	-	-	-	-	-	-	-	-	-	-	-	-	-	-
	784	6286	12006	11416	10824	10211	9487	8630	7591	-	-	-	-	-	-	-	-	-	-	-	-	-	-
5	805	6454	12328	11753	11177	10582	9895	9090	8132	-	-	-	-	-	-	-	-	-	-	-	-	-	-
	840	6735	12863	12313	11761	11196	10566	9844	9011	7982	-	-	-	-	-	-	-	-	-	-	-	-	-
	880	7055	13476	12951	12424	11889	11322	10674	9918	9049	7955	-	-	-	-	-	-	-	-	-	-	-	-
	915	7336	14012	13507	13000	12491	11963	11351	10673	9923	9018	7663	-	-	-	-	-	-	-	-	-	-	-
	931	7464	14257	13760	13263	12764	12245	11658	11015	10285	9427	8352	-	-	-	-	-	-	-	-	-	-	-

Performance shown is for installation type A: Free Inlet, Free Outlet. Power rating (BHP) does not include drive losses. For further information on estimating belt drive losses and motor service factors see page 11. The sound ratings shown are for loudness values in fan sones at 5'0" (1.5m) in a hemispherical free field per AMCA Standard 301. Values shown are for installation Type A: free inlet sone levels. Performance ratings do not include the effects of appurtenances in the airstream.

©PENN BARRY 2009

FUMEX

› FX36B Belt Drive Fan Curves

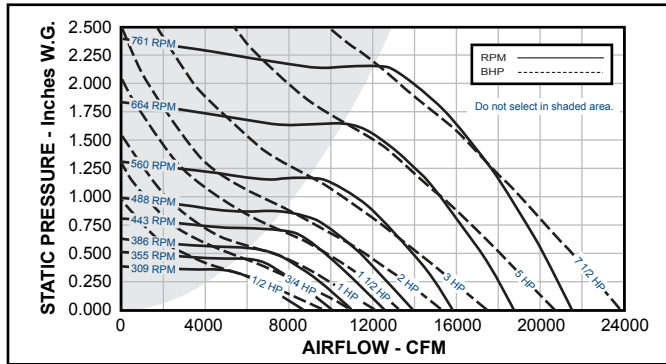

› FX36B Belt Drive Fan Dimensional Data

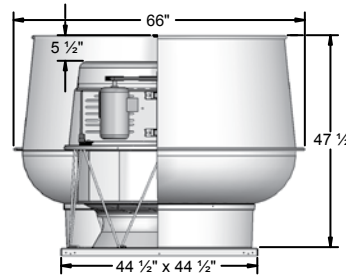

Galv. Steel Base = 12 Gage	Roof Opening = 36" SQ.	Peak BHP = (RPM/384) ³
Aluminum Base = 0.102	Damper Size = 35 1/2" SQ.	Max. RPM = 810 (7 1/2 HP)
Discharge Apron = 0.080	Max. Motor Frame Size = 213T	Est. Ship Weight = 470 lbs.*

* Add 110 lbs. for Heat & Smoke option.

› FX36B Belt Drive Fan Performance Data

HP	RPM	Tip Speed FPM	0.000" SP		0.250" SP		0.500" SP		0.750" SP		1.000" SP		1.250" SP		1.375" SP		1.500" SP		1.750" SP		2.000" SP		
			Sones	BHP	Sones	BHP	Sones	BHP	Sones	BHP	Sones	BHP	Sones	BHP	Sones	BHP	Sones	BHP	Sones	BHP	Sones	BHP	Sones
1/2	269	2619	7603	4897	-	-	-	-	-	-	-	-	-	-	-	-	-	-	-	-	-	-	-
	309	3008	5.6 0.25	5.4 0.34	-	-	-	-	-	-	-	-	-	-	-	-	-	-	-	-	-	-	-
3/4	335	3261	8.734	6761	-	-	-	-	-	-	-	-	-	-	-	-	-	-	-	-	-	-	-
	355	3456	7.2 0.37	6.8 0.51	-	-	-	-	-	-	-	-	-	-	-	-	-	-	-	-	-	-	-
1	370	3602	9.469	7715	-	-	-	-	-	-	-	-	-	-	-	-	-	-	-	-	-	-	-
	386	3758	8.4 0.48	7.8 0.63	-	-	-	-	-	-	-	-	-	-	-	-	-	-	-	-	-	-	-
1 1/2	405	3943	10.034	8409	-	-	-	-	-	-	-	-	-	-	-	-	-	-	-	-	-	-	-
	420	4089	10.9 0.73	10.0 0.92	-	-	-	-	-	-	-	-	-	-	-	-	-	-	-	-	-	-	-
2	443	4313	11.8 0.84	11.0 1.04	-	-	-	-	-	-	-	-	-	-	-	-	-	-	-	-	-	-	-
	465	4527	11.872	10531	-	-	-	-	-	-	-	-	-	-	-	-	-	-	-	-	-	-	-
3	488	4751	12.6 0.94	11.8 1.15	-	-	-	-	-	-	-	-	-	-	-	-	-	-	-	-	-	-	-
	500	4868	12.522	11255	-	-	-	-	-	-	-	-	-	-	-	-	-	-	-	-	-	-	-
5	515	5014	14.0 1.10	13.1 1.32	-	-	-	-	-	-	-	-	-	-	-	-	-	-	-	-	-	-	-
	530	5160	13.144	11941	-	-	-	-	-	-	-	-	-	-	-	-	-	-	-	-	-	-	-
7 1/2	550	5355	15.0 1.27	14.2 1.51	-	-	-	-	-	-	-	-	-	-	-	-	-	-	-	-	-	-	-
	560	5452	13.794	12653	-	-	-	-	-	-	-	-	-	-	-	-	-	-	-	-	-	-	-
7 1/2	580	5647	16.3 1.47	15.5 1.72	-	-	-	-	-	-	-	-	-	-	-	-	-	-	-	-	-	-	-
	600	5841	14.133	13022	-	-	-	-	-	-	-	-	-	-	-	-	-	-	-	-	-	-	-
7 1/2	620	6036	17.3 1.58	16.5 1.84	-	-	-	-	-	-	-	-	-	-	-	-	-	-	-	-	-	-	-
	640	6231	14.557	13483	-	-	-	-	-	-	-	-	-	-	-	-	-	-	-	-	-	-	-
7 1/2	664	6464	18.3 1.73	17.5 2.00	-	-	-	-	-	-	-	-	-	-	-	-	-	-	-	-	-	-	-
	680	6620	14.981	13942	-	-	-	-	-	-	-	-	-	-	-	-	-	-	-	-	-	-	-
7 1/2	700	6815	18.8 1.88	18.1 2.17	-	-	-	-	-	-	-	-	-	-	-	-	-	-	-	-	-	-	-
	720	7010	15.547	14552	-	-	-	-	-	-	-	-	-	-	-	-	-	-	-	-	-	-	-
7 1/2	745	7253	19.4 2.11	18.7 2.42	-	-	-	-	-	-	-	-	-	-	-	-	-	-	-	-	-	-	-
	761	7409	15.829	14855	-	-	-	-	-	-	-	-	-	-	-	-	-	-	-	-	-	-	-
7 1/2	775	7599	19.8 2.22	19.1 2.54	-	-	-	-	-	-	-	-	-	-	-	-	-	-	-	-	-	-	-
	790	7794	16.395	15460	-	-	-	-	-	-	-	-	-	-	-	-	-	-	-	-	-	-	-
7 1/2	805	7989	21.0 2.47	20.0 2.82	-	-	-	-	-	-	-	-	-	-	-	-	-	-	-	-	-	-	-
	820	8184	16.960	16063	-	-	-	-	-	-	-	-	-	-	-	-	-	-	-	-	-	-	-
7 1/2	835	8379	22.0 2.73	22.0 3.10	-	-	-	-	-	-	-	-	-	-	-	-	-	-	-	-	-	-	-
	850	8574	17.525	16663	-	-	-	-	-	-	-	-	-	-	-	-	-	-	-	-	-	-	-
7 1/2	865	8769	24.0 3.02	24.0 3.41	-	-	-	-	-	-	-	-	-	-	-	-	-	-	-	-	-	-	-
	880	8964	18.091	17262	-	-	-	-	-	-	-	-	-	-	-	-	-	-	-	-	-	-	-
7 1/2	895	9159	25.0 3.32	25.0 3.74	-	-	-	-	-	-	-	-	-	-	-	-	-	-	-	-	-	-	-
	910	9354	18.769	17978	-	-	-	-	-	-	-	-	-	-	-	-	-	-	-	-	-	-	-
7 1/2	925	9549	26.0 3.71	26.0 4.17	-	-	-	-	-	-	-	-	-	-	-	-	-	-	-	-	-	-	-
	940	9744	19.221	18453	-	-	-	-	-	-	-	-	-	-	-	-	-	-	-	-	-	-	-
7 1/2	955	9939	27.0 3.98	26.0 4.47	-	-	-	-	-	-	-	-	-	-	-	-	-	-	-	-	-	-	-
	970	10134	19.787	19047	-	-	-	-	-	-	-	-	-	-	-	-	-	-	-	-	-	-	-
7 1/2	985	10329	28.0 4.34	27.0 4.86	-	-	-	-	-	-	-	-	-	-	-	-	-	-	-	-	-	-	-
	1000	10524	20.352	19639	-	-	-	-	-	-	-	-	-	-	-	-	-	-	-	-	-	-	-
7 1/2	1015	10719	29.0 4.72	29.0 5.28	-	-	-	-	-	-	-	-	-	-	-	-	-	-	-	-	-	-	-
	1030	10914	21.059	20372	-	-	-	-	-	-	-	-	-	-	-	-	-	-	-	-	-	-	-
7 1/2	1045	11109	31.0 5.23	31.0 5.81	-	-	-	-	-	-	-	-	-	-	-	-	-	-	-	-	-	-	-
	1060	11304	21.511	20839	-	-	-	-	-	-	-	-	-	-	-	-	-	-	-	-	-	-	-
7 1/2	1075	11499	32.0 5.58	32.0 6.17	-	-	-	-	-	-	-	-	-	-	-	-	-	-	-	-	-	-	-
	1090	11694	31.067	20067	-	-	-	-	-	-	-	-	-	-	-	-	-	-	-	-	-	-	-
7 1/2	1105	11889	29.0 6.42	29.0 7.03	-	-	-	-	-	-	-	-	-	-	-	-	-	-	-	-	-	-	-
	1120	12084	28.0 7.08	28.0 7.74	-	-	-	-	-	-	-	-	-	-	-	-	-	-	-	-	-	-	-

Performance shown is for installation type A: Free Inlet, Free Outlet. Power rating (BHP) does not include drive losses. For further information on estimating belt drive losses and motor service factors see page 11. The sound ratings shown are for loudness values in fan sones at 50' (1.5m) in a hemispherical free field per AMCA Standard 301. Values shown are for installation Type A: free inlet sone levels. Performance ratings do not include the effects of appurtenances in the airstream.

Dimensional Information & Performance Data

Fumex | Belt Drive



FMX50B

Centrifugal Fans

FMX50B Belt Drive Fan Curves

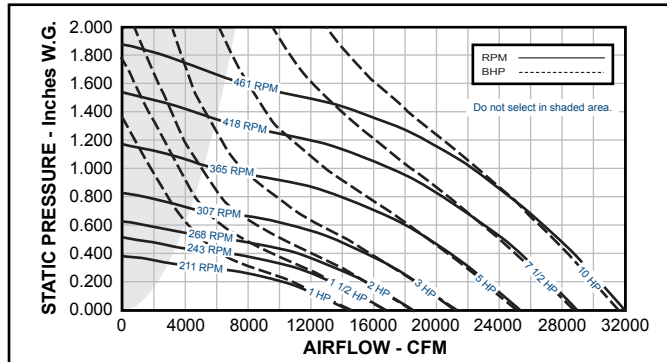

FMX50B Belt Drive Fan Dimensional Data

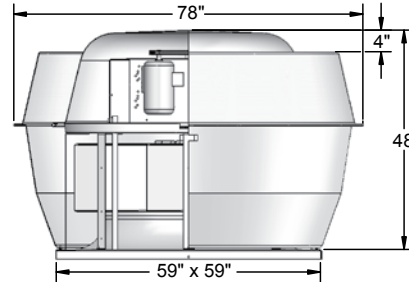

Galv. Steel Base = 12 Gage	Roof/Wall Opening = 50" SQ.	Peak BHP = (RPM/218) ³
Aluminum Base = 0.125	Damper Size = 49 1/2" SQ.	Max. RPM = 480 (10 HP)
Discharge Apron = 0.125	Max. Motor Frame Size = 215T	Est. Ship Weight = 928 lbs.

FMX50B Belt Drive Fan Performance Data

HP	RPM	Tip Speed FPM	0.000" SP		0.125" SP		0.250" SP		0.375" SP		0.500" SP		0.625" SP		0.750" SP		1.000" SP		1.250" SP		1.500" SP		
			Sones	BHP	Sones	BHP	Sones	BHP	Sones	BHP	Sones	BHP	Sones	BHP	Sones	BHP	Sones	BHP	Sones	BHP	Sones	BHP	Sones
1	190	2487	13139	6.8	0.72	10401	6.5	0.70	5367	-	-	-	-	-	-	-	-	-	-	-	-	-	-
	200	2618	13831	7.2	0.84	11276	6.9	0.83	7192	-	-	-	-	-	-	-	-	-	-	-	-	-	-
	211	2762	14592	7.6	0.99	12203	7.4	0.97	8861	-	-	-	-	-	-	-	-	-	-	-	-	-	-
1 1/2	220	2880	15214	8.0	1.12	12950	7.8	1.11	9918	-	-	-	-	-	-	-	-	-	-	-	-	-	-
	230	3011	15906	8.5	1.28	13770	8.2	1.27	11062	5791	-	-	-	-	-	-	-	-	-	-	-	-	-
	243	3181	16805	9.0	1.51	14822	8.8	1.50	12317	8501	-	-	-	-	-	-	-	-	-	-	-	-	-
2	250	3272	17289	9.3	1.65	15382	9.1	1.64	12979	9596	-	-	-	-	-	-	-	-	-	-	-	-	-
	260	3403	17980	9.7	1.85	16177	9.6	1.85	13911	11040	5088	-	-	-	-	-	-	-	-	-	-	-	-
	268	3508	18534	10.0	2.03	16801	9.9	2.03	14645	11980	7391	-	-	-	-	-	-	-	-	-	-	-	-
3	280	3665	19364	10.5	2.31	17705	10.5	2.31	15706	13357	9722	-	-	-	-	-	-	-	-	-	-	-	-
	290	3796	20055	11.1	2.57	18454	11.1	2.57	16553	14357	11285	5511	-	-	-	-	-	-	-	-	-	-	-
	300	3927	20747	11.6	2.84	19198	11.6	2.84	17392	15313	12722	8370	-	-	-	-	-	-	-	-	-	-	-
	307	4019	21231	12.0	3.05	19718	11.9	3.04	17973	15973	13546	9768	-	-	-	-	-	-	-	-	-	-	-
5	320	4189	22130	12.6	3.45	20678	12.6	3.45	19043	17182	15047	11962	6637	-	-	-	-	-	-	-	-	-	-
	335	4385	23167	13.4	3.96	21781	13.4	3.96	20264	18552	16591	14175	10449	-	-	-	-	-	-	-	-	-	-
	350	4581	24205	14.2	4.52	22878	14.2	4.51	21470	19836	18021	15931	13019	-	-	-	-	-	-	-	-	-	-
	365	4778	25242	15.0	5.12	23969	14.9	5.12	22665	21098	19424	17624	15293	6502	-	-	-	-	-	-	-	-	-
7 1/2	380	4974	26279	15.8	5.78	25057	15.7	5.78	23835	22344	20802	19073	17057	10734	-	-	-	-	-	-	-	-	-
	395	5171	27317	16.6	6.49	26141	16.5	6.49	24965	23575	22128	20496	18779	13594	-	-	-	-	-	-	-	-	-
	410	5367	28354	17.4	7.26	27221	17.3	7.26	26088	24795	23400	21894	20292	15941	7763	-	-	-	-	-	-	-	-
	418	5472	28907	17.9	7.69	27796	17.8	7.69	26865	25440	24072	22631	21059	17167	10010	-	-	-	-	-	-	-	-
10	425	5563	29391	18.2	8.09	28298	18.2	8.08	27206	26003	24657	23271	21725	18079	12030	-	-	-	-	-	-	-	-
	435	5694	30083	18.8	8.67	29015	18.8	8.67	27947	26802	25487	24173	22668	19255	13976	-	-	-	-	-	-	-	-
	445	5825	30774	19.3	9.28	29731	19.3	9.28	28687	27598	26312	25027	23601	20414	15733	7438	-	-	-	-	-	-	-
	455	5956	31466	19.9	9.92	30445	19.9	9.92	29424	28389	27132	25875	24525	21558	17298	10112	-	-	-	-	-	-	-
	461	6034	31881	20.0	10.32	30873	20.0	10.31	29866	28859	27622	26381	25076	22225	18224	11874	-	-	-	-	-	-	-
				20.0	10.32	30873	20.0	10.31	29866	28859	27622	26381	25076	22225	18224	11874	-	-	-	-	-	-	-

Performance shown is for installation type A: Free Inlet, Free Outlet. Power rating (BHP) does not include drive losses. For further information on estimating belt drive losses and motor service factors see page 11. The sound ratings shown are for loudness values in fan sones at 5'0" (1.5m) in a hemispherical free field per AMCA Standard 301. Values shown are for installation Type A: free inlet sone levels. Performance ratings do not include the effects of appurtenances in the airstream.

©PENN BARRY 2009

FUMEX

› Model

FX = Centrifugal Fan
 WFX = Wall Mounted Centrifugal Fan
 FMX = High Capacity Centrifugal Fan

› Unit Size

08	11	13	16	24	30	50
10	12	14	18	27	36	

› Drive Type

D = Direct Drive
 B = Belt Drive

› Motor Tap

Q = 1725 RPM
 R = 1550 RPM
 S = 1300 RPM
 V = 1050 RPM
 Q1 = 1650 RPM
 Q2 = 1725 RPM

› Motor Speed

1 = Single Speed
 2 = 2S2W Single & Three Phase
 3 = 2S1W Three Phase

› Horse Power

1/50	1/12	1/5	3/4	3
1/30	1/11	1/4	1	5
1/25	1/7	1/3	1 1/2	7 1/2
1/20	1/6	1/2	2	10

› Enclosure

O = Open Drip Proof
 T = Totally Enclosed
 E = Explosion Proof
 X = Special

› Voltage

A = 110V	G = 230V	N = 440V
B = 115V	H = 240V	P = 460V
C = 120V	J = 277V	Q = 480V
D = 200V	K = 380V	R = 575V
E = 208V	L = 400V	S = 600V
F = 220V	M = 415V	X = Special

› Phase

1 = Single
 3 = Three

› Cycle

5 = 50 Hz
 6 = 60 Hz

› Efficiency

S = Standard
 H = High Efficiency

› Paint / Coating

Sizes 08 - 36

0 = None
 F = Epoxy Powder Coat*
 G = Epoxy Powder Coat with UV*
 H = Hi-Temp Powder Coat*
 J = Non-stick Powder Coat*
 K = Phenolic Powder Coat*
 L = Phenolic Powder Coat with UV*
 N = Polyester Powder Coat
 X = Special
 * Not available with choice of color.

Size 50

0 = None
 B = Epoxy*
 C = Heresite*
 D = Heresite with UV*
 Q = Enamel*
 X = Special
 * Not available with choice of color.

› Color

0 = None
 50 = Chrome Green
 53 = Williamsburg Blue
 55 = Pale Green
 56 = Dove Gray
 61 = White
 63 = Oxford Beige
 65 = Dover White
 66 = Desert Tan
 70 = Black
 73 = Smoke Gray
 77 = Brick Red
 79 = Peppercorn
 81 = Pale Brown
 83 = Chocolate Brown
 85 = Timeless Bronze
 94 = Charcoal
 X = Special

› AMCA Spark Rating

0 = None
 C = Standard
 B = Optional

› Damper

0 = None
 BDD = Gravity Backdraft Damper
 MD1 = Gravity Backdraft Damper 115V
 MD2 = Gravity Backdraft Damper 230V
 MD4 = Gravity Backdraft Damper 460V
 ED1 = Explosion Proof Motor Operated Damper 115V

› Screen

0 = None
 B = Bird Screen
 S = Insect/Bird Screen

› Roof Curb

0 = None	K = UCA18	V = UG18
A = UCG8	L = UG12	W = URA12
B = UCG12	M = SA16	Y = URA18
C = UCG18	N = SFG12	1 = URG12
D = UCA8	P = SFG18	10 = SFA8
E = UCA12	Q = SG16	11 = USCG
F = SFA12	R = SRA16	12 = USCA
G = SFA18	S = SRG16	2 = URG18
H = SCG16	T = UA12	4 = UVA18
J = SCA16	U = UA18	5 = UVG18

› Slope

0 = None
 S = Single
 D = Double

› Metal Liner

0 = None
 L = Metal Liner

› Damper Holding Plate

0 = None
 P = Damper Holding Plate

› Neoprene Gasket

0 = None
 G = Gasket

› No Wooden Nailer

0 = None
 N = No Wooden Nailer

› Curb Paint/Coating

B = Air Dried Epoxy
 Q = Enamel

› Hinged Sub-base

0 = None
 H = Hinged Sub-base

› Mounting Pedestal

0 = None
 P = Mounting Pedestal

› Floating Hinge Kit

0 = None
 H = Floating Hinge Kit

› Aluminum Base

0 = None
 A = Aluminum Base

› Thermal Overload Protection

0 = None
 P = Thermal Overload Protection

Continued, next page.

Engineering Specifications

Centrifugal Fans

› Disconnect Switch

- 0 = None
- 1 = NEMA 1 Disconnect Switch
- 3R = NEMA 3R Disconnect Switch
- 4 = NEMA 4 Disconnect Switch
- 7 = NEMA 7 Disconnect Switch
- 9 = NEMA 9 Disconnect Switch

› Internal Wiring

- 0 = None
- 1 = NEMA 4 Internal Wiring
- 3R = NEMA 3R Internal Wiring

› Transformer

- 0 = None
- T = Transformer

› Speed Controller

- 0 = None
- L = Loose
- M = Mounted

› Firestat Switch

- 0 = None
- F = Firestat Switch

› Fatrap

- 0 = None
- F = Fatrap

› Heat & Smoke Removal

- 0 = None
- HS = Heat & Smoke Removal

› Wall Mount

- 0 = None
- W = Wall Mount

› High Pressure Wheel

- 0 = None
- H = High Pressure Wheel

› High Wind Construction

- 0 = None
- M = Miami Dade Approved

› Belt Drive Fans

Belt drive centrifugal roof exhaust upblast fan shall be Fumex FX/FMX, manufactured by PennBarry, Richardson, TX 75081. The housing shall be weatherproof, utilize heavy-gauge spun aluminum construction with a large rolled bead for strength, with galvanized (aluminum optional except FMX) base, with rigid galvanized steel internal support structures. Housing shall not provide any of the internal structural support. Large diameter cooling tube shall provide ambient air to flow over motor. Units shall be equipped with an oversized electrical conduit chase through the curb cap and into the motor compartment for ease of wiring (except Explosion Proof). Units shall be prewired to a junction box mounted in the motor compartment and equipped with an electrical disconnect device (except Explosion Proof).

Statically and dynamically balanced backward inclined, centrifugal wheels shall be aluminum, spark-resistant, nonoverloading, and be matched to deeply spun venturis. Motors shall be continuous duty, ball bearing design, permanently lubricated, mounted out of the main airstream, and furnished at the specified voltage, phase, and enclosure. Shafts shall be turned, ground and polished. Heavy duty ball bearings are rated for a minimum L50 life exceeding 200,000 hours. Pulleys shall be adjustable, cast iron, machined, keyed, securely attached, and sized for 150% of the horsepower at its rated maximum speed. Each fan shall bear the AMCA Certified Ratings Seal for Air and Sound Performance (FX) or for Air performance (FMX), and shall be UL (UL Std. 705, UL Std. 762 optional) and CSA listed. If specified (Fatrap option), fan shall additionally provide UL 762 Listing rated at 400° F. (300° F. FMX), motor pre-wired to a weather-proof junction box, and drain connection leading into a grease collector/separator box. If specified (heat and smoke removal option), fan shall additionally provide UL listing rated for 500°F at 4-hours and 1000°F at 1 hour, including steel wheel and additional cooling tube.

› Direct Drive Fans

Direct drive centrifugal roof exhaust upblast fan shall be Fumex FX, manufactured by PennBarry, Richardson, TX 75081. The housing shall be weatherproof, utilize heavy gauge spun aluminum construction with a large rolled bead for strength, with galvanized (aluminum optional) base, with rigid galvanized steel internal support structures. Housing shall not provide any of the internal structural support. Units shall be equipped with an oversized electrical conduit chase through the curb cap and into the motor compartment for ease of wiring (except Explosion Proof). Units shall be pre-wired to a junction box mounted in the motor compartment and equipped with an electrical disconnect device (except Explosion Proof).

Statically and dynamically balanced backward inclined, centrifugal wheels shall be aluminum, spark-resistant, nonoverloading, and matched to deeply spun venturis. Motors shall be continuous duty, permanently lubricated, multispeed (for applicable models), have thermal overload protection, mounted out of the main airstream, be easily accessible for service, and furnished at the specified voltage, phase and enclosure. Each fan shall bear the AMCA Certified Ratings Seal for Air and Sound Performance, and shall be UL (UL Std. 705, UL Std. 762 optional applicable models) and CSA listed. If specified (Fatrap option), fan shall additionally provide UL 762 Listing rated at 400° F., motor pre-wired to a weather-proof junction box, and drain connection leading into a grease collector/separator box.

› Product Configuration

Reference PennBarry's selection software to configure a Fumex product today.

F
u
m
e
x

1-Year Limited Manufacturer Warranty

› Products Covered

PennBarry Fans and Ventilators (each, a “PennBarry Product”)

› One Year Limited Warranty For PennBarry Products

PennBarry warrants to the original commercial purchaser that the PennBarry Products will be free from defects in material and workmanship for a period of one (1) year from the date of shipment.

› Exclusive Remedy

PennBarry will, at its option, repair or replace (without removal or installation) the affected components of any defective PennBarry Product; repair or replace (without removal or installation) the entire defective PennBarry Product; or refund the invoice price of the PennBarry Product. In all cases, a reasonable time period must be allowed for warranty repairs to be completed.

› What You Must Do

In order to make a claim under these warranties:

- You must be the original commercial purchaser of the PennBarry Product.
- You must promptly notify us, within the warranty period, of any defect and provide us with any substantiation that we may reasonably request.
- The PennBarry Product must have been installed and maintained in accordance with good industry practice and any specific PennBarry recommendations.

› Exclusions

These warranties do not cover defects caused by:

- Improper design or operation of the system into which the PennBarry Product is incorporated.
- Improper installation.
- Accident, abuse or misuse.
- Unreasonable use (including any use for non-commercial purposes, failure to provide reasonable and necessary maintenance as specified by PennBarry, misapplication and operation in excess of stated performance characteristics).
- Components not manufactured by PennBarry.

› Limitations

- In all cases, PennBarry reserves the right to fully satisfy its obligations under the Limited Warranties by refunding the invoice price of the defective PennBarry Product (or, if the PennBarry Product has been discontinued, of the most nearly comparable current product).
- PennBarry reserves the right to furnish a substitute or replacement component or product in the event a PennBarry Product or any component of the product is discontinued or otherwise unavailable.
- PennBarry’s only obligation with respect to components not manufactured by PennBarry shall be to pass through the warranty made by the manufacturer of the defective component.

› General

The foregoing warranties are exclusive and in lieu of all other warranties except that of title, whether written, oral or implied, in fact or in law (including any warranty of merchantability or fitness for a particular purpose).

PennBarry hereby disclaims any liability for special, punitive, indirect, incidental or consequential damages, including without limitation lost profits or revenues, loss of use of equipment, cost of capital, cost of substitute products, facilities or services, downtime, shutdown or slowdown costs.

The remedies of the original commercial purchaser set forth herein are exclusive and the liability of PennBarry with respect to the PennBarry Products, whether in contract, tort, warranty, strict liability or other legal theory shall not exceed the invoice price charged by PennBarry to its customer for the affected PennBarry Product at the time the claim is made.

Inquiries regarding these warranties should be sent to: PennBarry, 1401 North Plano Road, Richardson, TX 75081

Other PennBarry Products

Centrifugal Products



› **Domex**
Centrifugal
Roof Exhausters



› **Fumex Fatrap**
Kitchen Hood Centrifugal
Roof Exhausters



› **Zephyr**
Ceiling and Inline Fans

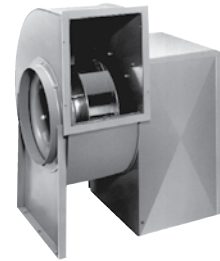

› **Dynamo**
Centrifugal Blowers

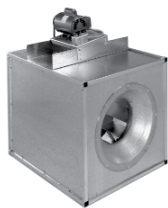

› **Centrex Inliner**
Centrifugal Inline Fan



› **LC Dynafan**
Low Contour Centrifugal
Roof Exhausters



› **ESI**
Efficient Silent
Inline Fan



› **Fume Exhaust**
Curb Mounted
Centrifugal Fans

Axial / Gravity Products

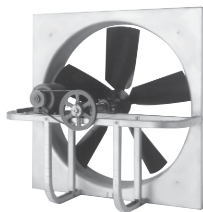

› **Breezeway**
Propeller Wall Fan



› **Hi-Ex**
Power Roof Ventilator

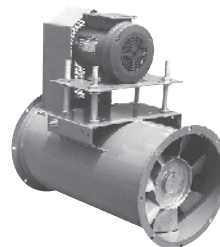

› **Tubeaxial**
Inline Fans



› **Vaneaxial**
Inline Fans

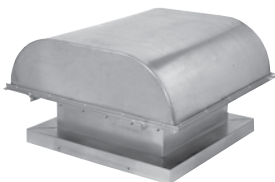

› **Powered Airette**
Axial Roof Ventilators

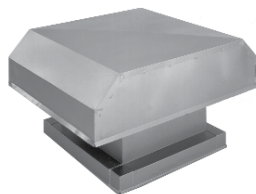

› **Airette**
Gravity Intake/Relief Hood



› **Domex Axial**
Axial Roof Ventilators



› **Axcentrix**
Bifurcator Fan

